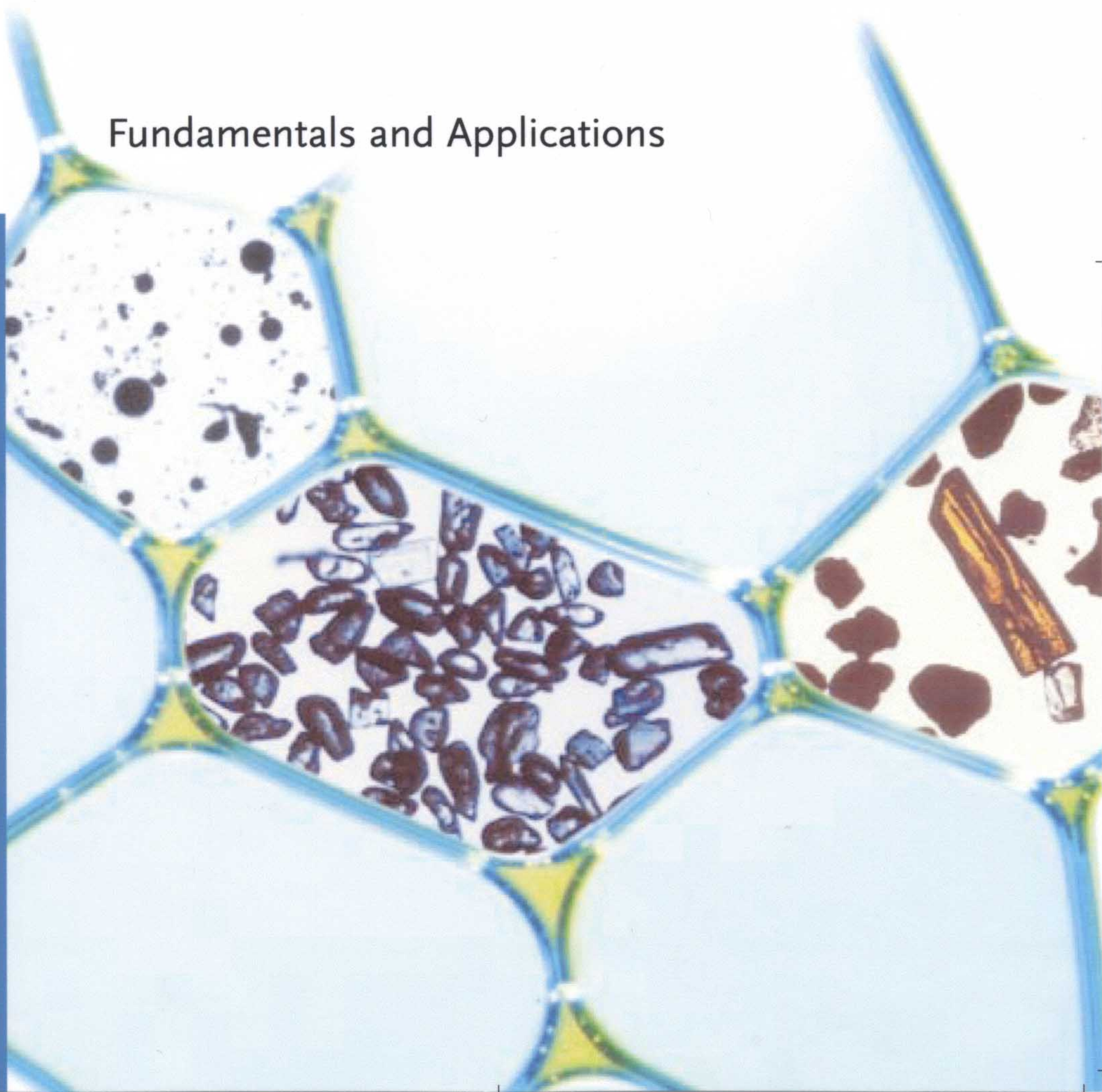


Laurier L. Schramm

 WILEY-VCH

# Emulsions, Foams, and Suspensions

Fundamentals and Applications



*L. L. Schramm*  
**Emulsions, Foams,  
and Suspensions**

## *Further Titles of Interest*

T. F. Tadros

### **Applied Surfactants**

**Principles and Applications**

2005

ISBN 3-527-30629-3

E. Smulders

### **Laundry Detergents**

2002

ISBN 3-527-30520-3

H. Sixta (Ed.)

### **Handbook of Pulp**

2006

ISBN 3-527-30999-3

H. Holik (Ed.)

### **Handbook of Paper and Board**

2006

ISBN 3-527-30997-7

F. H. Prager, H. Rosteck

### **Polyurethane and Fire**

**Fire Performance Testing under Real Conditions**

2006

ISBN 3-527-30805-9

J. G. Brennan (Ed.)

### **Food Processing Handbook**

2006

ISBN 3-527-30719-2

*Laurier L. Schramm*

# **Emulsions, Foams, and Suspensions**

Fundamentals and Applications



**WILEY-  
VCH**

WILEY-VCH Verlag GmbH & Co. KGaA

**Author**

***Dr. Laurier L. Schramm***

President and CEO  
Saskatchewan Research Council  
15 Innovation Blvd.  
Saskatoon, SK  
Canada S7N 2X8

All books published by Wiley-VCH are carefully produced. Nevertheless, authors, editors, and publisher do not warrant the information contained in these books, including this book, to be free of errors. Readers are advised to keep in mind that statements, data, illustrations, procedural details or other items may inadvertently be inaccurate.

**Library of Congress Card No.:** applied for

**British Library Cataloguing-in-Publication Data**

A catalogue record for this book is available from the British Library.

**Bibliographic information published by**

**Die Deutsche Bibliothek**

Die Deutsche Bibliothek lists this publication in the Deutsche Nationalbibliografie; detailed bibliographic data is available in the Internet at <<http://dnb.ddb.de>>.

© 2005 WILEY-VCH Verlag GmbH & Co. KGaA, Weinheim

All rights reserved (including those of translation into other languages).

No part of this book may be reproduced in any form – nor transmitted or translated into machine language without written permission from the publishers. Registered names, trademarks, etc. used in this book, even when not specifically marked as such, are not to be considered unprotected by law.

Printed in the Federal Republic of Germany.

Printed on acid-free paper.

**Typesetting** Kühn & Weyh, Satz und Medien, Freiburg

**Printing** Strauss GmbH, Mörlenbach

**Bookbinding** Litges & Dopf Buchbinderei GmbH, Heppenheim

**ISBN-13:** 978-3-527-30743-2

**ISBN-10:** 3-527-30743-5

*To Ann Marie, William, Joan, Kent, Katherine and Victoria*



## Contents

Preface XIII

<b>1</b>	<b>Introduction</b>	<b>1</b>
1.1	The Colloidal State	1
1.2	Classification of Emulsions, Foams, and Suspensions	4
1.2.1	Emulsions	4
1.2.2	Foams	7
1.2.3	Suspensions	9
1.3	Characterization and Stability	11
<b>2</b>	<b>Dispersion and Dispersed Species Characterization</b>	<b>13</b>
2.1	Surface Area, Porosity, and Permeability	13
2.2	Size and Size Distribution	18
2.2.1	Microscopy	20
2.2.2	Sieving	23
2.2.3	Radiation Scattering	24
2.2.4	Ultramicroscopy	26
2.2.5	Other Techniques	27
2.3	Conductivity	28
2.3.1	Dispersed Phase Identification	28
2.3.2	Sensing-zone Techniques	28
2.3.3	Conductivity of Dispersions	29
2.4	Sedimentation, Creaming, and Centrifugation	30
2.4.1	Sedimentation and Creaming	30
2.4.2	Centrifugation and Ultracentrifugation	38
2.5	Characterization of Emulsions	41
2.5.1	Appearance and Emulsion Type	41
2.5.2	Experimental Assessment of Emulsion Stability	43
2.5.3	Composition	44
2.6	Characterization of Foams	44
2.6.1	Appearance and Foam Type	44
2.6.2	Experimental Assessment of Foam Stability	47
2.7	Characterization of Suspensions	50



2.7.1	Chemical and Surface Analysis	50
2.7.2	Experimental Assessment of Suspension Stability	50
<b>3</b>	<b>Interfacial Energetics</b>	<b>53</b>
3.1	Surface Area	53
3.2	Surface and Interfacial Tensions	54
3.2.1	Principles	54
3.2.2	Equation of Young–Laplace	61
3.2.3	Measurement	61
3.2.4	Experimental Results for Dispersions	70
3.3	Pressure and Curved Surfaces	72
3.4	Contact Angle and Wettability	73
3.5	Surfactants and Micelles	76
3.5.1	Surface Activity	76
3.5.2	Classification and Analysis of Surfactants	80
3.5.3	Micelles	82
3.5.4	Surface Elasticity	86
3.6	Applications of Surface Activity	89
3.6.1	Surfactants and Emulsification	89
3.6.2	Surfactants and Foaming	91
3.6.3	Surfactants and Flotation	92
3.6.4	Surfactants and Suspensions	93
3.6.5	Surfactants and Wetting	94
3.6.6	Surfactants and Detergency	94
3.7	Other Lyophilic Colloids: Microemulsions	97
<b>4</b>	<b>Electrokinetics</b>	<b>101</b>
4.1	Charged Interfaces	101
4.2	Electric Double Layer	103
4.3	Electrokinetic Phenomena	105
4.3.1	Electrophoresis	109
4.3.2	Point of Zero Charge and Isoelectric Point	113
4.3.3	Electrodialysis	114
4.4	Electrostatic Properties in Non-aqueous Media	115
<b>5</b>	<b>Colloid Stability</b>	<b>117</b>
5.1	Electrostatic and Dispersion Forces	119
5.1.1	Repulsive Forces	120
5.1.2	Dispersion Forces	121
5.2	DLVO Theory and Practice	122
5.2.1	Theory	122
5.2.2	Practical Guidelines	128
5.2.3	Schulze–Hardy Rule	130
5.2.4	Peptization	132
5.3	Hydration and Steric Effects	132

5.3.1	Steric Stabilization	135
5.4	Additional Stabilizing Influences	137
5.4.1	Other Stabilizing Influences for Suspensions Stability	137
5.4.2	Other Influences on Emulsion Stability	138
5.4.3	Other Influences on Foam Stability	141
5.5	Kinetics	143
5.6	Destabilization of Colloids	146
5.6.1	Aggregation and Flocculation	147
5.6.2	Structures in Flocculation	148
5.6.3	Bridging Flocculation	149
5.6.4	Agglomeration Flocculation	151
5.6.5	Depletion Flocculation	151
5.6.6	Filtration	152
5.6.7	Foam Stability in the Presence of Oil	152
<b>6</b>	<b>Colloid Rheology</b>	<b>155</b>
6.1	Principles	156
6.2	Measurement	159
6.2.1	Tube Methods	160
6.2.2	Rotational methods	164
6.2.3	Other methods	167
6.3	Non-Newtonian Flow Properties	170
6.3.1	Pseudoplasticity	173
6.3.2	Dilatancy	174
6.3.3	Plasticity/Pseudoplasticity with Yield Stress	174
6.3.4	Thixotropy	176
6.3.5	Rheopexy	177
6.3.6	Viscoelasticity	178
6.3.7	Rheomalaxis	178
6.3.8	Summary	179
6.4	Other Viscosity Nomenclature and Parameters	179
6.4.1	Viscosity Nomenclature	179
6.4.2	Other Viscosity Parameters	180
6.4.3	Experimental Considerations	182
6.5	Dispersion Rheology	183
6.5.1	Einstein's Equation	183
6.5.2	Virial Expansions	186
6.5.3	Other Empirical Equations	188
6.5.4	Dispersed Phase Size and Polydispersity	188
6.5.5	Additional Considerations for Emulsions and Foams	189
6.5.6	Other Equations	192
6.6	Surface Rheology	193
6.7	Flow in Pipelines and Constraining Media	194
6.7.1	Applications in Pipeline Flow	194
6.7.2	Applications in Porous Media	197

<b>7</b>	<b>Preparation, Inhibition, and Destruction of Dispersions</b>	<b>201</b>
7.1	Preparation	202
7.1.1	Preparation of Emulsions	202
7.1.2	Preparation of Foams	209
7.1.3	Preparation of Suspensions	211
7.1.4	Ostwald Ripening	215
7.2	Destruction and/or Inhibition	215
7.2.1	Demulsification	215
7.2.2	Antifoaming and Defoaming	220
<b>8</b>	<b>Introduction to Practical and Industrial Applications</b>	<b>223</b>
8.1	General Uses	223
8.2	Emulsions	224
8.3	Foams	227
8.4	Suspensions	228
8.5	Hazards	229
<b>9</b>	<b>Applications in the Environment</b>	<b>231</b>
9.1	Introduction	231
9.2	Rocks, Sediments, and Soils	231
9.3	Environmental Soil Remediation	234
9.4	Water and Wastewater Treatment	236
9.5	Spills and Other Hazards	238
9.6	Environmental Foam Blankets	240
<b>10</b>	<b>Mining and Mineral Processing Applications</b>	<b>243</b>
10.1	Introduction	243
10.2	Hydraulic Mining and Hydrotransport	243
10.3	Mineral Flotation	245
10.3.1	Carrier, Emulsion, and Floc Flotation	257
10.4	Tailings and Tailings Ponds	258
10.5	Dust-Suppressing Foam Blankets	261
<b>11</b>	<b>Petroleum Industry Applications</b>	<b>263</b>
11.1	Oil Wells and Near Wells	265
11.1.1	Drilling and Completion Fluids	265
11.1.2	Well Stimulation: Fracturing and Acidizing	267
11.2	Reservoirs	268
11.2.1	Primary and Secondary Oil Recovery	268
11.2.2	Enhanced (Tertiary) Oil Recovery	270
11.3	Surface Operations	278
11.3.1	Surface Treatment	278
11.3.2	Oil Sands Processing	280
11.3.3	Pipeline Transportation	282
11.3.4	Upgraders and Refineries	283

<b>12</b>	<b>Manufacturing and Materials Science Applications</b>	<b>285</b>
12.1	Introduction	285
12.2	Papermaking	285
12.3	Emulsions for Road Paving	287
12.4	Metal-working	288
12.5	Cleaning Processes	289
12.5.1	Detergency	289
12.5.2	De-inking	292
12.6	Surface Coatings including Paints and Inks	294
12.7	Polymer Synthesis	297
12.8	Ceramics Manufacture	297
12.9	Fire-Fighting Foams	298
<b>13</b>	<b>Food Product and Agricultural Applications</b>	<b>301</b>
13.1	Introduction to Food Colloids	301
13.2	Stabilizing Agents	302
13.3	Preparation	304
13.4	Stability	304
13.5	Protein-stabilized Emulsions	306
13.5.1	Ice Cream	309
13.5.2	Cream Liqueurs	311
13.6	Non-protein-stabilized Emulsions	312
13.6.1	Carbonated Soft Drinks	314
13.7	Foam Food Products	314
13.7.1	Baked Products	315
13.7.2	Foam Toppings	316
13.7.3	Champagne and Beer Foams	317
13.7.4	Coffee Beverage Foam	318
13.8	Other Food Colloids	318
13.9	Introduction to Agricultural Colloids	321
<b>14</b>	<b>Biological and Medical Applications</b>	<b>325</b>
14.1	Introduction	325
14.2	Vesicle Carriers	329
14.3	Polymer Coatings	330
14.4	Emulsion Carriers	332
14.5	Colloids in Diagnostics	334
<b>15</b>	<b>Personal Care Product Applications</b>	<b>337</b>
15.1	Introduction	337
15.2	Detergents, Shampoos and Conditioners	338
15.3	Cosmetic Skin Care Products	339
15.4	Other Personal Care Products	344

**XII** | *Contents*

<b>16</b>	<b>Emerging Areas in Emulsions, Foams and Suspensions</b>	<b>347</b>
16.1	Smart Colloids	347
16.2	Nanodispersions	348
16.3	Combatting Terror Agents	353
<b>17</b>	<b>Glossary of Emulsion, Foam and Suspension Terminology</b>	<b>357</b>
17.1	Introduction	357
17.2	Terms	357
<b>18</b>	<b>References</b>	<b>401</b>
<b>Index</b>		<b>431</b>

## Preface

This book provides an introduction to the colloid and interface science of three of the most common types of colloidal dispersion: emulsions, foams, and suspensions. The initial emphasis covers basic concepts important to the understanding of most kinds of colloidal dispersions, not just emulsions, foams, and suspensions, and is aimed at providing the necessary framework for understanding the applications. The treatment is integrated; for each major physical property class the principles of colloid and interface science common to each dispersion type are presented first, followed as needed by separate treatments of features unique to emulsions, foams, or suspensions. The second half of the book provides examples of the applications of colloid science, again in the context of emulsions, foams, and suspensions, and includes attention to practical processes and problems in various industrial settings.

Colloid science books available up to now have been either principally theoretical (such as the classic and standard colloid chemistry texts), or they focus on specific types of colloidal dispersion (like van Olphen's classic book on clay colloid chemistry [1]), or on applications of a specific type of dispersion in a specific industry, like the author's petroleum industry series:

- Emulsions: Fundamentals and Applications in the Petroleum Industry [2],
- Foams: Fundamentals and Applications in the Petroleum Industry [3],
- Suspensions: Fundamentals and Applications in the Petroleum Industry [4],
- Surfactants: Fundamentals and Applications in the Petroleum Industry [5].

The applications of, or problems caused by emulsions, foams, and suspensions in industry area are quite diverse and have great practical importance. The different industrial application settings share some important common themes as well. Colloidal dispersions can be found, may require treatment, or may be applied to advantage throughout most, if not all, of the process industries. In each case the nature, properties, or even the presence or absence of these dispersions can determine both the economic and technical successes of the industrial process concerned. In this book, a wide range of application areas are summarized.

The book is aimed at scientists and engineers who may encounter or be able to use these dispersions, or their combinations, whether in process design, indus-

trial production, or in related research and development fields. It does not assume a prior knowledge of colloid chemistry and all terminology used is consistent with the definitions provided by the author's Dictionary of Colloid and Interface Science (Wiley, 2001). As such, it is hoped that the book will be of interest to senior undergraduate and graduate students in science and engineering as well since topics such as this are not normally part of university curricula.

While the first half of the book provides an introduction to needed basic principles, it does so in a very applications oriented manner, as the focus of this book is practical rather than theoretical. In Chapters 1 through 7 the reader is introduced to suspension formation and stability, characterization, and flow properties, emphasizing practical aspects throughout. The second half of the book explicitly focuses on industrial practise. Chapters 8 through 15 discuss the use or occurrence of emulsions, foams, and/or suspensions in the mineral processing, petroleum, petrochemical, manufacturing, environmental, agricultural, food, biological, health and personal care sectors. This selection of application areas, although inevitably incomplete, should provide some appreciation for the importance of emulsions, foams, and suspensions across a broad spectrum of industrial applications. Chapter 16 introduces some emerging areas in the field. Finally, the glossary in Chapter 17 contains substantive explanations for core terms used in the book, or that may be encountered in practise. Overall, the book shows how to approach making emulsions, foams, and suspensions, how their different properties arise, how to propagate them, and how to prevent their formation or destabilize them.

### **Acknowledgements**

This book evolved out of the course notes that were prepared for senior undergraduate- and graduate level courses on colloid and interface science that I taught throughout the 1990s at the University of Calgary. Its evolution benefited from the many questions and discussions prompted by the students in these courses. I am grateful to all those students for their enthusiasm, questioning, and interest. The preparation of this book was made possible through the support of my family, Ann Marie, Katherine and Victoria who, in addition to their support, gave me the time needed for the organization, research, and writing.

I am also very grateful to Elaine Stasiuk for having sacrificed so much of her leisure to read and comment on the manuscript of this book. Her many comments and suggestions have been very helpful, as have the many stimulating colloid and interface science discussions that we have had over the past ten years.

Even in today's electronic and Internet age there remains a need for major research libraries with substantive collections of scientific and engineering books and periodicals. In the preparation of this book my work was greatly assisted by the collections of the libraries of the University of Calgary, Carleton University, Dalhousie University, University of Alberta, Memorial University, University of

Saskatchewan, University of Regina, and the Canada Institute for Scientific and Technical Information.

I greatly appreciate the care and attention with which the staff at Wiley-VCH books handled all aspects of the development and production of this book. Thank you especially to Karin Sora, Rainer Muenz, and Peter Biel.

Saskatoon, May 2005

*Laurier L. Schramm*





# 1

## Introduction

### 1.1

#### The Colloidal State

A colloidal dispersion comprises a collection of small particles, droplets, or bubbles of one phase, having at least one dimension between about 1 and 1000 nm, and dispersed in a second phase. Either or both phases may be in gas, liquid, solid, or supercritical phase states. Matter of colloidal size, just above atomic dimensions and overlapping with the emerging regime of nanotechnology, exhibits physicochemical properties that differ from those of the constituent atoms or molecules yet are also different from macroscopic material.

The atoms and molecules of classical chemistry are extremely small, usually having molar masses of less than 1000 g/mol and measurable by freezing point depression. Macroscopic particles fall into the realm of classical physics and can be understood in terms of physical mechanics. Residing between these extremes is the colloidal size range of particles whose small sizes and high surface-area-to-volume ratios make the properties of their surfaces very important and lead to some unique physical properties. Their solutions may have undetectable freezing point depressions, and their dispersions, even if very dilute, may sediment out very slowly, in apparent violation of Stokes' law. Whereas the particles of classical chemistry may have one or a few electrical charges, colloidal particles may carry thousands of charges. With such strong electrical forces, complete dissociation is the rule for colloidal species, rather than the exception. In addition, the electric fields can strongly influence the actions of neighbouring species. The above definition of colloidal species encompasses not only particles, droplets and bubbles, but also thin films on large surfaces (e.g., antiglare coatings on glasses) and liquid films such as cosmetics on skin. Since for colloidal species the specific surface areas (surface area per unit mass) are relatively large, the properties of the interfaces can have an important influence on their properties. For this reason colloid and interface chemistry are usually treated as a single scientific discipline.

Systems containing colloidal-sized particles, droplets, or bubbles are important because they feature prominently, in both desirable and undesirable contexts, in a wide variety of practical disciplines, products, and industrial processes. The prob-

lems associated with colloids are usually interdisciplinary in nature and a broad scientific base is required to understand them completely.

The field began to acquire its own identity when Graham coined the term colloid in 1861 [6–8]. Since that time the language of colloid science has evolved considerably [9–11] and makes two principal distinctions: lyophobic (thermodynamically unstable) and lyophilic (thermodynamically stable) colloidal dispersions. If the dispersion medium is aqueous then the terms hydrophobic and hydrophilic, respectively, are used. Lyophilic colloids are formed spontaneously when the two phases are brought together because the dispersion is thermodynamically more stable than the original separated state. The term lyophilic is less frequently used in modern practice because many of the dispersions that were once thought of as lyophilic are now recognized as single-phase systems in which large molecules are dissolved. Lyophobic colloids are not formed spontaneously on contact of the phases because they are thermodynamically unstable compared with the separated states. These dispersions can be formed with mechanical energy input via some form of agitation such as that provided by a propeller-style mixer, a colloid mill, or an ultrasound generator. The resulting suspension may have considerable stability as a metastable dispersion. Examples of lyophobic colloidal dispersions are emulsions, foams and particle suspensions. Examples of lyophilic colloidal dispersions are surfactant micelles, protein solutions, and viruses.

*In modern practice the terms lyophilic and lyophobic (especially hydrophilic and hydrophobic) are often used to characterize surfaces, in addition to colloidal dispersions. This sometimes leads to confusing usage. For example, a clay dispersion in water could be classified as a lyophobic colloid with hydrophilic surfaces.*

Simple colloidal dispersions are two-phase systems, comprising a dispersed phase of small particles, droplets or bubbles, and a dispersion medium (or dispersing phase) surrounding them. Although the classical definition of colloidal species (droplets, bubbles, or particles) specifies sizes of between one nanometre and one micrometre, in dealing with practical applications the upper size limit is frequently extended to tens or even hundreds of micrometres. For example, the principles of colloid science can be usefully applied to emulsions whose droplets exceed the 1  $\mu\text{m}$  size limit by several orders of magnitude. At the other extreme, the field of nano-

**Table 1.1** Types of colloidal dispersion.

Dispersed phase	Dispersion medium	Name
Liquid	Gas	Liquid aerosol
Solid	Gas	Solid aerosol
Gas	Liquid	Foam
Liquid	Liquid	Emulsion
Solid	Liquid	Sol, suspension
Gas	Solid	Solid foam
Liquid	Solid	Solid emulsion
Solid	Solid	Solid suspension

technology is pushing the lower size limit for organized structures below 1 nm. To give some idea of the sizes involved here, the diameter of a human blood cell is about 7500 nm (7.5  $\mu\text{m}$ ), that of an individual haemoglobin molecule is about 2.8 nm, while that of an oxygen molecule is about 0.16 nm.

A variety of types of colloidal dispersions occur, as illustrated in Table 1.1. In practice, many colloidal dispersions are more complex, as discussed in the following sections, so these dispersions are characterized by the nature of the continuous phase and a primary dispersed phase, according to the designations in Table 1.1. One reason for the importance of colloidal systems is that they appear in a wide variety of practical disciplines, products and processes. Examples include control of filtration, breaking emulsions, fire extinguishing foams, froth flotation and fractionation, managing multiphase fluid flow, preparing foods, and formulating personal care products (see Table 1.2). Additional examples can be found in Tables 9.1, 10.1, 11.1, 12.1, 13.1, 13.3, 14.1, and 15.1. The colloidal involvement in a process may be desirable, as in the stabilizing of emulsions in mayonnaise preparation, of a foam for fire

**Table 1.2** Some occurrences of emulsions, foams, and suspensions.

Field	Foam	Emulsion	Suspension
Environment and meteorology	Polluted river foams, bubbles of air in oceans and rivers	Water/sewage treatment emulsions, oil spill mousse emulsions	Suspended particles in rain, ocean, lake and river water, glacial runoff
Foods	Champagne, soda and beer heads, whipped cream, meringue, ice cream	Milk, butter, creams, mayonnaise, cheese, sauces, cream liqueurs	Jellies, chocolate drinks, semi-frozen drinks, ice cream, vegetable shortening
Geology, agriculture, and soil science	Foam fumigant, insecticide and herbicide blankets, bubbles of volatiles in magma	Insecticides and herbicides, sulfidic melt in magma	Mud, quicksand, clay soil suspensions
Manufacturing and materials science	Foam fractionation, pulping brownstock foam, detergent foam, flotation de-inking froth	Polishes, asphalt (paving) emulsion, latex paint	Ink, gel, paints, pulp fibre suspensions
Biology and medicine	Vacuoles, insect excretions, contraceptive foam, gastrointestinal foam	Soluble vitamin and hormone products, biological cells, blood, vesicles	Liniment suspensions, proteins, viruses, polymer-encapsulated drugs
Petroleum production and mineral processing	Refinery foams, oil and bitumen flotation froth, fire-extinguishing foam, explosion suppressant foam, mineral flotation froths	Emulsion drilling and stimulation fluids, <i>in situ</i> reservoir emulsions, process emulsions, transportation emulsions	Drilling fluids, drill cuttings, mineral process slurries, industrial process tailings
Home and personal care products	Shampoo suds, shaving cream, contraceptive foam, bubble bath foam, hair-styling mousse	Hair and skin creams and lotions	Exfoliating scrubs, facial masks, lip balms

extinguishing, or of a fluidized bed (suspension) for heavy oil upgrading. It may also be undesirable, as in the tendency of very finely divided and highly charged particles to resist settling and filtration in water treatment plants.

**Example.** It may happen that an emulsion that is desirable in one part of the oil production process may be undesirable at the next stage. For example, in the oilfields, an *in situ* emulsion that is purposely created in a reservoir as part of an oil recovery process may change to a different, undesirable type of emulsion (water dispersed in oil) when produced at the wellhead. This emulsion may have to be broken and reformulated as a new emulsion suitable for transportation by pipeline to a refinery. Here, the new emulsion will have to be broken and water from the emulsion removed, which otherwise would cause processing problems in the refining process.

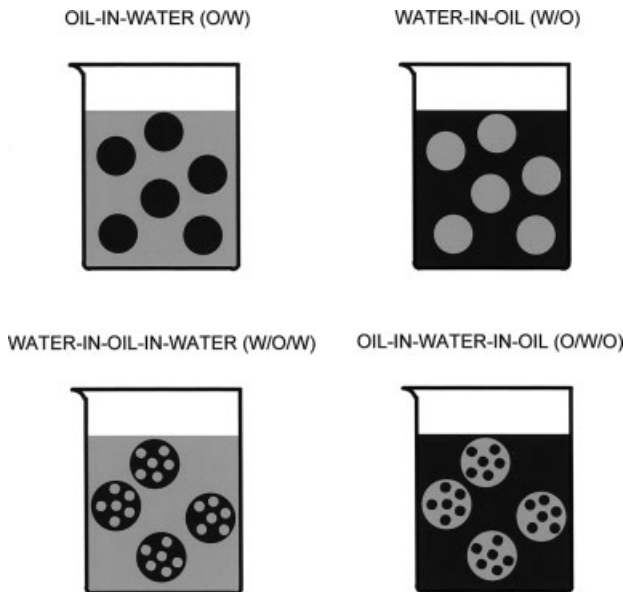
This book focuses on emulsions, foams, and suspensions; their fundamentals and applications. The variety of systems represented or suggested by Tables 1.1 and 1.2 underscores the fact that the problems associated with colloids are usually interdisciplinary in nature and that a broad scientific base is required to understand them completely. A wealth of literature exists on the topic of colloidal dispersions, including a range of basic colloid reference texts [12–28], dictionaries [9–11,29], and treatises on the myriad of applied aspects, of which only a few are cited here [1–5,30–36]. The widespread importance of emulsions, foams, and suspensions in particular, and scientific interest in their formation, stability and properties, have precipitated a wealth of specialized publications dedicated to each of emulsions [37–42], foams [43–47], and suspensions [48–51].

## 1.2 Classification of Emulsions, Foams, and Suspensions

### 1.2.1 Emulsions

Emulsions are colloidal dispersions in which a liquid is dispersed in a continuous liquid phase of different composition. The dispersed phase is sometimes referred to as the internal (disperse) phase and the continuous phase as the external phase. Practical emulsions may well contain droplets that exceed the classical size range limits given above, sometimes ranging upwards to tens or hundreds of micrometres. In most emulsions, one of the liquids is aqueous while the other is hydrocarbon and referred to as oil. Two types of emulsion are readily distinguished in principle, depending upon which kind of liquid forms the continuous phase (Figure 1.1):

- oil-in-water (O/W) for oil droplets dispersed in water
- water-in-oil (W/O) for water droplets dispersed in oil.



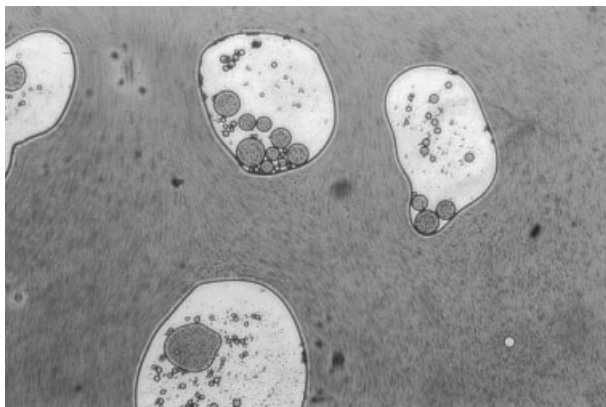
**Figure 1.1** (Upper) The two simplest kinds of emulsions, oil-in-water (O/W) and water-in-oil (W/O). (Lower) The next level of complexity, water-in-oil-in-water (W/O/W) and oil-in-water-in-oil (O/W/O). The droplet sizes have been greatly exaggerated.

Subsequent chapters provide many examples of emulsions in industry and everyday life. Solid emulsions and dispersions of liquid in a solid, are not, in general, covered in this book.

Practical situations are not always so simple and one may encounter double emulsions, that is, emulsions that are oil-in-water-in oil (O/W/O) and water-in-oil-in-water (W/O/W). For example, O/W/O denotes a double emulsion, containing oil droplets dispersed in aqueous droplets that are in turn dispersed in a continuous oil phase. The double emulsion droplets can be quite large (tens of  $\mu\text{m}$ ) and can contain many tens of droplets of the ultimate internal phase. Developments in and applications of double emulsions have been reviewed by Garti and Bisperink [52].

There can even be more complex emulsion types [2]; Figure 1.2 shows an example of a crude oil W/O/W/O emulsion. The type of emulsion that is formed depends upon a number of factors. If the ratio of phase volumes is very large or very small then the phase having the smaller volume is frequently the dispersed phase. If the ratio is closer to one then other factors determine the outcome. See Chapter 11 (especially Table 11.1) for examples of petroleum emulsion types.

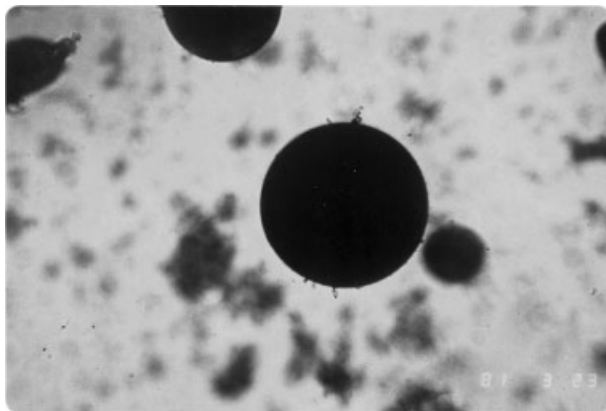
Most emulsions are not thermodynamically stable, but as a practical matter, quite stable emulsions can occur that resist demulsification treatments and may be stable for weeks/months/years. Most meta-stable emulsions that will be encountered in practice contain oil, water and an emulsifying agent (or stabilizer) which is usually a surfactant, a macromolecule, or finely divided solids. The emulsifier may be needed



**Figure 1.2** Example of a petroleum industry water-in-oil-in-water-in-oil (W/O/W/O) emulsion. From Schramm and Kutay [97]. Copyright 2000, Cambridge University Press.

to make the emulsion easier to form, or it may form a protective film, that helps keep the emulsion from breaking. The one kind of emulsion that is thermodynamically stable, microemulsion, is discussed in Section 3.8.

Emulsions may contain not just oil, water, and emulsifier (usually a surfactant), but also solid particles, and even gas. Figure 1.3 shows a practical O/W emulsion that contains suspended particles in addition to the oil drops. In the large Canadian oil sands mining and processing operations bitumen is separated from the sand matrix, in large tumblers, as an emulsion of oil dispersed in water, and then further separated from the tumbler slurry by a flotation process. The product of the flotation



**Figure 1.3** Photomicrograph of an emulsified droplet of a crude oil, dispersed in the aqueous solution that was used to release it from the mineral matrix in which it was originally held. Note the obvious presence of an interfacial film at the surface of the drop. Photomicrograph by the author.

process is bituminous froth, an emulsion that may be either water (and air) dispersed in the oil (primary flotation) or the reverse, oil (and air) dispersed in water (secondary flotation). In either case, the emulsions must be broken and the water removed before the bitumen can be upgraded to synthetic crude oil, but the presence of solid particles and film-forming components from the bitumen can make this very difficult. See Section 11.3.2.

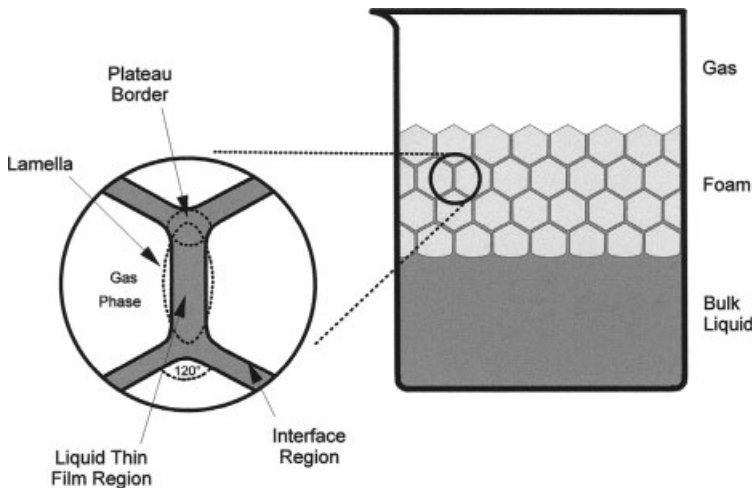
### 1.2.2

#### Foams

A foam is a colloidal dispersion in which a gas is dispersed in a continuous liquid phase. The dispersed phase is sometimes referred to as the internal (disperse) phase, and the continuous phase as the external phase. Despite the fact that the bubbles in persistent foams are polyhedral and not spherical, it is nevertheless conventional to refer to the “diameters” of gas bubbles in foams as if they were spherical. In practical occurrences of foams, the bubble sizes usually exceed the classical size limit given above, as may the thin liquid film thicknesses. In fact, foam bubbles usually have diameters greater than  $10\ \mu\text{m}$  and may be larger than  $1000\ \mu\text{m}$ . Foam stability is not necessarily a function of drop size, although there may be an optimum size for an individual foam type. It is common but almost always inappropriate to characterize a foam in terms of a given bubble size since there is inevitably a size distribution. This is usually represented by a histogram of sizes, or, if there are sufficient data, a distribution function.

Subsequent chapters provide many examples of foams in industry and everyday life. Solid foams, dispersions of gas in a solid, are not, in general, covered in this book.

A two-dimensional slice of a general foam system is depicted in Figure 1.4. The general foam structure is contained by the bulk liquid on the bottom and on the



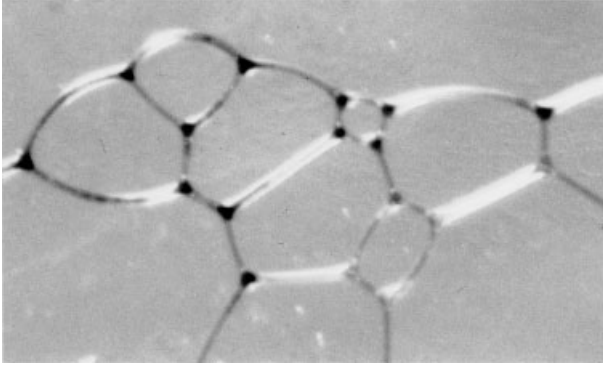
**Figure 1.4** Illustration of a generalized foam system showing aspects of a foam lamella.



upper side by a second bulk phase, in this case gas. In a persistent foam the bubbles are not spherical but have become transformed into foam cells, polyhedra separated by almost flat liquid films. Such foams are referred to as dry foams, or *Polyederschäum*. The polyhedra are almost, but not quite, regular dodecahedra. Within the magnified region of Figure 1.4 the various parts of the foam structure are clarified. The gas phase is separated from the thin liquid film, by a two-dimensional interface. In reality is not a sharp dividing surface between the gas and liquid properties. Dictated by mathematical convenience, the physical behaviour of this interfacial region is approximated by a two-dimensional surface phase (the Gibbs surface). For the purposes of this book, a lamella is defined as the region which encompasses the thin film, the two interfaces on either side of the thin film, and part of the junction to other lamellae.

The arrangement of films coming together at equal angles of  $120^\circ$  (called the Steiner angle) results from the equalization of the surface tension vectors, or contracting forces, along the liquid films. The bubbles in a foam arrange themselves into polyhedra such that, along the border of a lamella, three lamellae always come together at angles of  $120^\circ$ ; the border where they meet is termed a Plateau border. In three dimensions, four lamellae meet at a point at the tetrahedral angle, approximately  $109^\circ$ . Observations of dynamic foams show that whenever more films happen to come together, a rearrangement immediately takes place to restore junctions of only three films at Plateau borders in two dimensions, four lamellae in three dimensions. The three-dimensional foam bubbles are spherical in wet foams (i.e., those with gas volume fractions of up to  $\phi=0.74$ , the maximum volume fraction possible for an internal phase made up of uniform, incompressible spheres), but the foam bubbles start to distort in drier foams, in the range  $0.74 < \phi < 0.83$  (approximately). In still drier foams the foam cells take on a variety of polyhedral shapes ( $\phi > 0.83$ , approximately). There are many polyhedrons that can exist in foams and froths. One of the model shapes that may be the most stable, in terms of minimizing surface free energy, is the Kelvin tetrakaidecahedron, which has eight non-planar hexagon faces and six planar quadrilateral faces [53]. It should be remembered, however, that most foams contain a distribution of shapes (and sizes) [54].

Foams may contain not just gas and liquid (and usually surfactant), but also dispersed oil droplets and/or solid particles. Figure 1.5 shows a practical aqueous foam that contains dispersed oil droplets within the foam lamellae. This can occur, for example, when a foaming solution is used for detergent action in a cleaning process (see Section 12.2) or when a foam is propagated through an underground oil reservoir as part of an enhanced oil recovery process (See Section 11.2.2).



**Figure 1.5** Example of a petroleum industry foam containing emulsified crude oil droplets. Photomicrograph by the author.

### 1.2.3

#### **Suspensions**

A suspension is a colloidal dispersion in which a solid is dispersed in a continuous liquid phase (Figure 1.6). The dispersed solid phase is sometimes referred to as the internal (disperse) phase and the continuous phase as the external phase. Suspensions may be either aqueous or non-aqueous.

The classical size range for colloidal dispersions given above (1 nm – 1  $\mu\text{m}$ ) assumes dispersed species have a spherical shape. When other shapes are considered, particles with diameters of up to 2  $\mu\text{m}$  can be well described as colloids. Practical suspensions usually have diameters greater than 0.2  $\mu\text{m}$  and often contain particles that exceed the classical size range limits given above, sometimes to 50–100  $\mu\text{m}$  in diameter. The principles of colloid science are still important to the behaviour of

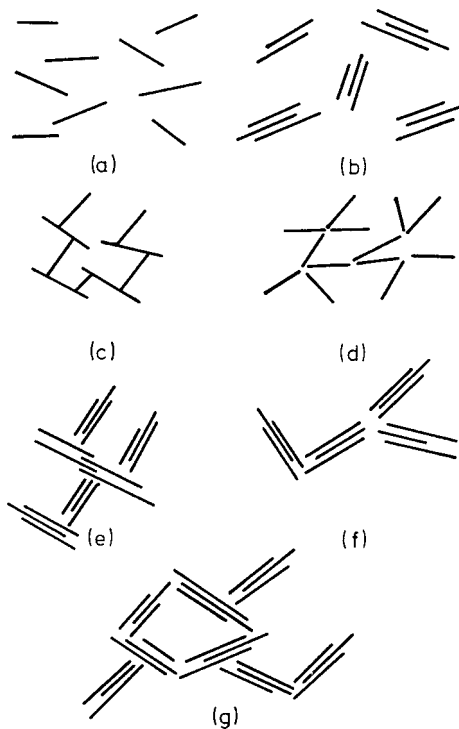


**Figure 1.6** Suspension of amber particles. Photomicrograph by the author.

such larger particles. The particle sizes can also fall below the classical size limit given above. Nanoparticle suspensions are increasingly being developed on the one hand. In some literature, the term “sol” is used to distinguish suspensions in which the particles are of such very small sizes.

In addition, clay particles can exhibit widely contrasting particle dimensions: their ratio of particle diameter to thickness can range from 10:1, to 250:1, depending upon the nature of the clay and its exchangeable ions [49]. Particles, which are frequently irregular in shape, are somewhat unique in the variety of associations that can take place in their dispersion. Figure 1.7 shows some of the modes of association among suspended clay mineral particles [55].

A suspension of particles in turbulent gas or liquid, or a mixture of both, behaves much like a fluid, hence the terms fluidization and fluidized beds. In the fluidized state, much larger particles can be maintained in suspension than would be possible under static or laminar flow conditions. This provides a means, for example, to make large particles flow like a fluid. The minimum fluidization velocity is the velocity of gas or liquid that is just needed to support the weight of the particles. At



**Figure 1.7** Modes of platelet associations in clay suspensions, (a) dispersed, (b) FF aggregated, (c) EF flocculated and dispersed, (d) EE flocculated and dispersed, (e) EF flocculated and aggregated, (f) EE flocculated and aggregated, (g) EF and EE flocculated and aggregated. From Schramm [55]. Copyright 1980, Laurier L. Schramm.

greater velocities, the particles are transported. When the fluidized bed is maintained by the flow of gas bubbles, there is also a critical, minimum bubble size. The principal difference between fluidized beds maintained by liquid and gas flow is that the former, being stabilized by an integral continuous phase, are homogeneous. The latter, being stabilized by bubbles, rather than a continuous phase, are not homogeneous. There are also differences in density contrast between the phases, and there can be differences in electrical charging. Fluidized beds involving solid particles have been used where efficient mixing, heat transfer, and/or mass transfer are needed [56]. Examples include fluidized beds of catalyst particles, of coal particles for combustion, and in deep-bed filtration for water treatment. Where the particles are less dense than the fluid, then the bed is fluidized by causing the continuous phase to flow downwards rather than upwards. This has been termed inverse fluidization [56].

Subsequent chapters provide many examples of suspensions in industry and everyday life. Solid suspensions and dispersions of one solid in another solid, are not, in general, covered in this book.

Just as with emulsions and foams, suspensions can exist with additional dispersed phases present. They may contain, in addition to solid particles and a continuous liquid phase (and possibly a stabilizing agent), emulsified droplets and/or gas bubbles. Figure 2.4 (in Section 2.2.1) shows photomicrographs of a practical suspension that contains suspended oil droplets in addition to the particles. The terminology used to describe such systems can become confusing. Consider an aqueous dispersion of solid particles and emulsion droplets. If the solid particles are adsorbed on the emulsion droplets then it is an emulsion that also contains solids. If, however, the particles and droplets are not mutually associated then the system is at once a suspension and an emulsion. Which term is used becomes a matter of choosing the most appropriate context; frequently one or the other is considered to be the primary dispersion while the other phase is considered to be an additive or a contaminant.

### 1.3

#### **Characterization and Stability**

For lyophobic dispersions, which are not thermodynamically stable, the degree of kinetic stability is very important (see Section 5.5). A complete characterization of colloid stability requires consideration of the different processes through which dispersed species can encounter each other: sedimentation (creaming), aggregation, and coalescence. Sedimentation results from a density difference between the dispersed and continuous phases and produces two separate layers of dispersion that have different dispersed phase concentrations. One of the layers will contain an enhanced concentration of dispersed phase, which may promote aggregation. Aggregation is when any of Brownian motion, sedimentation, or stirring cause two or more dispersed species to clump together, possibly touching at some points, and with virtually no change in the total surface area. In aggregation the species retain

their identity but lose their kinetic independence since the aggregate moves as a single unit. Aggregation of droplets may lead to coalescence and the formation of larger droplets until the phases become separated. In coalescence thin film drainage occurs, leading to rupture of the separating film, and two or more particles, droplets or bubbles fuse together to form a single larger unit, reducing the total surface area. In this case the original species lose their identity and become part of a new species. Kinetic stability can thus have different meanings. A colloidal dispersion can be kinetically stable with respect to coalescence, but unstable with respect to aggregation. Or, a system could be kinetically stable with respect to aggregation but unstable with respect to sedimentation. In summary, although lyophobic colloids are thermodynamically unstable, they may be relatively stable in a kinetic sense, and it is crucial that stability be understood in terms of a clearly defined process.

The next four chapters provide an introduction to the concepts and techniques needed to study and understand dispersion stability. Some approaches to the characterization of emulsions, foams and suspensions, and of their dispersed species (droplets, bubbles and particles) are described in Chapter 2. The concepts of surface tension, wettability and surface activity, which are important to the stability and properties of all types of dispersion, are described in Chapter 3. To this is added the nature of electrically charged surfaces in Chapter 4. All of these aspects are brought together in Chapter 5 in an introduction to the stability of dispersions.

## 2

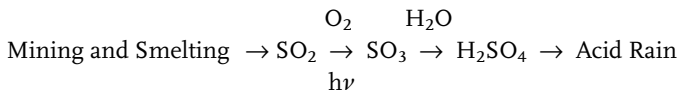
### Dispersion and Dispersed Species Characterization

The characterization of colloids depends on the purposes for which the information is sought, because the total description would be an enormous task. Among the properties to be considered are the nature and/or distributions of purity, crystallinity, defects, size, shape, surface area, pores, adsorbed surface films, internal and surface stresses, stability, and state of agglomeration [57,58].

#### 2.1

##### Surface Area, Porosity, and Permeability

Some very interesting and important phenomena involve small particles and their surfaces. For example,  $\text{SO}_2$  produced from mining and smelting operations that extract metals such as Cu and Pb from heavy metal sulfide ores, can be oxidized to  $\text{SO}_3$  in the atmosphere, thus contributing to acid rain problems.



Here the reaction rate depends not only on the concentration of the  $\text{SO}_2$  but also on the surface area of any catalyst available, such as airborne dust particles. The efficiency of a catalyst depends upon its specific surface area,  $A_{\text{sp}}$ , defined as the ratio of surface area to mass [30]. Accordingly, this property is frequently used as a basis for comparing different kinds of catalysts, or catalyst supports, and for diagnosing practical problems in catalysts being used in a process (since both agglomeration and poisoning reduce  $A_{\text{sp}}$ ). The specific surface area of the airborne dust particles, considering  $n$  spheres of density  $\rho$  and radius  $R$ , would be:

$$A_{\text{sp}} = \frac{(\# \text{ particles})(\text{area/particle})}{(\# \text{ particles})(\text{mass/particle})} = \frac{n4\pi R^2}{\{n(4/3)\pi R^3 \rho\}} = \frac{3}{\rho R} \quad (2.1)$$

**Example.** Consider two 1 g samples of silica spheres, in one sample the spheres are 1mm diameter, in the other they are 1  $\mu\text{m}$  diameter. The total mass of each is the same (density 2  $\text{g}/\text{cm}^3$ ), do they also have the same amount of surface area ?

$$\begin{array}{ll} \text{Sample 1:} & \text{Sample 2:} \\ R = 0.1 \text{ cm} / 2 & R = 1.0 \times 10^{-4} \text{ cm} / 2 \\ A_{\text{sp}} = 30 \text{ cm}^2/\text{g} & A_{\text{sp}} = 3.0 \times 10^4 \text{ cm}^2/\text{g} \\ = 0.0030 \text{ m}^2/\text{g} & = 3.0 \text{ m}^2/\text{g} \end{array}$$

The sample of smaller particles has 1000 times more surface area. If they were airborne dust particles, with other factors being equal, the higher surface area sample would much more efficiently catalyze the  $\text{SO}_2 \rightarrow \text{SO}_3$  reaction.

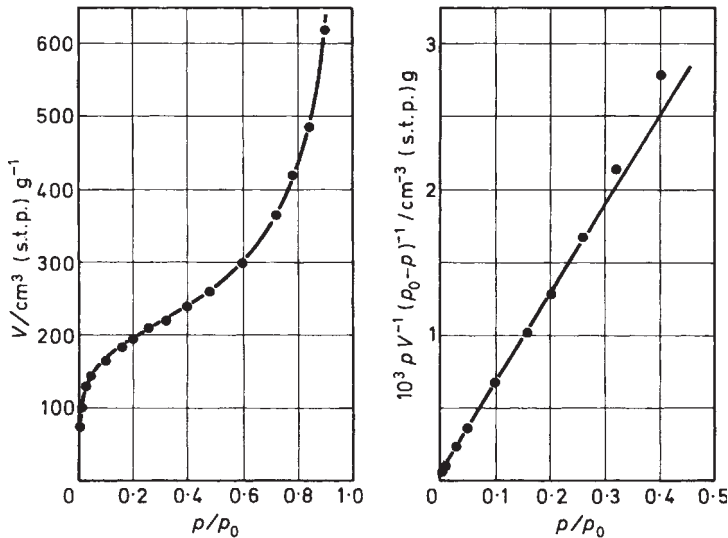
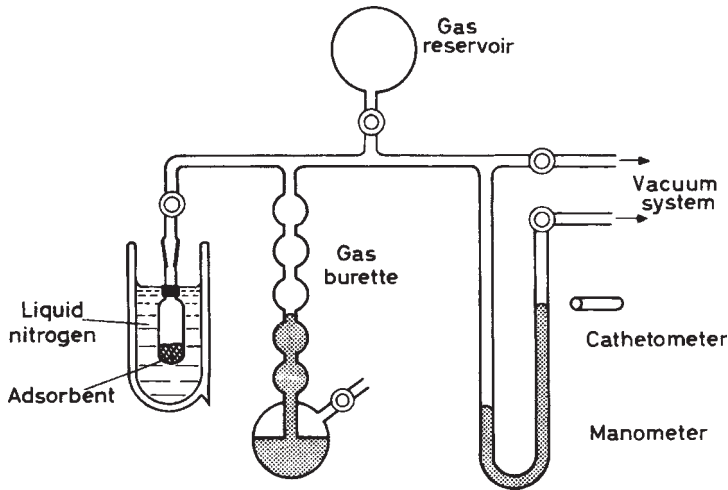
The specific surface area depends on both the size and shape and is distinctively high for colloidal-sized species. This is important in the catalytic processes used in many industries for which the rates of reactions occurring at the catalyst surface depend not only on the concentrations of the feed stream reactants, but also on the surface area of catalyst available. Since practical catalysts are frequently supported catalysts, some of the surface area is more important than the rest. Also, given that the supporting phase is usually porous, the size and shapes of the pores may influence the reaction rates as well. The final rate expressions for a catalytic process may contain all of these factors: surface area, porosity, and permeability.

The total surface area can be estimated by measuring the amount of gas needed to form an adsorbed monolayer by physical adsorption [50,59], in which case the number of molecules adsorbed divided by the area per molecule, yields the surface area. An adsorption isotherm is the relationship between the equilibrium amount of gas adsorbed and the gas pressure, all at some constant temperature. A known mass of sample is placed in a sample tube under vacuum. The connecting apparatus is capable of delivering known volumes of gas and measuring the pressures. A simple apparatus and some typical results are shown in Figure 2.1 [60]. To get enough physical adsorption of gas, a low temperature has to be used, typically nitrogen gas at 77 K (i.e., liquid nitrogen temperature). More details can be found in Refs. [13,15,61].

The classic models for physical adsorption are those of Langmuir and of Brunauer, Emmett and Teller. Langmuir proposed a model of gas adsorption involving monomolecular adsorption and constant  $\Delta H_{\text{ads}}$ , independent of the extent of surface coverage:

$$P/V = P/V_m + 1/(aV_m) \quad (2.2)$$

where  $V_m$  = volume of gas needed for monolayer  
 $a$  = constant for given temperature  
 $V$  = equilibrium volume of gas adsorption per unit mass of adsorbent



**Figure 2.1** An apparatus for measuring gas adsorption (upper) and some typical results (lower) for the multilayer adsorption of nitrogen on a non-porous sample of silica gel at 77K. From Shaw [60]. Copyright 1966, Butterworths.

A plot of  $P/V$  versus  $P$  should then yield a straight line whose slope and intercept can be used to calculate  $V_m$  and  $a$ .  $A_{sp}$  can then be calculated from  $V_m$  using the area per molecule for adsorbed gas, usually assuming close-packed spheres. The



major problems with this model are that monomolecular adsorption and constant  $\Delta H_{\text{ads}}$  are frequently not very good assumptions.

Brunauer, Emmett, and Teller (BET) proposed a model that extends the Langmuir model to multilayer adsorption and which has several  $\Delta H_{\text{ads}}$  components. The BET equation treats the extra adsorption layers by analogy with evaporation and condensation processes, and takes the form:

$$P / \{V(P_0 - P)\} = 1/(V_m c) + (c-1)P / (V_m c P_0) \quad (2.3)$$

where  $P_0$  = saturation vapour pressure

$$c \approx (\Delta H_L - \Delta H_1)/RT$$

$\Delta H_L$ : liquefaction of extra layers

$\Delta H_1$ : monolayer adsorption

A plot of  $P/[V(P_0 - P)]$  versus  $P/P_0$  should give a straight line from which the slope and intercept can be solved to yield  $V_m$ . From  $V_m$  the specific surface area can be calculated if it is known how much area each molecule occupies on the surface,  $a_m$ . For nitrogen gas,  $a_m = 16.2 \times 10^{-20} \text{ m}^2$ , based on the liquid nitrogen density of 0.81 g/mL, and assuming a close-packed sphere arrangement. In this case the total surface area per gram,  $A_{\text{sp}} = V_m N_A a_m \rho / \text{MW}$ , where  $N_A$  = Avogadro's number,  $a_m = N_2$  area/molecule,  $\rho = N_2$  density and  $\text{MW} = N_2$  molecular mass.

The foregoing represent the classic models for physical adsorption, that of Langmuir (monomolecular adsorption and constant  $\Delta H_{\text{ads}}$ , independent of the extent of surface coverage) and BET (multilayer adsorption and several  $\Delta H_{\text{ads}}$  components). Many other models are available as well [13,15,30]. These models require a knowledge of the area which each molecule occupies on the surface.

Chemisorption can be studied in the same fashion as described for nitrogen adsorption but using a gas that is chemisorbed, i.e., that bonds chemically. For example, hydrogen might be made to bond to metal surfaces. In addition to  $V_m$  one needs the number of surface metal atoms associated with each gas molecule ( $X_m$ ), plus the number of metal atoms per unit surface area ( $n_s$ ):

$$A_{\text{ch}} = (V_m N_A X_m \rho) / (\text{MW } n_s) \quad (2.4)$$

Using  $n_s$ , obtained from surface crystallography, one can obtain  $X_m$ . This yields a specific chemisorption surface area.

In evaluating particles from a suspension, such as a fluidized bed of supported catalyst, both kinds of surface area may need to be measured. Particle size changes would be reflected in the specific surface area,  $A_{\text{sp}}$ . Site deactivation, such as when metal sites are deactivated due to being covered by a poison, might not cause any change in  $A_{\text{sp}}$ , but there would be a reduction in  $A_{\text{ch}}$ .

The Langmuir and BET equations work well with non-porous solids, but not as well for porous solids because the pores influence the local numbers of adsorption layers formed. Nevertheless, by using adsorption gases of different molecular size or by varying the temperature, pores of different size will be accessible to the adsorbing

molecule. Coupling this with the appropriate mathematical interpretation allows for the determination of solid porosity using BET analysis. The porosity is given by  $\phi$ :

$$\phi = V_p / V_b \quad (2.5)$$

Where  $V_p$  is the pore volume and  $V_b$  is the bulk volume of the sample.

The porosity of a solid is most easily determined by the imbibition method. A sample of solid is dried, weighed while dry, then saturated with a wetting liquid (such as water or heptane), under vacuum. The accessible pore volume is calculated by a material balance:

$$V_p = (M' - M) / \rho \quad (2.6)$$

where  $M$  and  $M'$  are the dry and saturated masses respectively. The bulk volume,  $V_b$ , is measured independently. This yields the overall porosity of the sample, but it doesn't reveal any information about the actual pores.

In prepared catalysts the pore sizes may be quite uniform. However, in most naturally occurring materials there is a wide range of pore sizes. The actual pore size distribution can be obtained from methods such as porosimetry, in which a non-wetting liquid (usually mercury) is pumped into a solid sample [12,13,15,26,30,55]. The solid is considered to be composed of a bundle of capillaries. For each capillary, the Laplace equation (see Section 3.2.2) gives the pressure drop across a curved liquid surface:

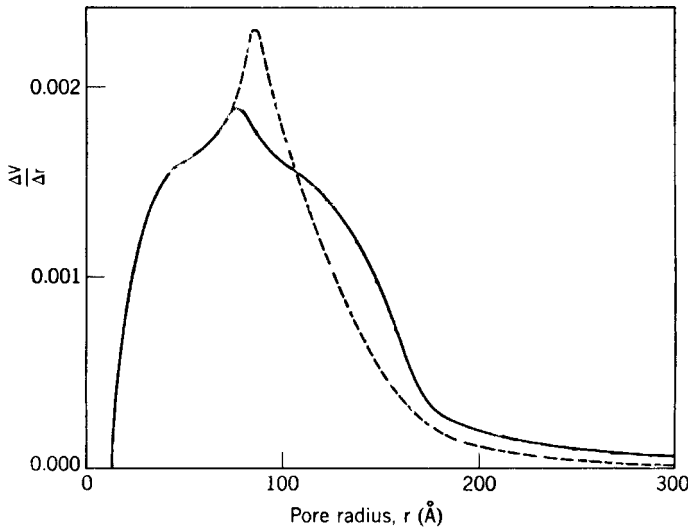
$$\Delta P = \gamma (1/R_1 + 1/R_2) \quad (2.7)$$

where  $\gamma$  is the surface tension and  $R_1$  and  $R_2$  are the principal radii of curvature. For a circular interface,  $\Delta P = 2\gamma/R$ . This holds where the contact angle (see Section 3.4) is either  $\theta = 0$  or  $180^\circ$ , that is, for a completely wetting or non-wetting liquid, respectively. A more general equation is  $\Delta P = 2\gamma \cos\theta / R$ . In mercury porosimetry, mercury is used as a non-wetting liquid ( $\theta = 140^\circ$  on glass) and is pumped into a solid sample. For each increment of applied pressure, only pores of  $R > 2\gamma |\cos\theta| / \Delta P$  will be filled. So each increment of  $\Delta P$  causes somewhat smaller pores to be filled. Employing a series of pressure increments allows the pore size distribution to be obtained. If  $dV$  is the volume of pores from  $r$  to  $r - dr$ , then  $dV = D(r) dr$  where  $D(r)$  is the distribution function of pore radii  $r$ . Using the Laplace equation, it can be shown that

$$D(r) = (\Delta P/r) (dV/d\Delta P) \quad (2.8)$$

$D(r)$  is obtained from the slopes of a plot of  $V$  versus  $\Delta P$ . An example is shown in Figure 2.2.

The ease with which a fluid can flow through a porous medium, permeability, can be determined through the measurement of pressure drop ( $\Delta p$ ) across the porous medium under steady flow. The intrinsic permeability ( $k$ ) is defined by Darcy's law and is given by  $k = (Q/A)(\eta L/\Delta p)$  where  $Q$  is the discharge flow rate,  $A$  is the



**Figure 2.2** Illustration of pore volume distribution curves for charcoal as obtained from a nitrogen adsorption isotherm (solid curve) and from a mercury porosimeter (broken curve). From data in Adamson [15].

cross-sectional area normal to the main flow direction,  $\eta$  is the flowing fluid viscosity,  $L$  is the length of the flow path (sample), and  $\Delta p$  is the pressure gradient along the medium [4]. Mercury porosimetry can also be used to assess permeability [30,52,62].

## 2.2 Size and Size Distribution

As noted previously, the dispersed species in many practical emulsions, foams, and suspensions can be greater than the classical colloid dispersion range of between  $10^{-3} \mu\text{m}$  and  $1 \mu\text{m}$  in diameter. Emulsion droplets (e.g., the fat droplets in milk) are often larger, usually have diameters greater than  $0.2 \mu\text{m}$ , and may have diameters larger than  $50 \mu\text{m}$ . Foam bubbles are almost always larger (e.g., the bubbles in dish washing suds); usually with diameters greater than  $10 \mu\text{m}$  and sometimes larger than  $1000 \mu\text{m}$ . Suspension particles usually have diameters greater than  $0.2 \mu\text{m}$  and may be larger than  $50 \mu\text{m}$ . The simplest characterization is in terms of an average size, but even here one has to be careful of what is being averaged since size-dispersed species sizes may be averaged in terms of a number average, surface average, or volume average, among others.

With regard to the concept of average size, it is important to note that, although very common, it is generally inappropriate to characterize a dispersion in terms of a given droplet, bubble, or particle size. This is because there is inevitably a size distribution. That is, most dispersions are polydisperse. Even if they are initially monodis-

perse, nearly all colloidal systems undergo some aggregation leading to a distribution of aggregate sizes. The distribution is usually represented by a histogram of sizes, or, if there are sufficient data, a distribution function.

Dispersion stability is not necessarily a function of dispersed species size, although there may be an optimum size for an individual dispersion type. In some dispersions having a distribution of sizes that is heavily weighted towards the smaller sizes will represent the most stable dispersion. In such cases, changes in the size distribution curve with time, yield a measure of the stability of the dispersions. The size distribution also has an important influence on the viscosity. For electrostatically or sterically interacting species, the dispersion viscosity will be higher, for a given mass or volume concentration, when the species are smaller. For example, when there are electrostatically or sterically interacting bubbles in a foam, the viscosity will be higher when bubbles are smaller (for a given foam quality defined by its gas volume) because the increased interfacial area and thinner films increase the resistance to flow. The viscosity of all dispersions will tend to be higher when the dispersed species sizes are relatively homogeneous, that is, when the particle size distribution is narrow rather than wide [37].

Dispersed species are not always as conveniently spherical as shown in Figure 1.3, although they may have a high degree of symmetry and can sometimes be approximated as spheres. Examples include polyhedral species such as particles of carbon black or gas cells in a concentrated foam. Several parameters are used in the description of shape, including the Martin diameter (in direct imaging) and the equivalent spherical diameter (in sedimentation). The Martin diameter is the length of a line that bisects the projected area of a particle. In determining Martin diameters the direction in which the line is drawn is arbitrary, but should be chosen consistently. An example is given by Hiemenz and Rajagopalan [13]. Less symmetric species are sometimes characterized as oblate ellipsoids or by fractals. For oblate ellipsoids one measures a distance  $a$  as the radius along the axis of rotation and a distance  $b$  as a radius in the equatorial plane. The departure of the shape from spherical is then described by the ratio  $a/b$  (for a sphere  $a/b=1$ ). An application of this concept can be found in the Simha Equation (see Section 6.5.1 and Eq. (6.37)). Additional details are given in [13,26].

There are many methods for the determination of the size distribution of dispersed species. Table 2.1 shows some of the size ranges covered. Some of the principal methods are discussed in the following sections.

**Table 2.1** Classification of some size methods.

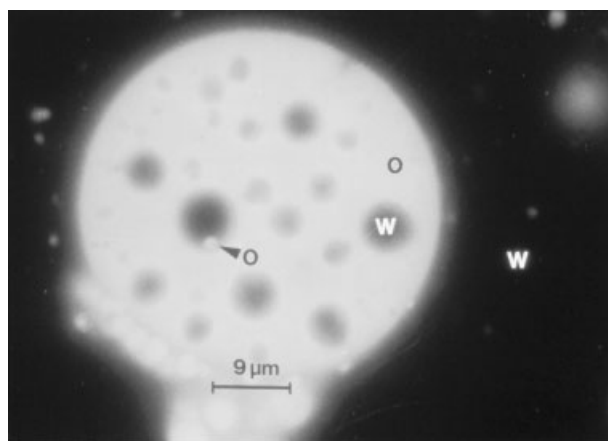
Method	Approximate size range ( $\mu\text{m}$ )		Capability of technique	
	Lower	Upper	Mean diameter	Distribution
Sieves	$5 \times 10^0$	$8 \times 10^4$	✓	✓
Impingers	$1 \times 10^{-1}$	$5 \times 10^0$	✓	✓
Ultramicroscope	$5 \times 10^{-3}$	$5 \times 10^{-1}$	✓	X
Microscope	$5 \times 10^{-1}$	$5 \times 10^2$	✓	✓
Electron microscope	$1 \times 10^{-3}$	$2 \times 10^1$	✓	✓
Elutriation	$3 \times 10^0$	$2 \times 10^2$	✓	✓
Centrifuge	$5 \times 10^{-2}$	$3 \times 10^0$	✓	✓
Sedimentation	$1 \times 10^0$	$2 \times 10^2$	✓	✓
Ultracentrifuge	$1 \times 10^{-3}$	$1 \times 10^0$	✓	✓
Turbidimetry	$1 \times 10^{-2}$	$5 \times 10^1$	✓	✓
Light scattering	$1 \times 10^{-2}$	$1 \times 10^1$	✓	✓
Neutron scattering	$4 \times 10^{-4}$	$1 \times 10^{-2}$	✓	✓
X-ray diffraction	$2 \times 10^{-3}$	$1 \times 10^{-1}$	✓	X
Permeability	$1 \times 10^{-1}$	$5 \times 10^1$	✓	X
Micrometers/calipers*	$5 \times 10^1$	$>2 \times 10^4$	✓	✓

\* Visible to human eye.

### 2.2.1

#### Microscopy

If the sizes of particles, droplets, bubbles, or their aggregates in a dispersion are large enough, then optical microscopy can be used to determine the shape, size, and size distribution, but if they are smaller than about  $0.5 \mu\text{m}$  they will not be resolved

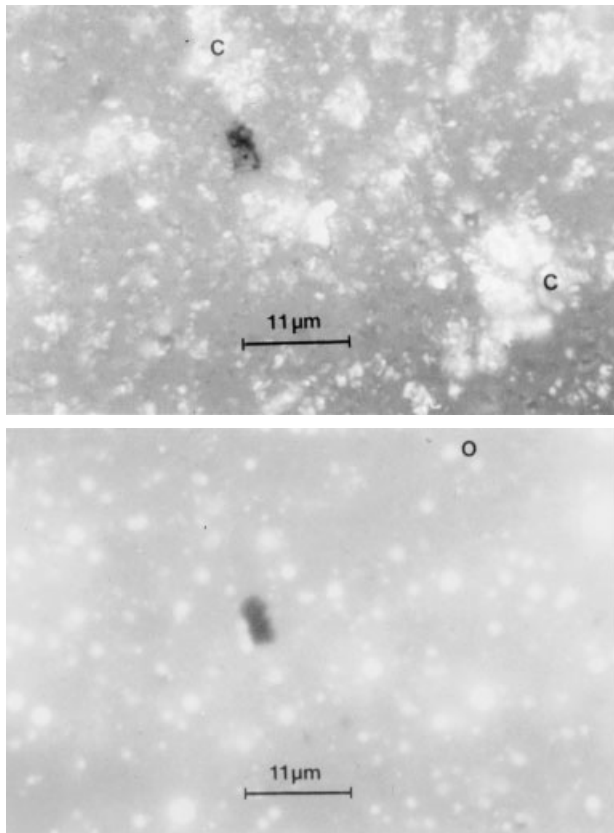


**Figure 2.3** Optical micrograph using reflected fluorescent light showing a multiple emulsion. The continuous water phase (W, dark) shows a large dispersed oil droplet (O, bright) that contains a water droplet that also contains emulsified oil. The arrow points out an oil-in-water in oil-in-water emulsion droplet. From Mikula [66].

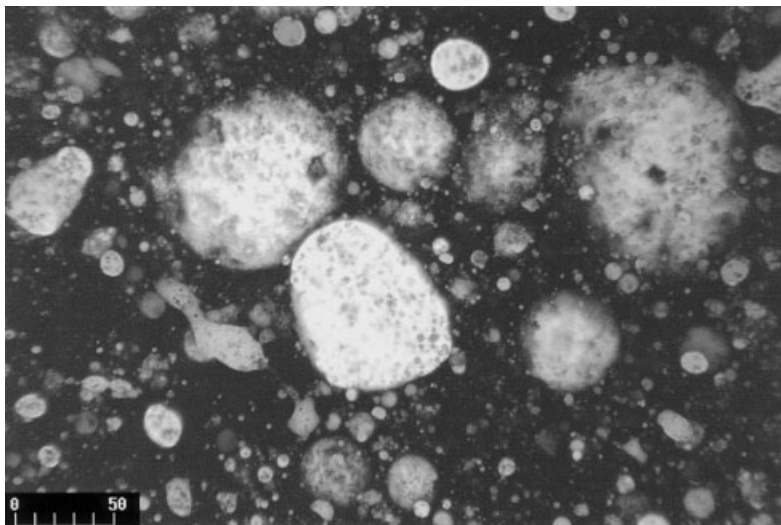
Copyright 1992, American Chemical Society.

in a typical optical microscope. Optical microscopy may involve any of transmitted, reflected, or polarized light, including fluorescence [63,64]. The application of microscopy to particle suspensions is fairly straightforward [65], but can be deceiving for emulsions and foams, which are subject to creaming, sedimentation, coalescence, and inversion. Mikula [66] describes some of the precautions and pitfalls involved in establishing a representative sample for microscopy.

Figure 2.3 shows an optical micrograph obtained with reflected fluorescent light. This technique clearly shows the presence of a multiple, O/W/O/W, emulsion which would have been extremely difficult to detect by other means. Combined techniques can be used to observe different dispersed species. For example, reflected white light can make dispersed particles easy to observe (Figure 2.4a) whereas reflected light on



**Figure 2.4** (Upper) White-light (polarized) photomicrograph, in reflected mode, of an suspension with a significant emulsified oil content. With polarized light, the clays (C) appear bright, but the oil droplets cannot be seen at all. (Lower) In this reflected-light photomicrograph, of the same field of view as above, the fluorescence mode shows bright oil droplets in a dark water-continuous phase. In this photograph the clays cannot be seen. From Mikula [66]. Copyright 1992, American Chemical Society.



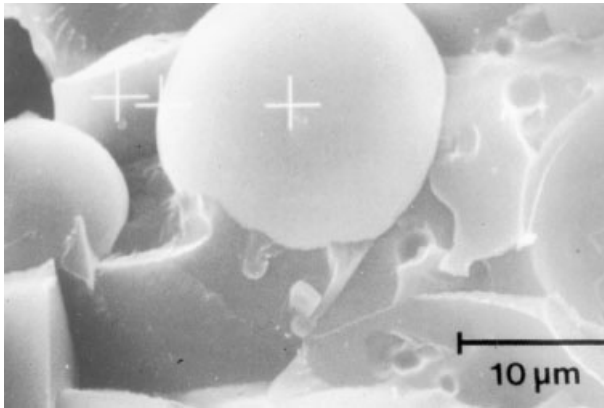
**Figure 2.5** An O/W emulsion showing a significant interaction between solids and the oil phase. A significant percentage of the solids are intruded into the oil droplets (the oil is bright, the water and solids are dark in this image). From Mikula and Munoz [68]. Copyright 2000, Cambridge University Press.

fluorescence mode can make oil droplets visible (Figure 2.4b), all using the same field of view in the same sample [66]. Figure 2.5 shows the close association of solids with the oil phase indicated by the large number of particles at the O/W interface.

Confocal laser scanning microscopy (CLSM) involves scanning a sample with a finely focused laser beam, and can extend the resolution of optical microscopy down to about  $0.1\ \mu\text{m}$  [67]. The reflected or fluoresced light is detected and digitized, with out-of-focus information being removed using an adjustable pinhole-iris filter placed before the detector. By scanning and digitizing images over a range of depths in a sample, it is possible to create digital reconstructions with dramatically increased depth of field, orders of magnitude better than can be achieved with an ordinary light microscope. This permits imaging of structures with height differences on the order of the wavelength of the light source, construction of profiles, three-dimensional images, and quantitative measurements of height. In addition, the CLSM technique can simultaneously acquire images in two wavelengths, such as causing fluorescence of some sample components at one wavelength, detecting the fluorescence image at another, and detecting reflected light from other components at a second wavelength. By merging the two digital images, one can study associations between fluorescing (usually organic components) and non-fluorescing (usually inorganic) components in a sample. Such images can provide information about the placement of, and associations between, dispersed species [66,68,69].

For dispersions of smaller species, down to  $0.1\ \mu\text{m}$ , or less, the most direct and accurate methods for size determination include scanning and transmission elec-

tron microscopy. Since electron microscopy usually involves exposing samples to a high vacuum, sample dispersions may need to be dried or otherwise treated (such as coating with carbon or a metal to create replicas). Nevertheless, some very useful results have been obtained for suspensions [1,69], emulsions [66], and foams [70]. For scanning electron microscopy, adaptations, such as wet “environmental” chambers or cryogenic-stages, can also be used. This is well documented for suspensions, but emulsions, microemulsions, and foams can also be characterized using cryogenic-stage scanning electron microscopy [66,68–73]. Figure 2.6 shows a micrograph obtained by cryogenic scanning electron microscopy for water droplets in a W/O emulsion.



**Figure 2.6** Electron micrograph of a water-in-oil emulsion by fast freezing and direct observation on a cryogenic stage. From Mikula [66]. Copyright 1992, American Chemical Society.

### 2.2.2

#### **Sieving**

If the particles in a suspension are larger than approximately  $5\ \mu\text{m}$  the particle-size distribution can be evaluated using sieving [57,58,69,74]. Sieve pans are constructed using micromesh, woven wires, punched plates, or photo-etching in order to provide specific sized openings. Sieve tests are conducted by (usually) mechanically shaking stacks of sieve pans having larger openings at the top and finer openings at the bottom. Depending upon the circumstances, sieving may be conducted wet or dry. The test can be influenced by several complicating variables, including the method of shaking, sieve loading, the actual particle size and shape distribution in a given sample, and any tendency for the particles to aggregate. A number of sieve standards remain in use, including those set by Tyler, the American Society for Testing and Materials (ASTM), and the International Standards Organization (ISO) [69].



## 2.2.3

**Radiation Scattering**

Small, dispersed particles or droplets cause the “cloudy” or “milky” appearance of such diverse colloids as dust clouds, rain clouds, suspended sediment in a river, and milk. This appearance is due to light scattering. When a beam of light enters a colloidal dispersion some light is absorbed, some is scattered, and some is transmitted. The intensity of the scattered light depends largely on the size and shape of the colloidal species, and on the difference in refractive index between the phases. If there is no refractive index difference then there is no scattering. The intensity of scattered light can often be detected by the eye, and in a suitable instrument it can be measured directly. Light-scattering analysis is a very powerful tool because it can yield the complete dispersed phase-size distribution.

If the dispersed phase concentration is not too high, and the species are very small, light-scattering can yield size information. The theory underlying the determination of size distribution for a colloidal dispersion is quite involved [13,75,76]. When a beam of light enters a suspension some light is absorbed, some is scattered, and some is transmitted. Many dilute, fine emulsions and suspensions show a noticeable turbidity given by,

$$I_t/I_0 = \exp(-\tau l) \quad (2.9)$$

where  $I_t$  is the intensity of the transmitted beam,  $I_0$  the intensity of the incident beam,  $\tau$  the turbidity, and  $l$  is the path length through the sample.

From Rayleigh theory, the intensity of light scattered from each droplet or particle depends largely on its size and shape, and on the difference in refractive index between the particle and the medium. For a dispersion, each spherical droplet, bubble, or particle scatters unpolarized light having an intensity  $I_d$  at a distance  $x$  from the particle, according to the following relationship:

$$I_d/I_0 \propto r^6/x^2\lambda^4 \quad (2.10)$$

where  $\lambda$  is the wavelength of the light and  $r$  is the droplet or particle radius. This applies to dispersed species that are smaller than the wavelength of the light. Turbidity measurements can be used to obtain an estimate of only the average particle or droplet size, not a distribution, and the apparent average tends to be skewed somewhat towards the larger-sized species (which scatter more light).

Aqueous suspensions may exhibit different colours due to their scattering of light. A suspension of very fine gold particles (ca. 60 nm) appears red while a suspension of only slightly larger particles (ca. 120 nm) appears blue. A coarse dispersion (large-sized dispersed species) may appear opaque and white. However, not all dispersions exhibit the opaqueness with which they are usually associated. A dispersion can appear transparent if the dispersed species are sufficiently small compared with the wavelength of the illuminating light. If the droplets, bubbles, or particles have diameters of less than 50 nm or so, the dispersion will appear to be transpar-

ent. If the diameters are of the order of 15 nm, even a 30% dispersion will appear to be clear. However, if the size of the dispersed species increases to about 1  $\mu\text{m}$  diameter, a dilute dispersion will take on a somewhat milky-blue cast. If the species are very much larger, then the dispersed phase will become quite distinguishable.

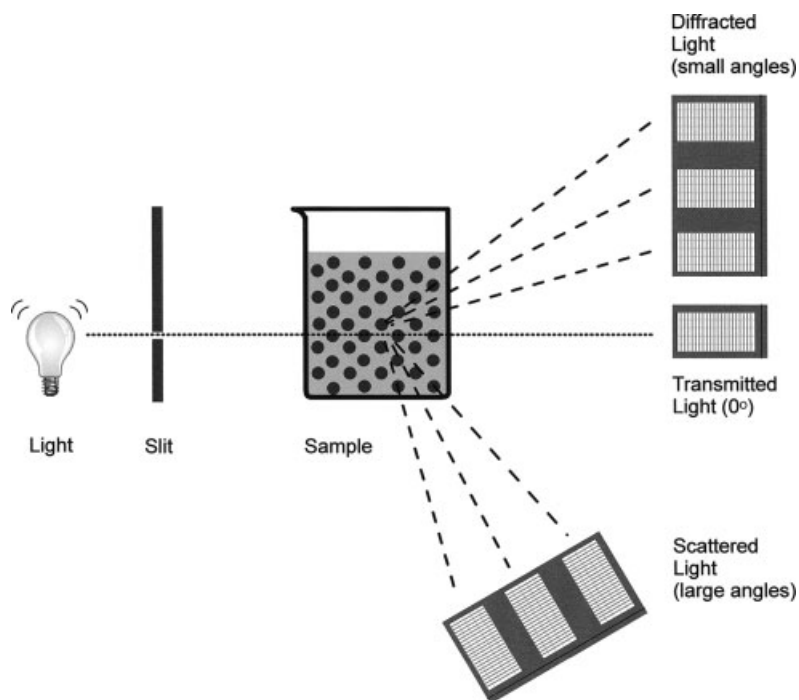
**Example.** The sailors' maxim "Red sky at night. Sailors delight. Red sky in the morning. Sailors take warning" can be explained in terms of Rayleigh theory. Since the scattering intensity is proportional to  $1/\lambda^4$ , blue light ( $\lambda = 450 \text{ nm}$ ) is scattered much more than red light ( $\lambda = 650 \text{ nm}$ ). With incident white light a dilute suspension of 0.1 to 1  $\mu\text{m}$  size droplets or particles will, therefore, tend to appear blue when viewed at right-angles to the incident light beam, and red when viewed end-on. Thus the sky can appear blue overhead while the sun appears yellowish-red when viewed across the horizon as it is rising or setting. If the air is disturbed by a storm then dispersed particles tend not to settle back to the earth at night, hence the red sky in the morning warning. This works best in the mid-latitudes of the northern hemisphere where storm systems generally follow the jet stream from west to east. A red sky over the setting sun at night is due to light-scattered dust particles in the air to the west (dust in the west indicating dry weather approaching). A red western sky in the morning indicates a sun rising in clear eastern skies illuminating storm clouds approaching from the west.

Rayleigh theory gives another relation from which particle sizes can be obtained [13,25]. In the limit as the particle concentration goes to zero,

$$Kc/R_{\theta} = M^{-1} + 2Bc \quad (2.11)$$

where the Rayleigh ratio,  $R_{\theta} = (I_s r^2 / \{I_o(1 + \cos^2 \theta)\})$ ,  $I_s$  is the light scattered per unit volume at distance  $r$  and angle  $\theta$ ,  $I_o$  is the incident light,  $M$  is the molar mass of particles,  $c$  is the concentration of particles,  $B$  is a virial coefficient, and  $K = (2\pi^2 n_o^2 / N_A \lambda^4) (dn/dc)^2$ .  $dn/dc$  is measured with a differential refractometer. Once  $M$  is obtained, a knowledge of the particle density allows calculation of the average equivalent spherical diameter. This approach can be used to obtain the size of very small particles, of the order of 20 nm diameter. For larger particles the theory is more involved [13,76].

Figure 2.7 shows a schematic of a light-scattering apparatus, illustrating three techniques. In Fraunhofer diffraction (small-angle scattering) of the incident beam, size information can be obtained for large species (if the dispersed species are of the order of, or larger than, the wavelength of the incident light). In turbidimetry (centre-right) attenuation of the incident light can indicate the amount of dispersed phase, but does not provide information about size distribution. Rayleigh and Mie scattering occurs through larger angles and for dispersed species that are smaller than the wavelength of the incident light. Variations of these techniques include detection of the scattered light as a function of angle, wavelength, or polarization of the incident light, or correlation of the scattered photons (photon correlation spectroscopy). Some practical problems emerge when applying these techniques to industrial samples, including:



**Figure 2.7** Schematic of a light-scattering apparatus illustrating Fraunhofer, low-angle diffraction (Upper right), turbidity (Centre right), and Rayleigh/Mie, large-angle scattering (Lower right).

- opacity of concentrated or oil-containing dispersions,
- the influence of thick interfacial layers having a refractive index different from the species they cover (especially for some emulsions),
- the need to assume a size distribution (some techniques),
- the difficulty of distinguishing between aggregates and individual species of the same overall size,
- the difficulty of distinguishing between solid particles and droplets or bubbles.

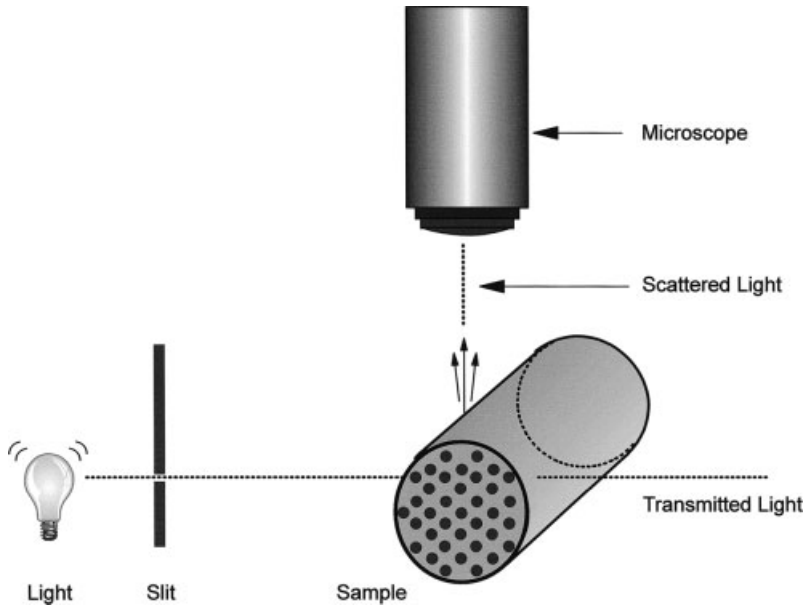
For more information see [66,68,77,78].

In addition to light, x-ray and neutron scattering can be used to obtain size distribution information [79,80]. The latter two techniques can provide information on smaller dispersed species sizes, down to about 0.5 nm.

#### 2.2.4

#### Ultramicroscopy

When a test tube containing a dilute suspension of very small particles is held up to the light, it will appear to have a blue colour due to Rayleigh scattering. Since this



**Figure 2.8** Schematic of an ultramicroscope (dark-field microscope) using the slit principle.

happens for particles so small that they would be invisible under the light microscope (less than about  $1\ \mu\text{m}$ ) the phenomenon provides a way to indirectly observe particles, droplets, or bubbles that would otherwise be invisible. In the dark-field microscope, or ultramicroscope, the light scattered by small dispersed species is viewed against a dark background. This permits their observation and counting. If the mass concentration of the dispersed species is also known, then the average mass of the dispersed species can be calculated, and their size estimated. Figure 2.8 illustrates the optical arrangement.

Ultramicroscopy is the preferred method for measuring the rate and/or extent of aggregation because it is direct. This method is also commonly used to observe the electrophoretic motions of colloidal species [81], as discussed in Section 4.3.1.

### 2.2.5

#### Other Techniques

There are many other indirect techniques for determining colloidal species' size or size distribution. These include sedimentation/centrifugation, conductivity, x-ray diffraction, gas and solute adsorption, ultrafiltration, viscometric, diffusometric, and ultrasonic methods [12,13,26,69,82]. Two reasons for the large number of techniques are the range of properties that can be influenced by the size of dispersed species, and the wide range of sizes that may be encountered. The grains in soils and sediments can range from colloidal size up to the size of boulders.

Care must be taken in selecting an indirect method since these require assumptions about either the real size distribution, the shape, or the process on which the analysis is based. For example, conductometric “sensing zone” equipment relies on the assumption of sphericity, which is usually reasonable for emulsion droplets, but often is not reasonable for particles in a suspension. Similarly, light-scattering techniques are reliable only if the particle shape and refractive index are known or assumed, and adsorption analyses rely on model adsorption isotherms, the uniformity of particle size and porosity, and the orientation of adsorbed species. Each technique has its own limitations. For example, concentrated dispersions are difficult to study by optical methods. In all cases one must be careful that sample preparation techniques do not change the size distribution [68]. In addition, the indirect size measurement techniques usually yield only an average value, and the type of average varies. That is, some techniques yield a number average, others a mass average, and others a volume average, and so on. Typically, more than one method is needed to characterize size and/or size distribution properly. A detailed description of other approaches to characterizing particles is given in references [1,69].

## 2.3

### Conductivity

#### 2.3.1

##### Dispersed Phase Identification

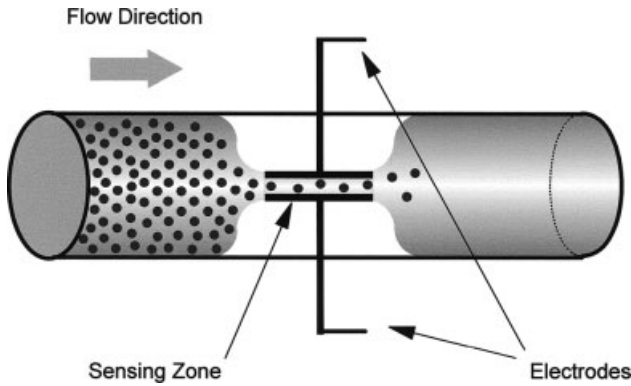
Conductivity can be used to distinguish O/W from W/O emulsions, since the conductivity is very high when the aqueous phase is continuous and conductivity is very low when oil is the continuous phase.

#### 2.3.2

##### Sensing-zone Techniques

The fact that the presence of solid particles can influence bulk conductivity forms the basis for a family of particle-size measuring techniques known as sensing-zone techniques. A well-known implementation of this is in the Coulter counter. A dilute suspension is allowed to flow through a small aperture (sensing zone) between two chambers (Figure 2.9). The conductivity (or resistance) between the chambers changes when a particle passes through the aperture. The degree of change is related to the particle volume, hence size. The sensing-zone techniques are not limited to conductivity, but may involve the measurement of capacitance. Capacitance monitoring, for example, has been used in a vertical sedimentation vessel [83] to estimate the solids concentration (expressed in terms of volume fraction). This method works best for spherical, or nearly spherical, particles.

Sensing-zone techniques have been applied to oil-in-water emulsions, although they cannot distinguish between dispersed droplets and solid particles [66]. Unless an emulsion sample contains no particles, or is very well characterized, the results



**Figure 2.9** Illustration of a sensing-zone technique. As the suspended particle or droplet passes through the sensing zone, the capacitance or resistance changes in proportion to the size of the particle. These signals can be sorted and interpreted as a size distribution in terms of equivalent spherical diameters.

can be difficult to interpret. For both suspensions and emulsions, conductimetric size determination is limited to diameters above about  $0.6\ \mu\text{m}$  [66,78].

### 2.3.3

#### Conductivity of Dispersions

Of the numerous equations proposed [84] to describe the conductivity of suspensions ( $\kappa$ ), one is cited here for illustration. The Bruggeman equation gives,

$$(\kappa - \kappa_D)(\kappa_C/\kappa)^{1/3} = (1 - \phi)(\kappa_C - \kappa_D) \quad (2.12)$$

where  $\phi$  is the dispersed phase volume fraction,  $\kappa_D$  is the conductivity of the dispersed phase, and  $\kappa_C$  is that of the continuous phase. If  $\kappa_C \gg \kappa_D$  then,

$$(\kappa/\kappa_C) = (1 - \phi)^{3/2} \quad (2.13)$$

Several other researchers [85,86] have developed similar equations that fit the general form:

$$(\kappa/\kappa_C) = (1 - \phi)^x \quad (2.14)$$

where  $x \geq 1$ .

Further discussion of suspension conductivity and some practical examples for solids concentration determination, and for suspensions flowing in pipelines, are given elsewhere [85,86].

Of the numerous equations proposed [37] to describe the conductivity of emulsions ( $\kappa_E$ ), two are cited here for illustration. If the conductivity of the dispersed phase ( $\kappa_D$ ) is much less than that of the continuous phase ( $\kappa_C$ ),  $\kappa_C \gg \kappa_D$ ,

$$\kappa_E = \{8\kappa_C (2-\phi)(1-\phi)\} / \{(4+\phi)(4-\phi)\} \quad (2.15)$$

where  $\phi$  is the dispersed phase volume fraction. If, on the other hand, the conductivity of the dispersed phase ( $\kappa_D$ ) is much greater than that of the continuous phase ( $\kappa_C$ ),  $\kappa_C \ll \kappa_D$ ,

$$\kappa_E = \kappa_C (1+\phi)(2+\phi) / \{(1-\phi)(2-\phi)\} \quad (2.16)$$

Further discussion of emulsion conductivity and some practical examples for emulsions flowing in pipelines are given in [85].

Bikerman [46] describes studies of the specific conductivity of individual foam lamellae. For bulk foams, the specific conductivity of the foam,  $\kappa_F$ , is proportional to the volume fraction of liquid in the foam and its conductivity,  $\kappa_L$ :

$$\kappa_L / \kappa_F = f \rho_L / \rho_F \quad (2.17)$$

where  $f$  is also a function of  $\rho_L / \rho_F$ . The proportionality constant  $f$  typically varies from about 2.0 to 2.5, although in the limit of  $\rho_L / \rho_F = 1$  then  $f=1$  also since, in this limit, foam no longer exists at all.

## 2.4

### Sedimentation, Creaming, and Centrifugation

#### 2.4.1

##### Sedimentation and Creaming

Whereas the use of light scattering to determine a complete size-range distribution is quite involved, if the particles or droplets are not too small, a simpler approach can be used that yields an approximate average size. This is done by measuring settling velocities. If an uncharged droplet or particle is placed in a fluid it will fall, or sediment out, if its density is greater than that of the fluid. For the small particles in a dust cloud, or suspended sediment in a river, it is principally the small size that keeps these particles from rapidly settling out. Whereas a fine sand particle of 100  $\mu\text{m}$  diameter will settle through a 1 m column of water in about 2 minutes, a 1  $\mu\text{m}$  bacterium particle will take about 8 days, and a 10 nm colloidal particle will take about 20 years (in the absence of turbulence).

As long as there is a density difference between the phases, emulsion droplets, foam bubbles, and suspension particles will have some tendency to rise or settle, possibly according to Stokes' law. Whereas a body in a fluid will sediment out if its density is greater than that of the fluid, it will rise if its density is lower (this is called

negative sedimentation, or creaming). The term creaming comes from the familiar separation of cream from raw milk. Whether sedimentation or creaming, the driving force,  $f_g$ , in the phenomenon is that of gravity:

$$f_g = mg = v(\rho_2 - \rho_1)g = (4/3) \pi a^3 (\rho_2 - \rho_1)g \quad (2.18)$$

where  $a$  is the particle (droplet, bubble) radius,  $v$  the particle (droplet, bubble) volume,  $\rho_2$  the particle (droplet, bubble) density,  $\rho_1$  the continuous phase density, and  $g$  the gravitational constant. The sedimenting particles must push solvent molecules out of the way and along their surfaces, so the particle motion is resisted by a force related to the solvent viscosity. If the flow is laminar, the resistance is approximately proportional to the particle velocity. After a short period of time the particle reaches a terminal (constant) velocity  $dx/dt$  when the two forces are matched. Thus:

$$(4/3) \pi a^3 (\rho_2 - \rho_1)g = f (dx/dt) \quad (2.19)$$

Here  $f$  is the frictional coefficient for the particle which is given by Stokes' law as  $f = 6 \pi \eta a$  where  $\eta$  is the fluid viscosity. Thus:

$$(dx/dt) = (2 a^2 (\rho_2 - \rho_1)g) / (9\eta) \quad (2.20)$$

This equation shows why, for example, aggregated droplets in an emulsion cream faster than individual droplets, and why coagulated solids in a suspension usually sediment faster than individual particles (in both cases the effective radius is larger).

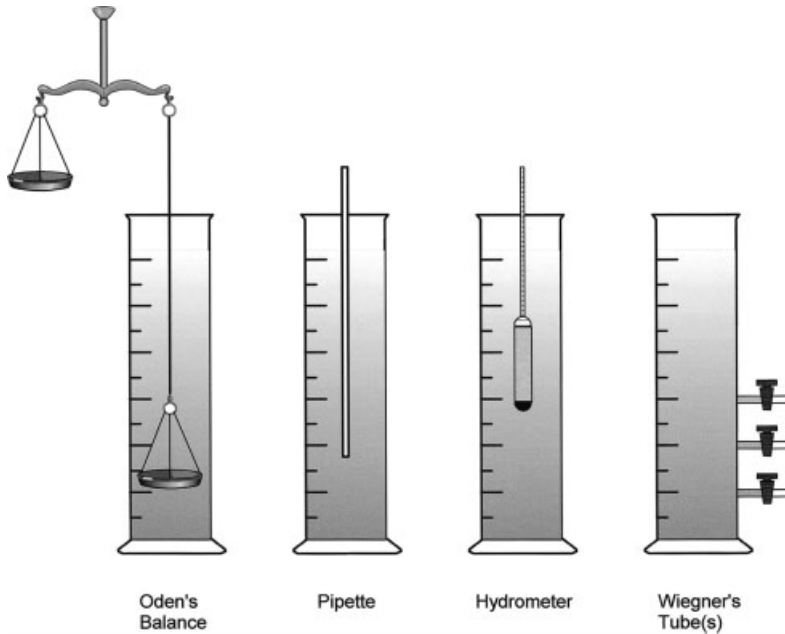
In the Stokes model the terminal settling velocity is proportional to gravity and the square of particle size, and inversely proportional to the fluid viscosity [12,13,26]. This assumes that the species is uncharged and spherical, the situation being more complicated for charged and/or asymmetric species. Charged species, when sedimenting, present a challenge to Stokes' law because the smaller counter-ions sediment at a slower rate than do the larger colloidal particles. This creates an electrical potential that tends to speed up the counter-ions and slow down (drag) the particles. At high enough electrolyte concentrations the electric potentials are quickly dissipated and this effect vanishes. Since droplets and bubbles are not rigid spheres, they may deform in shear flow. Also, with the presence of emulsifying agents at the interface, the drops will not be non-interacting, as is assumed in the theory.

The sedimentation velocity can be used to yield a good estimate of the average dispersed species size as long as the particles are not too small.

**Example.** Consider a sample of solid particles for which the average particle size is unknown. The particle density is known ( $2 \text{ g/cm}^3$  at  $20^\circ\text{C}$ ) and a sedimentation column (see Figure 2.10) is filled with the solids suspended in water. Measurements indicate a terminal velocity of  $0.013 \text{ cm/minute}$ . What is the average particle diameter?

$$(dx/dt) = (2 a^2 (\rho_2 - \rho_1)g) / (9\eta)$$





**Figure 2.10** Illustration of some approaches to using sedimentation rates to determine particle size distributions in suspensions.

$$a^2 = \frac{(0.013 \text{ cm/min})(1 \text{ min}/60 \text{ s})^2 (1 \text{ mPa}\cdot\text{s})}{2(2 \text{ g/mL} - 1 \text{ g/mL})(9.807 \text{ ms}^{-2})}$$

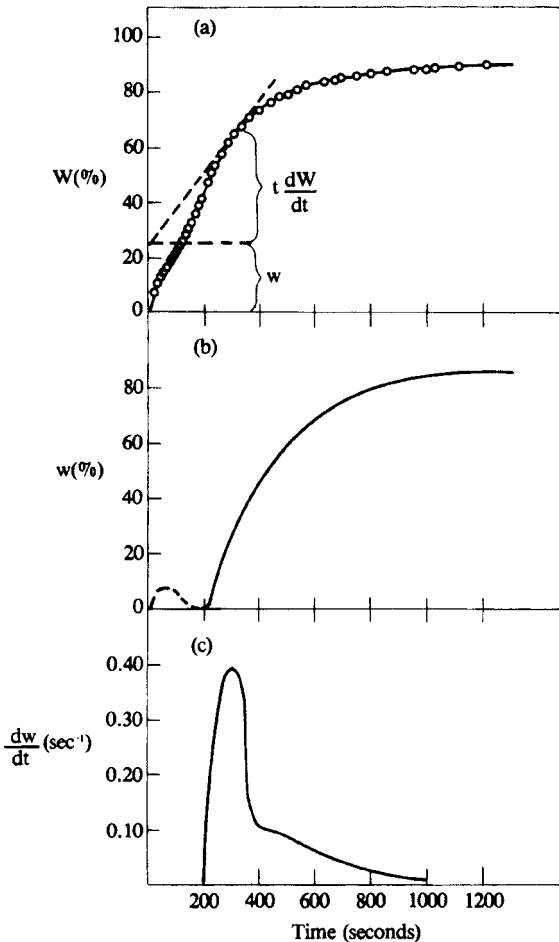
$$= 0.994 \times 10^{-8} \text{ cm}^2 \quad (1 \text{ mPa}\cdot\text{s} = 1 \text{ g m}^{-1} \text{ s}^{-1})$$

$a = 1.00 \text{ }\mu\text{m}$ , so the average diameter is  $2a = 2.00 \text{ }\mu\text{m}$ .

If instead the particles had an average diameter of only  $0.2 \text{ }\mu\text{m}$  ( $a = 0.1 \text{ }\mu\text{m}$ ), the terminal settling velocity would be  $dx/dt = 1.3 \times 10^{-4} \text{ cm/min} = 70 \text{ cm/year}$ ; dramatically slower!

Sedimentation velocities may be measured with a special balance; consider the illustration of the Oden balance in Figure 2.10. As sedimentation takes place a layer of sediment collects on the submerged balance pan whose weight,  $W$ , can be determined at various times,  $t$ . Some values for  $W$  measured during settling of clay particles in water are shown in Figure 2.11 (a) [87].  $W$  is the weight of all particles large enough to have settled onto the pan by each time  $t$ . This weight comprises (a) the weight,  $w$ , of all particles large enough to have settled all the way from the top of the container, and (b) the weight of those particles that have only settled a fraction of the height of the column, but which still fall onto the balance pan,  $t(dW/dt)$ . The cumulative weight is given by:

$$W = w + t(dW/dt) \quad (2.21)$$



**Figure 2.11** Sedimentation of clay particles in an Oden balance experiment, showing the cumulative weight (%) versus time (a), cumulative weight of oversize material (%) versus time (b), and frequency by weight versus time (c). From Hiemenz [87]. Copyright 1986, Dekker.

Here  $dW/dt$  is the slope of the cumulative curve at a particular time value, and is a measure of the rate of incidence of particles smaller than the cut-off size associated with that time value. Figure 2.11 (a) shows how tangents to the curve yield values of  $w$  at different times. In Figure 2.11 (b) a plot of  $w$  versus  $t$  shows the weight contribution at any given time due to particles larger than the cut-off size associated with each time. Since this is an integrated size distribution curve for particles larger than the cut-off size, a derivative will yield the distribution of particle sizes in the sample. Figure 2.11 (c) shows such a graphical differentiation, taking the slopes at different points of graph (b). The size distribution curve shows a marked peak for a particle

size that settles in about 300 s. (Note that very accurate experimental data are needed if one is to obtain accurate graphical derivatives.) In this example, the height of the column from the balance pan was 0.20 m and the density difference between the phases was 2.17 g/cm<sup>3</sup>. From Eq. (2.20), the equivalent spherical radius for the clay particles, corresponding to the 300 s settling time, is 12 μm. This approach is described further elsewhere [69,88,89].

Equation (2.20) also assumes laminar flow (Reynolds numbers less than about 0.1), i.e., low particle velocities, and a dilute suspension of particles that are large compared with the molecules of the fluid. For Reynolds numbers greater than about 0.1 but less than 1, Oseen's law is approximately:

$$(dx/dt) \sim \{2/[1 + (1 + 18\text{Re}/24)^{1/2}]\} (2 a^2 (\rho_2 - \rho_1)g) / (9\eta) \quad (2.22)$$

where Re is the Reynolds number (as the Reynolds number increases the drag coefficient becomes more important and Oseen's law becomes somewhat more complex [53]). Overall, Oseen's law gives somewhat smaller settling velocities than Stokes' law.

For asymmetric particles several other models are available [53,90]. An example is the equation for the settling of a circular disk, settling broadside on:

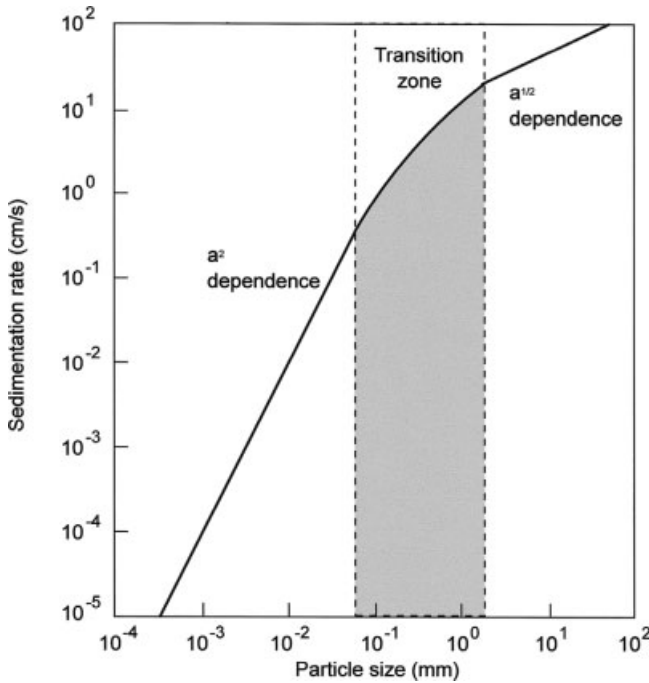
$$(dx/dt) = (\pi ab(\rho_2 - \rho_1)g) / (12\eta) \quad (2.23)$$

where the radius is a and the thickness is b.

At low speeds, asymmetric particles will have constantly changing orientation. This can be accounted for by a frictional coefficient averaged over all the orientations,  $f$ . For particles of equal volume,  $f$  increases with asymmetry since the increased resistance of the side-on orientation outweighs the reduced resistance of the end-on orientation compared with spherical particles [13]. Particle solvation is also important. The frictional coefficient of dry, unsolvated spheres of the same radius is given as  $f_0$ . The frictional ratio  $f/f_0$  is thus a measure of asymmetry and solvation. Finally, if the dispersed species concentration is high then the species do not sediment independently, but are influenced by the motions of surrounding particles producing slower, hindered, settling.

Finally, sedimentation at Reynolds numbers greater than one is the realm of empirical equations. Several of these have been developed, mostly as fits to experimental data sets. Some of these are discussed and illustrated by Nguyen and Schulze [53].

Unfortunately, the situation in many practical applications involves larger-sized, non-spherical particles, at high Reynolds numbers. This includes the sedimentation of particles in natural water bodies, and in many industrial process situations. In particular, Stokes' law fails to apply well for particles larger than about 180 μm. For smaller particles sedimenting in quiescent water, the settling velocity increases with  $a^2$  and the flow around the particles remains laminar. For much larger particles sedimenting is rapid enough to create turbulent flow around the particles, and the set-



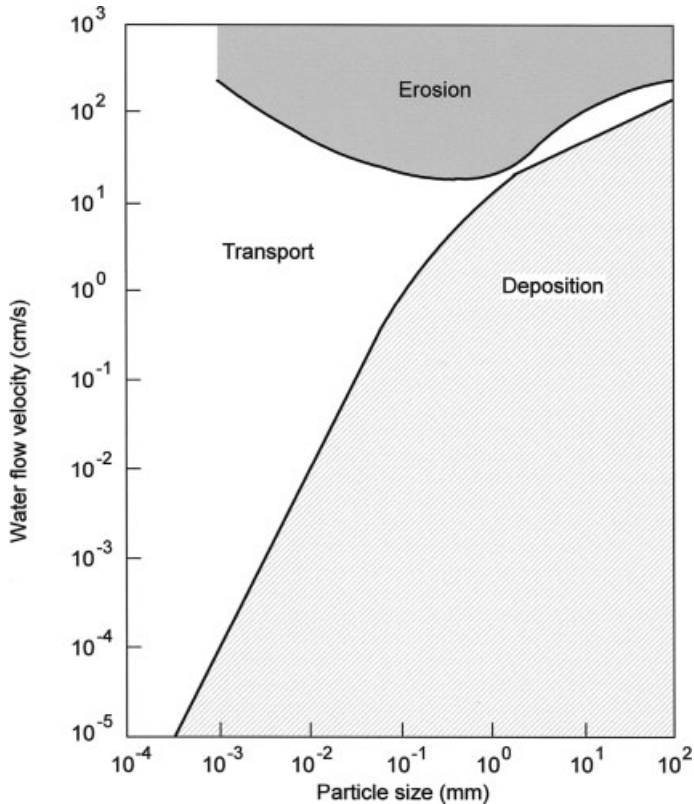
**Figure 2.12** Illustration of the sedimentation rates for average-shape quartz grains in water showing the regions within which the rates are proportional to  $a^2$ ,  $a^{1/2}$ , or in transition between these two. For comparison, a sedimentation rate of 0.01 cm/s (near the centre of the vertical scale) corresponds to about 3 km/year. Drawn based on data and equations in Yariv and Cross [49].

ting velocity only increases with  $a^{1/2}$ . Between these extremes there is a transition from laminar to turbulent flow, as illustrated in Figure 2.12.

If the continuous phase is in motion, then smaller particles will remain suspended. Figure 2.13 shows the effect of different continuous-phase flow velocities on whether sand grains of various sizes will sediment (be deposited) or remain suspended (transported). This illustration also shows that it is more difficult to suspend a particle than to maintain it in suspension. Table 9.2 shows terminal sedimentation velocities for different sized particles in seawater.

Changing the shape of the dispersed species while flowing also has an impact. Since emulsion droplets and foam bubbles are not rigid spheres, they may deform in shear flow. In the cases of electrostatically interacting species, or those with surfactant or polymeric stabilizing agents at the interface, the species will not be non-interacting, as is assumed in the theory. Thus, Stokes' law will not strictly apply and may underestimate or even overestimate the real terminal velocity.

With their lower viscosity, bubbles will deform more readily than emulsion droplets and therefore be relatively more prone to depart from Stokes' law behaviour.



**Figure 2.13** Illustration of the relationship between the water flow velocity and the fate of sediment particles. At low velocities the larger particles sediment out if originally suspended, or, if originally residing in the sediment, they remain in place (lower right zone); note that this is the sedimentation velocity curve from Figure 2.12. At intermediate velocities

suspended particles remain suspended and are transported with the flowing water (centre zone); the smaller particles in the sediment are picked-up and become suspended. At very high velocities particles will be eroded from the sediment layer (upper zone). From Figure 2.12 plus data from Yariv and Cross [49].

Hadamard and Rybczynski developed a terminal velocity equation for the creaming of bubbles with a mobile surface:

$$\left(\frac{dx}{dt}\right) = (a^2 \rho_1 g) / (3\eta) \quad (2.24)$$

where  $\rho_1$  is the continuous phase (liquid) density. More detailed theory is available elsewhere [53,76,91].

The creaming process, in which emulsion droplets rise or settle without significant coalescence, is not, by itself, emulsion breaking. Creaming produces two separate layers of emulsion that have different droplet concentrations and are usually distinguishable from each other by colour or opacity. Creaming does promote coa-

lescence by increasing the droplet crowding and hence the probability of droplet-droplet collisions. It can be seen from Stokes' law that creaming will occur faster when there is a larger density difference and when the droplets are larger. In general, for given liquid densities, creaming will occur more slowly the greater the electrical charge on the droplets and the higher the emulsion viscosity.

As suggested by Eq. (2.20) viscosity also has an important influence on settling velocity.

**Example.** In the primary flotation vessel of an oil sands processing plant, two different process conditions yield the following data for the flotation of bitumen: mean bitumen droplet diameter, 0.26 mm, mean droplet density,  $0.97 \text{ g/cm}^3$ , both at a process temperature of  $80^\circ\text{C}$ .

Slurry condition 1: density,  $1.33 \text{ g/cm}^3$ ; viscosity,  $89 \text{ mPa}\cdot\text{s}$

Slurry condition 2: density,  $1.20 \text{ g/cm}^3$ ; viscosity,  $3.2 \text{ mPa}\cdot\text{s}$

From the slurry introduction point, bitumen droplets must rise a distance of 0.80 m within the mean vessel residence time of 45 min in order to reach the froth layer and be recovered. What kind of oil recovery efficiencies would be predicted for each case?

For condition 1 the settling velocity ( $dx/dt$ ) is  $-0.015 \text{ cm/s}$  (negative means rising) and the rise time  $\{-x/(dx/dt)\}$  is 89 min, which is much greater than 45 min. In this case the droplets need much more time to rise than is allowed in the vessel so recovery efficiency will be poor.

For condition 2 the settling velocity is  $-0.265 \text{ cm/s}$  and the rise time is 5.0 min, much less than 45 min. In this case the droplets need much less time to rise than is allowed in the vessel so recovery efficiency will be good, other factors being equal. In practice the situation is somewhat more complex, as discussed in Ref. [92].

The situation is more complicated when the particles are charged because the smaller counter-ions sediment at a slower rate than do the larger colloidal particles. This creates an electrical potential that tends to speed up the counter-ions and slow down (drag) the colloidal particles. At high enough electrolyte concentrations the electric potentials are quickly dissipated and this effect vanishes.

If the particle concentration in a suspension is high, then the particles do not sediment independently, but are influenced by the motions of surrounding particles (hindered settling). Hindered settling behaviour can be described by applying a correction factor to the Stokes' Law terminal settling velocity ( $dx/dt$  from Eq. 2.20) to obtain a hindered settling velocity. Several equations have been advanced to describe the correction [69]. The Richardson–Zaki equation for this is:

$$(dx/dt)' = (dx/dt) (1-\phi)^{4.65} \quad (2.25)$$

where  $\phi$  is the dispersed-phase volume fraction ( $\phi < 1$ ). The exponent 4.65 was found by Richardson and Zaki for particles greater than  $1 \mu\text{m}$ . For particles smaller than  $1 \mu\text{m}$  in diameter, the exponent has been found to increase to about 5.25 [93].

Creaming is important in a wide variety of areas. Whereas the above examples have involved desirable creaming, there are many situations in which creaming is undesirable. Many formulated products are emulsions and/or suspensions, such as food products (see Chapter 13). In these kinds of products, especially food emulsions, as much as 40% of the cost of developing a new product can be in controlling creaming [94]. One way to retard creaming follows directly from Stokes' law, Eq. (2.20), in which "thickening" polymers are formulated into the dispersion to raise the viscosity and proportionally decrease the creaming rate.

#### 2.4.2

#### Centrifugation and Ultracentrifugation

Sedimentation under gravity is only practical for dispersed species having diameters down to about 1  $\mu\text{m}$ . A centrifuge can be used to study sedimentation of colloidal systems since the added centrifugal forces can be employed to overcome the mixing tendencies of diffusion and convection. Centrifugal force, like gravitational force, is proportional to the mass, but the coefficient is not the acceleration due to gravity,  $g$ , but rather  $\omega^2 x$  where  $\omega$  is the angular velocity ( $= 2\pi \times \text{rev. per sec.}$ ) and  $x$  is the distance of the particle from the axis of rotation. Thus, the driving force for sedimentation becomes  $m(\rho_2 - \rho_1) \omega^2 x$  and the terminal velocity becomes:

$$dx/dt = (2 a^2 (\rho_2 - \rho_1) \omega^2 x) / (9\eta) \quad (2.26)$$

Since  $\omega^2 x$  is substituted for  $g$  in the governing equation, one speaks of multiples of  $g$  in a centrifuge. For example, using a conventional laboratory bench-top centrifuge capable of applying thousands of "gs" one can reduce the time needed to sediment out 0.2  $\mu\text{m}$  particles, from an aqueous suspension, to about 20 minutes compared with the 16 days that would be needed to achieve the same sedimentation from a standing column. The centrifugal acceleration in a centrifuge is not really a constant throughout the system, but varies with  $x$ . However, since the actual distance from top to bottom of a sedimenting column is usually small compared to the distance from the axis of revolution, the average acceleration may usually be used without introducing a large error.

**Example.** How long would one need to centrifuge the 0.2  $\mu\text{m}$  particles, from the previous example, in a centrifuge capable of 3000 rpm with an effective  $x = 10 \text{ cm}$ ? Assume we need to settle the particles by 3 cm to strike the wall in an angled centrifuge tube.

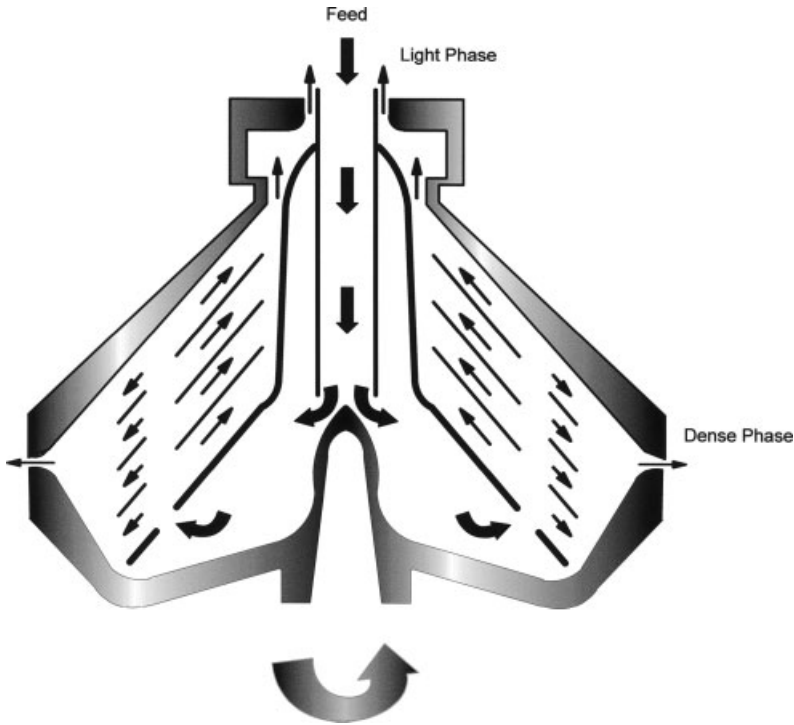
$$\begin{aligned} (dx/dt) &= (2 a^2 (\rho_2 - \rho_1) \omega^2 x) / (9\eta) \\ &= \{2(0.1 \times 10^{-6} \text{ m})^2 (2 \text{ g/mL} - 1 \text{ g/mL})(10 \text{ cm})(2\pi \text{ 3000 rpm})^2\} / \\ &\quad 9(1 \text{ mPa}\cdot\text{s}) \\ &= 2.193 \times 10^{-5} \text{ m/s} = 0.132 \text{ cm/min} \end{aligned}$$

Notice that  $\omega^2 x = 9.87 \times 10^5 \text{ cm s}^{-2} = 1000 \text{ g}$

and  $(dx/dy)_{\text{gravity}} = (dx/dy)_{\text{centrifuge}} / 1000$

In this case, to sediment the 3 cm in the tubes takes  $(3 \text{ cm}) / (0.132 \text{ cm/min}) = 23 \text{ min}$ . This is better than the 16 days needed in a column!

Continuous centrifuges of the type used in commercial processing plants (see Figure 2.14) can generate centrifugal forces in the thousands of gs.



**Figure 2.14** Cut-away illustration of the internals of a high-speed, continuous, disc-nozzle centrifuge.

**Example.** Bitumen is recovered in the form of a froth when a separation–flotation process is applied to surface mined oil sand. Once de-aerated, this bituminous froth is a W/O emulsion from which the water must be removed prior to upgrading and refining. At process temperature ( $80^\circ\text{C}$ ) the emulsion viscosity is similar to that of the bitumen, but the density, due to entrained solids, is higher. Taking  $\eta = 500 \text{ mPa}\cdot\text{s}$  and  $\rho_1 = 1.04 \text{ g/mL}$ , the rate of creaming of  $20 \mu\text{m}$  diameter water droplets under gravitational force will be very slow:

$$\begin{aligned} dx/dt &= (2 a^2 (\rho_2 - \rho_1) g) / (9\eta) \\ &= -3.05 \times 10^{-6} \text{ cm/s} = 96 \text{ cm/year (upwards)} \end{aligned}$$

In the commercial process, a centrifuge process is used to speed up the separation. The continuous centrifuges can operate at 2500 gs, the droplets hav-



ing to travel 9 cm to reach the product stream. With the centrifugal force added, the droplet velocity would become:

$$\begin{aligned} dx/dt &= (2 a^2 (\rho_2 - \rho_1) \omega^2 x) / (9\eta) \\ &= 2500(dx/dt) = 7.63 \times 10^{-3} \text{ cm/s} \end{aligned}$$

This is 2500 times faster than with gravity alone, but the residence time in the centrifuge would have to be about 20 minutes, which is not practical. To speed up the separation, naphtha is added to the level of 25%. This lowers the viscosity to about 4.5 mPa·s and lowers the density of the continuous phase to 0.88 g/mL. Note that now the water drops would sediment rather than cream under gravitational force, and while the emulsion density is much reduced, the absolute value of the density difference changes very little:  $\Delta\rho = -0.07$  g/mL originally, and becomes  $\Delta\rho = +0.09$  g/mL! The overall effect is to lower the viscosity by about two orders of magnitude. The droplet velocity now becomes  $(dx/dt)'' = 1.1$  cm/s, which yields a satisfactory residence time of about 8 seconds.

The ultracentrifuge can be used to study sedimentation of very finely divided colloidal systems since very high centrifugal forces can be employed, of the order of 100 000 g. In the velocity method a high centrifugal force (ca. 400 000 g) is applied and the movement of the boundary created by particle sedimentation is measured versus time. The driving force for sedimentation becomes  $m(\rho_2 - \rho_1) \omega^2 x$  where  $\omega$  is the angular velocity and  $x$  is the distance of the particle from the axis of rotation. The frictional resisting force is  $fdx/dt$  where  $Df = kT$ . Therefore, one can get an expression from which, if  $D$  is known, particle or polymer masses can be determined:

$$dx/dt = mD(\rho_2 - \rho_1)\omega^2 x / (kT) = MD(\rho_2 - \rho_1)\omega^2 x / (RT) \quad (2.27)$$

where  $M$  is the molar mass. Defining a sedimentation coefficient,  $S = (dx/dt)/(\omega^2 x)$ , and integrating with respect to time yields:

$$M = RT \ln(x_2/x_1) / \{D(\rho_2 - \rho_1)(t_2 - t_1)\omega^2\} \quad (2.28)$$

In this method  $D$  must be known independently.

In the sedimentation–equilibrium method a lower centrifugal field is applied and the processes of sedimentation and diffusion are brought to equilibrium [13]. In this case the governing equation contains sedimentation equilibrium concentrations of species at different positions from the axis of rotation, but one does not need to know  $D$ . It should be pointed out that sedimentation and diffusion are more complicated when the species are electrically charged. This is because the smaller counterions sediment at a slower rate than do the colloidal-sized species. This creates an electric potential gradient that tends to speed up the counter-ions and to drag the colloidal species. The reverse effect occurs for diffusion.

## 2.5

### Characterization of Emulsions

#### 2.5.1

##### Appearance and Emulsion Type

Not all emulsions exhibit the classical “milky” opaqueness with which they are usually associated. A tremendous range of appearances is possible, depending upon the droplet sizes and the difference in refractive indices between the phases. An emulsion can be transparent if either the refractive index of each phase is the same, or alternatively, if the dispersed phase is made up of droplets that are sufficiently small compared with the wavelength of the illuminating light. Thus an O/W micro-emulsion of even a crude oil in water may be transparent. If the droplets are of the order of 1  $\mu\text{m}$  diameter a dilute O/W emulsion will take on a somewhat milky-blue cast; if the droplets are very much larger then the oil phase will become quite distinguishable and apparent. Physically the nature of the simple emulsion types can be determined by methods such as [95]:

##### Texture

The texture of an emulsion frequently reflects that of the external phase. Thus O/W emulsions usually feel “watery or creamy” while W/O emulsions feel “oily or greasy”. This distinction becomes less evident as the emulsion viscosity increases, so that a very viscous O/W emulsion may feel oily.

##### Mixing

An emulsion readily mixes with a liquid that is miscible with the continuous phase. Thus, milk (O/W) can be diluted with water while mayonnaise (W/O) can be diluted with oil. Usually, an emulsion that retains a uniform and milky appearance when greatly diluted is more stable than one that aggregates upon dilution [96].

##### Dyeing

Emulsions are most readily and consistently coloured by dyes soluble in the continuous phase (e.g., methylene blue for water or fuschin for oil [66].

##### Conductance

O/W emulsions usually have a very high specific conductance, like that of the aqueous phase itself, while W/O emulsions have a very low specific conductance. A simple test apparatus is described in [96].

##### Inversion

If an emulsion is very concentrated, it will probably invert when diluted with additional internal phase.

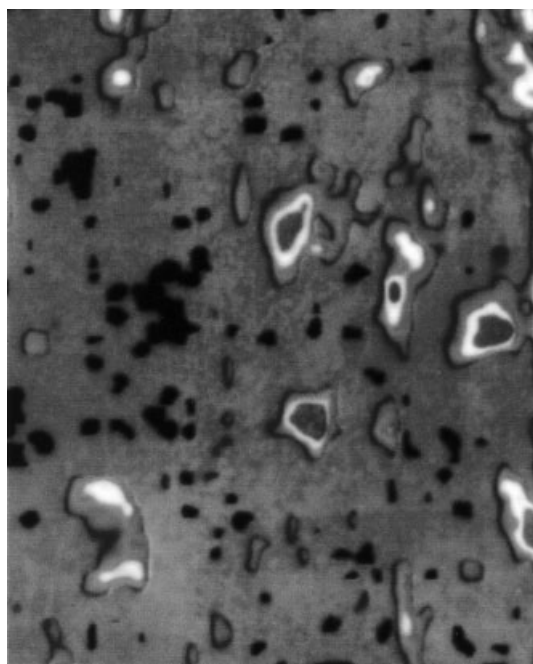
### Fluorescence

If the oil phase fluoresces then fluorescence microscopy can be used to determine the emulsion type as long as the drop sizes are larger than the microscope's limit of resolution ( $> 0.5 \mu\text{m}$ ). See [66].

### MRI Imaging

Magnetic resonance imaging (MRI) is sensitive to any NMR-active nuclei, such as protons. This allows one to distinguish different chemical environments in which these nuclei find themselves, including oil versus water. Figure 2.15 shows a NMR reconstructed image slice taken through the centre of a complex, oil-continuous emulsion sample [97]. Additional examples can be found in [98].

As mentioned earlier, emulsions do not always occur in the idealized form of drops of one phase dispersed in another. The occurrence of double and multiple emulsions, of the types O/W/O, W/O/W, O/W/O/W, etc., has already been mentioned (See Figure 1.2). In these cases the above techniques can sometimes be used to determine the continuous phase, but not always. For example, the dye test may produce misleading results when applied to a multiple emulsion, or to a bi-continuous emulsion. In particular, it is very difficult to follow the aggregation and/or coa-



**Figure 2.15** Reconstructed image from a magnetic resonance imaging (MRI) slice taken through the centre of an oil-continuous emulsion containing water and solids. The oil appears as grey while the water appear as white, and the solids as black. The larger oil-in-water-in-oil emulsion droplets are about  $200 \mu\text{m}$  in diameter.

lescence of the internal droplets in a multiple emulsion. Their characterization is usually best accomplished by techniques, such as optical and electron microscopy, that permit direct observation of the dispersed phases [52,66,68].

### 2.5.2

#### Experimental Assessment of Emulsion Stability

Bottle or jar tests are commonly used to evaluate emulsifier and demulsifier performance. Samples of the emulsion components and the emulsifier to be tested, or of an existing emulsion and the demulsifier to be tested, are mixed in bottles or jars in a specified way, then allowed to stand for a specified period of time. Depending upon the process being tested or developed, other additives (e.g., diluents) may be added, the temperature may be varied, or the samples may be centrifuged. After a defined period of time, the stabilized or de-stabilized emulsions are examined. In the stabilizing of emulsions one looks for a stable, homogeneous emulsion with little or no separated phase. In the breaking of emulsions, one looks for phase separation, “brightness” of the oil phase (a bright, shiny, oil phase is indicative of a low water content), clarity of the water phase, and sharpness of any interface(s) present. If measurements and/or observations are made over time, the rate of emulsion separation into individual oil and water layers can also be determined. The oil and/or water phases may also be further evaluated by centrifugation to determine any residual emulsified phase water content (this may include dilution before centrifuging, in the case of the oil). There are many variations of the bottle/jar test procedure (see also [66,68]). For an example of a detailed bottle test procedure, see that given by Leopold [99].

Bottle/jar tests, conducted in the actual industrial plant or field, are the most reliable way to assess demulsifier performance because of the difficulties introduced by transporting and storing emulsion samples. The transportation can introduce shear or turbulence that can induce changes in the nature and stability of emulsions, and can induce increased or decreased stability. The stability of aged emulsions can also increase or decrease if, with time, stabilizing components are able to change the orientations in the interface, or diffuse into or out of the interface. Oilfield emulsions, for example, contain asphaltenes and other surface-active components that tend to increasingly stabilize dispersed water droplets with time in storage.

Bottle/jar tests do have limitations. It can be difficult to reproduce the actual process temperature, pressure, and flow conditions, so in some cases the results may not scale-up to actual operational conditions. Mikula and Munoz [68] show the differences in jar test performance that can result from wall effects alone.

Beyond the bottle/jars tests and their acceleration by centrifugation, other methods have been applied to the study of emulsion stability including [100–102]:

- optical methods, such as light scattering, photon correlation spectroscopy, and turbidimetry,
- dielectric constant or electric conductivity (“sensing zone”) measurements, in the upper or lower regions of the emulsions,
- NMR, calorimetric, and ultrasonic velocity measurements.

## 2.5.3

**Composition**

An important aspect of emulsion characterization is composition. The oil is frequently a simple hydrocarbon liquid, lipid<sup>1)</sup>, or crude oil. The relative amounts of oil and water are almost always important in emulsion applications, but not exclusively. In many application areas the presence and concentration of solid particles and other dissolved components are also very important. A number of standard methods for determining oil, water, and solids contents are available [103–106]. The classical Dean–Stark method involves placing an emulsion sample in a porous thimble and refluxing with an appropriate organic solvent. The solids are retained in the thimble, the water is distilled off and trapped, and the oil dissolved in the solvent and carried through the thimble to a separate trap. The oil phase can be further treated by centrifuging to remove any fine solids that passed through the thimble, allowing a separate determination of fine solids content [66]. A simpler approach is to dilute the emulsion with an appropriate solvent and centrifuge the sample. This allows oil, water, and solids to be directly read, in terms of volumes, from a suitably graduated centrifuge tube [66]. The water and solids tend to be centrifuged out together and are often reported as a composite volume, termed basic sediment and water (BS&W). A demulsifier can also be added to assist with the separation of the phases. This technique is less accurate than the Dean–Stark method, but is faster and suitable for use in an operating plant or in field operations.

If the emulsion does not contain solids, then the determination of water and oil can usually be easily and accurately determined by Karl Fischer titration [66,107]. Other, less accurate, methods include [66]: conductivity, capacitance, and gamma-ray or microwave [108] attenuation.

**2.6****Characterization of Foams**

## 2.6.1

**Appearance and Foam Type**

Between the time a liquid film is first formed, until it thins to an equilibrium black film, the thickness can be measured by techniques based on the interference of light. For monochromatic light, the intensity of light,  $I_R$ , reflected at angle  $\theta$  from a fluid film compared to the maximum intensity yielded by constructive interference,  $I_0$ , enables the determination of the film thickness,  $t$ , as:

$$t = (\lambda / 2\pi\mu \cos\theta) \sin^{-1} (I_R/I_0)^{1/2} \quad (2.29)$$

- 1) Lipids are fatty acids or closely related compounds, such as palmitic, oleic, linoleic, linolenic, ricinoleic, and arachidic acids.

where  $\mu$  is the refractive index and  $\lambda$  is the wavelength. If white light is used then interference will produce coloured fringes in the film that can be used to determine the film thickness and also its variation over the surface of the film. This can be used to experimentally study film drainage and thinning processes. Some examples are given by Isenberg [45]. If the thickness of the film is much less than that of the illuminating light then the film will appear black (5–30 nm). At larger thicknesses the shorter wavelength components of the illuminating light will begin to interfere constructively and coloured fringes will appear, with colours due to longer wavelength components being added as the thickness increases further (30–120 nm). When these liquid films naturally thin they may reach a meta-stable film thickness (in the secondary minimum), typically about 30 nm, the coloured fringes disappear and the film is termed a common black film. With further thinning they may reach a more stable thickness (in the primary minimum), typically about 5 nm, in which case the film is termed a Newton black film.

For bulk foams, some researchers have used a variation of the turbidity Eq. (2.9) by fitting the intensity of light transmitted through a sample of foam ( $I_t$ ) to an equation of the form:

$$I_0/I_t = an_F + b \quad (2.30)$$

where  $I_0$  is the intensity of incident light,  $n_F$  is the number of foam lamellae per unit path length, and  $a$  and  $b$  are empirical constants. Equation (2.30) can be used as the basis for a method of measuring foam decay.

One of the simplest representations for foam drainage, in terms of the drained volume of liquid, is given by:

$$\Delta V = V_0 - (1/kt) \quad (2.31)$$

where  $\Delta V$  is the drained volume of liquid,  $V_0$  is the initial volume of liquid in the foam,  $k$  is a constant that depends on the particular foam, and  $t$  is time. Equation (2.31) applies to large values of  $t$ . More accurate, and complicated, relationships for foam drainage are discussed by Weaire *et al.* [109].

The density of foams has been measured by such techniques as capacitance, resistance, and MRI imaging [109]. In calculating the density of a foam ( $\rho_F$ ) one can usually ignore the mass of gas involved so that:

$$\rho_F = m_L/V_F \quad (2.32)$$

where  $m_L$  is the mass of liquid in the foam and  $V_F$  is the total volume of the foam. For foams made from a liquid of density  $\rho_L$  and volume  $V_L$ :

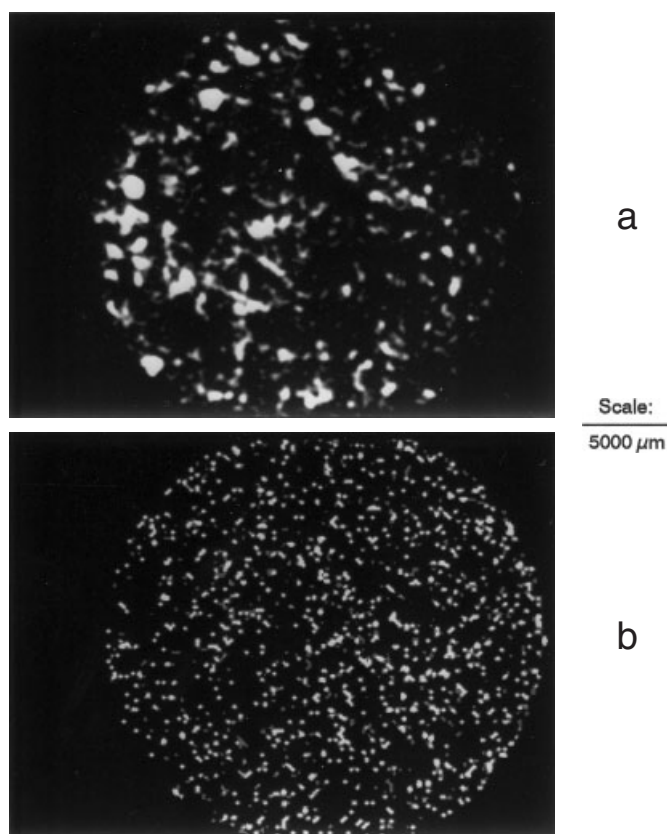
$$\rho_L/\rho_F = V_F/V_L \quad (2.33)$$

Equation (2.33) forms the basis for some further terminology. The factor  $V_F/V_L$  is termed the expansion factor (or ratio) of a foam. A reformulation of the factor  $\rho_L/\rho_F$

yields the so-called increase of volume upon foaming, or foaming power, as  $100[(\rho_L/\rho_F) - 1]$ . Here the term in square brackets is the ratio of gas to liquid volume in the foam. The densities of quite stable foams can be measured by pycnometer, or by calculation from known volumes of initial liquid and final foam, from Eq. (2.33). In some cases conductivity measurements can be used. Foam densities typically vary from about 0.02 g/mL to about 0.5 g/mL [110]. However, it should be borne in mind that bulk foams are not necessarily homogeneous and usually exhibit a distribution of densities throughout the vertical direction due to gravity-induced drainage.

Foam characterization can also be accomplished by cryogenic electron microscopy, which essentially permits direct observation of the phases [70,71,73].

The structure and appearance of the so-called micro-foams, also termed colloidal gas aphrons, is somewhat different from conventional foams. Micro-foams consist



**Figure 2.16** Reconstructed images from a magnetic resonance imaging (MRI) slice through a nonaqueous (bitumen) foam. The images have been reconstructed to highlight the water droplets (a) and the gas bubbles (b). From Shaw *et. al.* [98]. Copyright 1994, American Chemical Society.

of very small foam bubbles created by dispersing gas into surfactant solution under conditions of very high shear such that very small gas bubbles are created, each surrounded by a bi-molecular film of stabilizing surfactant molecules [111–113]. See Section 8.3.

Foams can also contain dispersions (suspensions or emulsions) within their lamellae. Figure 1.5 shows an example of a foam containing emulsified oil droplets that are small enough to permit their passage inside the foam's lamellar structure [114]. As mentioned in Section 2.5.1, magnetic resonance imaging can be used to distinguish different chemical environments in which NMR-active nuclei find themselves, including oil versus water. This can be useful for opaque, non-aqueous foams and froths. Figure 2.16 shows NMR images of a non-aqueous (bitumen) foam. In this case, the images have been reconstructed to highlight the water droplets against the continuous oil phase (Figure 2.16a) and also the gas bubbles (Figure 2.16b).

### 2.6.2

#### Experimental Assessment of Foam Stability

Foam stability is usually tested by one of three methods [4,6,13]:

- the lifetime of single bubbles,
- the steady-state (dynamic) foam volume under given conditions of gas flow, shaking, or shearing, or,
- the rate of collapse of a (static) column of foam generated as above.

The first method is quite difficult to reproduce due to the strong influence on the results that small contaminations or vibrations can have. The latter two are also difficult to reproduce since the foam generation and collapse is not always uniform, yet these methods are very commonly used. The dynamic foam tests are most suitable for evanescent foams since their lifetimes are transient. For more stable foams the static foam tests are more commonly used.

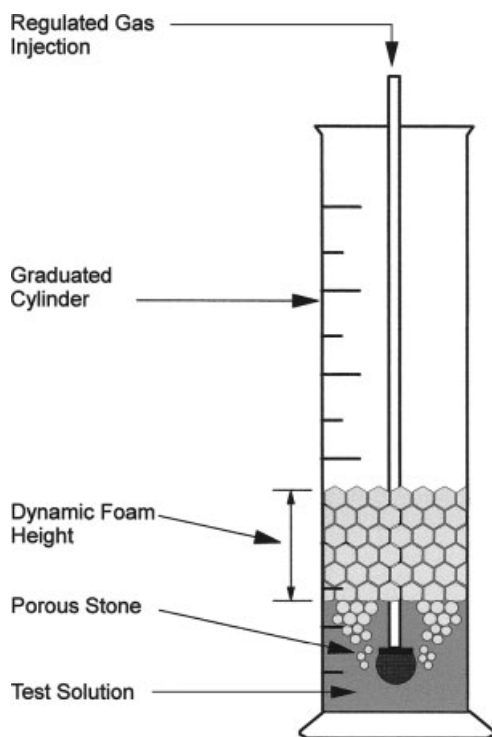
#### Dynamic Foam Test

Here, foam is generated by flowing gas through a porous orifice into a test solution as shown in Figure 2.17. The steady-state foam volume maintained under constant gas flow into the column is then measured. There are many variations of this kind of test [46,115,116]. This technique is frequently used to assess the stability of evanescent foams.

#### Static Foam Test

In the Ross-Miles static foam test, foam is usually generated by filling a pipet with a given volume of foaming solution, then allowing the solution to fall a specified distance into a separate volume of the same solution that is contained in a vessel (see Figure 2.18). The volume of foam that is produced immediately upon draining of the pipet (initial foam volume) is measured, as is the decay in foam volume by some elapsed time period. There are many variations of this test [117–122]. Some tests (like the Bartsch test) involve shaking a known volume of solution in a sealed con-



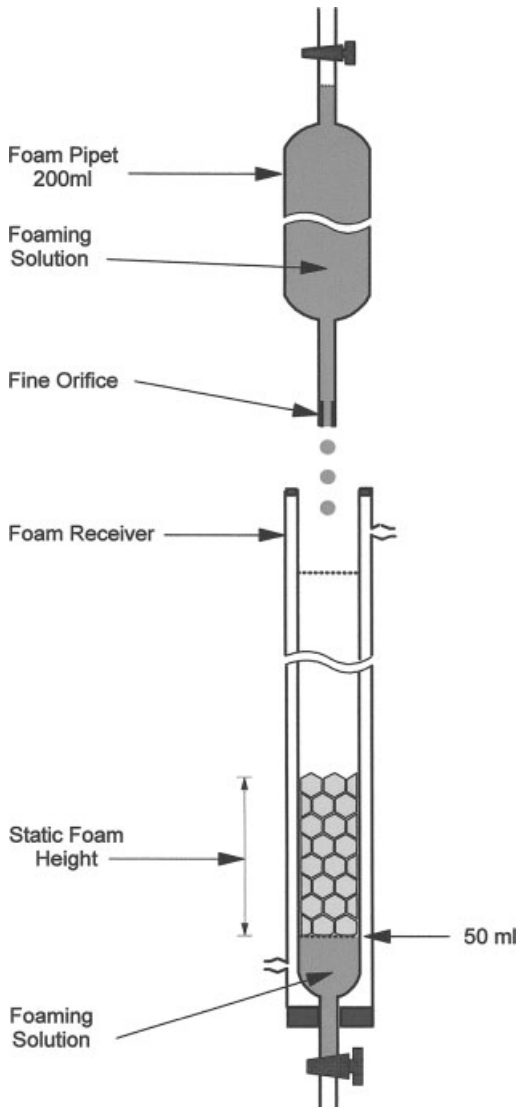


**Figure 2.17** Illustration of a dynamic foam stability test apparatus in which foam is generated by flowing gas through a porous diffuser. Not drawn to scale.

tainer, such as a bottle, to simulate conditions of relatively low shear [119,123]. Others involve blender dispersing to simulate conditions of high shear [120]. A variation of the static foam test for determining defoaming ability is described in Section 7.2.2.

In either the dynamic or static foam tests, but especially the static tests, one should bear in mind the many changes in a foam that may occur over time, including gas diffusion and changing bubble size distribution.

Other methods of determining foam stability include monitoring physical properties related to the foam. For example, several researchers discuss the use of NMR spectroscopic or MRI imaging monitoring of foam stability [109,124].



**Figure 2.18** Illustration of a static foam stability test apparatus in which foaming solution falls into a pool of the same solution in a volumetric receiver. Not drawn to scale.

## 2.7

### Characterization of Suspensions

#### 2.7.1

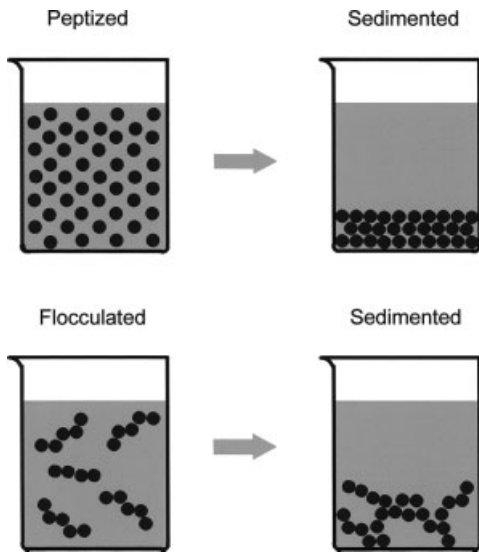
##### Chemical and Surface Analysis

Any classical wet-chemical analyses or instrumental techniques that are routinely used to analyze the bulk composition of solids and liquids are, in principle, also suitable for colloids. The available instrumental methods range, for example, from spectrographic analysis for chemical composition, which is limited to crude estimates for impurities, to Raman spectroscopic identification of chemical functionalities, which can be very accurate [125]. These techniques can also be used to analyze adsorbed layers if they can be quantitatively desorbed and collected for study. Surface-chemical analyses that cannot be conducted using conventional methods designed for bulk materials are usually accomplished by optical, diffraction, and spectroscopic techniques; these are often applied under conditions of an ultrahigh vacuum. The spectroscopies measure the responses of solid surfaces to beams of electrons, ions, neutral species, and photons [126]. Each spectroscopy has unique attributes [15], making it suitable for certain colloids, but unsuitable for others. Although too numerous to list here, descriptions and tabulations of surface techniques and their synonyms and acronyms are given in Refs. [10,15,127,128]. A wide range of kinds of information can be obtained including surface and adsorbed layer compositions, including heterogeneity; surface morphology, atom packing, and structure; and surface reactions and their kinetics. Advances in these fields continue at a significant rate [129].

#### 2.7.2

##### Experimental Assessment of Suspension Stability

Compared to emulsions and foams discussed above, assessment of the stability of suspensions is relatively straightforward in most cases. Bottle or centrifuge tests are commonly used. Samples of the suspension components, and the suspension stabilizer or destabilizer to be tested, if any, are mixed in bottles or centrifuge tubes in a specified way, then allowed to stand or centrifuged at a specified g-force level. After a defined period of time, the suspensions are examined. For this, a time-scale appropriate to the process under consideration has to be set. In the stabilizing of suspensions one looks for a stable, homogeneous suspension with no particle aggregation. In the aggregating of suspensions one may be looking for a particular kind of particle association and resultant sediment volume. For example, simple coagulation may produce a small volume of compact sediment whereas a complex flocculation may produce a voluminous, high liquid-content sediment (see Figure 2.19). In either case, if measurements and/or observations are made over time, the rate of sedimentation and rate of condensation of the sediment layer can also be determined. Following the settling test the bottle or centrifuge tube can be agitated again to check the ease of re-suspension.



**Figure 2.19** Illustration of sedimentation in a peptized (upper) suspension, which yields a dense close-packed sediment, versus sedimentation in a flocculated (lower) suspension, which yields a loose, more voluminous sediment.



## 3

## Interfacial Energetics

## 3.1

## Surface Area

In colloidal dispersions, a thin intermediate region or boundary, known as the interface, lies between the dispersed and continuous phases. Each of emulsions, foams, and suspensions represent colloidal systems in which interfacial properties are very important because droplets, bubbles, and particles can have very large interfacial areas.

**Example.** The ratio of surface or interfacial area to mass of material is termed the specific surface area of a substance,  $A_{sp}$ . Consider the specific surface area of two 1 g samples of silica spheres for which in sample #1 the spheres are 1mm diameter, in sample #2 they are 1  $\mu\text{m}$  diameter. The total mass of each is the same (density 2  $\text{g}/\text{cm}^3$ ) but they do not have the same amount of surface area. For  $n$  spheres of density  $\rho$  and radius  $R$  we have

$$\begin{aligned} A_{sp} &= [(\# \text{ particles})(\text{area/particle})] / [(\# \text{ particles})(\text{mass/particle})] \quad (3.1) \\ &= [n 4\pi R^2] / [n (4/3)\pi R^3 \rho] \\ &= 3/(\rho R) \end{aligned}$$

Sample #1 containing the 1mm diameter spheres has a specific surface area of  $A_{sp} = 3/(2 \times 0.05) = 0.0030 \text{ m}^2/\text{g}$  while sample #2 containing the 1  $\mu\text{m}$  diameter spheres has a specific surface area of  $A_{sp} = 3/(2 \times 0.5 \times 10^{-4}) = 3.0 \text{ m}^2/\text{g}$ . The sample of smaller particles has 1000 times more surface area.

The activity of biocatalysts, like colloidal silver, is directly proportional to the surface area of the metal. The geometric progression in surface area of silver particles that one obtains by taking a starting point of 1  $\text{cm}^3$  of silver and then reducing incrementally into smaller and smaller cubes, produces silver particles having a total surface area approaching six square kilometres:

Length of side of cube	Total surface area in sample
1.0 cm	6 $\text{cm}^2$
1.0 $\mu\text{m}$	6 $\text{m}^2$
1.0 nm	6 $\text{km}^2$ .

The clay minerals can have a very large specific surface area because their ratio of particle diameter to thickness can range from 10:1, to 250:1, depending upon the nature of the clay and its exchangeable ions [49].

As will be seen in the following section, even a modest interfacial energy per unit area can become a considerable total interfacial energy. There is more surface energy in a two-phase system when the dispersed phase is highly subdivided than there is when it is coarsely subdivided. This is why colloidal dispersions have unique properties, and why they so often can only be prepared by applying high shearing forces to break down larger particles, droplets or bubbles. Each interface has a certain free energy per unit area which has a great influence on the stability and structure of the colloidal dispersion, and which has a great influence in practical areas such as mineral flotation, detergency, and waterproofing.

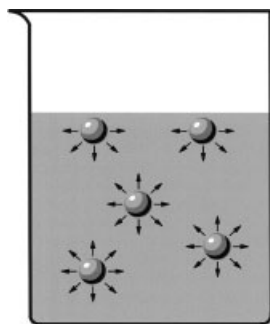
### 3.2

#### Surface and Interfacial Tensions

##### 3.2.1

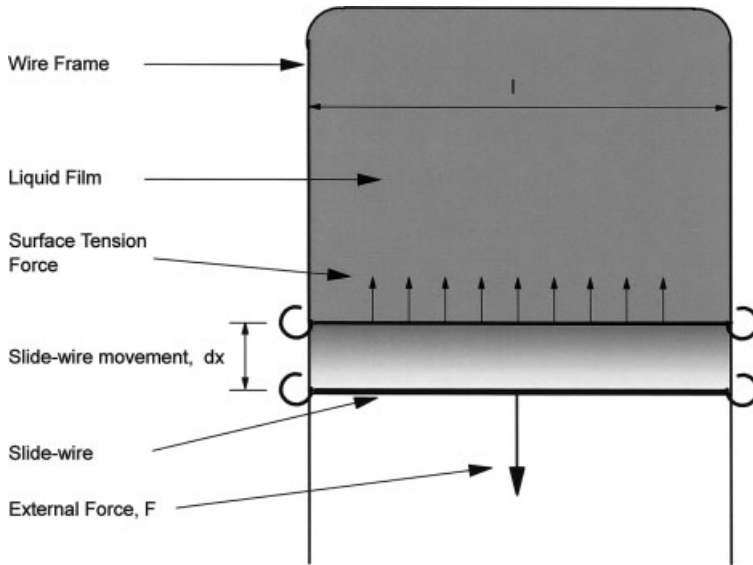
##### Principles

Consider the molecules in a liquid. As shown in Figure 3.1, for a liquid exposed to a gas the attractive van der Waals forces between molecules are felt equally by all molecules except those in the interfacial region. This imbalance pulls the latter molecules towards the interior of the liquid. The contracting force at the surface is known as the surface tension. Since the surface has a tendency to contract spontaneously in order to minimize the surface area, droplets of liquid and bubbles of gas tend to adopt a spherical shape: this reduces the total surface free energy. For two immiscible liquids a similar situation applies, except that it may not be so immediately obvious how the interface will tend to curve. There will still be an imbalance of intermolecular forces resulting in an interfacial tension and the interface will adopt a configuration that minimizes the interfacial free energy.



**Figure 3.1** Illustration of the attractive forces between molecules at the air/liquid interface, and in the interior of a bulk liquid.

Consider a liquid film constrained by a wire frame and moveable slide wire as shown in Figure 3.2. Assuming the entire system is frictionless, the surface tension



**Figure 3.2** Forces involved in stretching a thin liquid film, held in a wire frame, by pulling on one side via a slide-wire.

of the liquid will try to contract the film by pulling the slide-wire backward, unless countered by a force,  $F$ . The required countering force will act all along the length of the wire and varies with the length,  $l$ . This shows that the force along the length of the edge of the film is the intrinsic property of the surface of the liquid. Since the liquid film has two sides we can write  $\gamma = F/(2l)$  showing again that the surface tension has units of force per length,  $\text{mN/m}$  ( $1 \text{ mN/m} = 1 \text{ dyne/cm}$ ). Surface tension is the contracting force acting parallel to and around the perimeter of the surface or interface. The usual symbols for surface or interfacial tension are  $\gamma$  (or  $\sigma$ ). It is sometimes useful to think of surface tension as the two-dimensional analog of pressure.

Now consider the application of a small force greater than the equilibrium force just discussed. The extra force will cause the slide-wire to be displaced by an amount  $dx$ . The force times distance equals the energy spent increasing the area of the film by  $dA = 2l dx$ . Thus, the work done on the system is  $F dx = \gamma 2l dx = \gamma dA$ . So surface tension is also the work done per unit area to produce new surface area and has units reflecting that area expansion requires energy:  $\text{mJ/m}^2$  ( $1 \text{ mJ/m}^2 = 1 \text{ erg/cm}^2$ ). Work done on a system depends on how such work is done (i.e., it is path dependent). We can define the work done by the system as  $\delta w'$ , that is,  $\delta w' = -\gamma dA$ . Now a decrease in area equals work done by the system. The energy change is given by:

$$\begin{aligned}
 dE &= \text{heat absorbed} - \text{work done} \\
 &= \delta q - \delta w \\
 &= TdS \text{ (reversible)} - \{PdV + (-\gamma dA)\} \\
 &= TdS - PdV + \gamma dA
 \end{aligned}
 \tag{3.2}$$



remembering that  $dG = dE + PdV + VdP - TdS - SdT$ , we get

$$dG = TdS - PdV + \gamma dA + PdV + VdP - TdS - SdT = \gamma dA + VdP - SdT \quad (3.3)$$

so that for a reversible change at constant temperature and pressure:

$$\begin{aligned} dG &= \gamma dA \\ \text{or } \gamma &= (dG/dA)_{T,P} \end{aligned} \quad (3.4)$$

Thus surface or interfacial tension can also reflect the change in Gibbs free energy per area, consistent with the idea that area expansion requires energy.

It is sometimes useful to think of surface tension as a contracting force around the perimeter of a surface, and sometimes as surface free energy associated with area change. The units are equivalent: energy/area =  $\text{J}/\text{m}^2 = \text{Nm}/\text{m}^2 = \text{N}/\text{m}$ .

The lamellae in a foam contain two gas/liquid interfaces separated by a layer of fluid, thin film, each interface having a surface tension. For this reason the term film tension is sometimes used, the film tension being equal to twice the surface tension of the surfaces. It should be noted that, while the film tension is twice the surface tension of the surfaces, this is not necessarily the same as twice the surface tension of the bulk solution. In fact, the surface tension of a fluid film surface is similar to that of the bulk solution when the fluid film is thick, but departs from the bulk solution value as the fluid film thins. The situation is similar for the thin films between droplets in a concentrated emulsion.

Table 3.1 shows some values of surface and interfacial tensions. It can be seen, for example, that mercury has a greater cohesive energy than does water, which in turn greater than that of benzene. Thus:

$$\begin{aligned} \gamma_{\text{Hg}} &> \gamma_{\text{H}_2\text{O}} > \gamma_{\text{Bz}} \\ 484 &> 73 > 29 \text{ mN/m} \end{aligned}$$

Interfacial tensions are usually intermediate between the values of the surface tensions of the liquids involved. Interfacial tensions are smallest when the liquids are the most chemically similar (for pure liquids). For example, at 20 °C,

$$\gamma_{\text{Bz}} = 29.0 \text{ mN/m} \text{ and } \gamma_{\text{H}_2\text{O}} = 72.8 \text{ mN/m}$$

$$\gamma (\text{Bz}/\text{H}_2\text{O}) = 35.0 \text{ mN/m, and not } 1/2(29.0+72.8).$$

**Table 3.1** Some values of surface and interfacial tension\*.

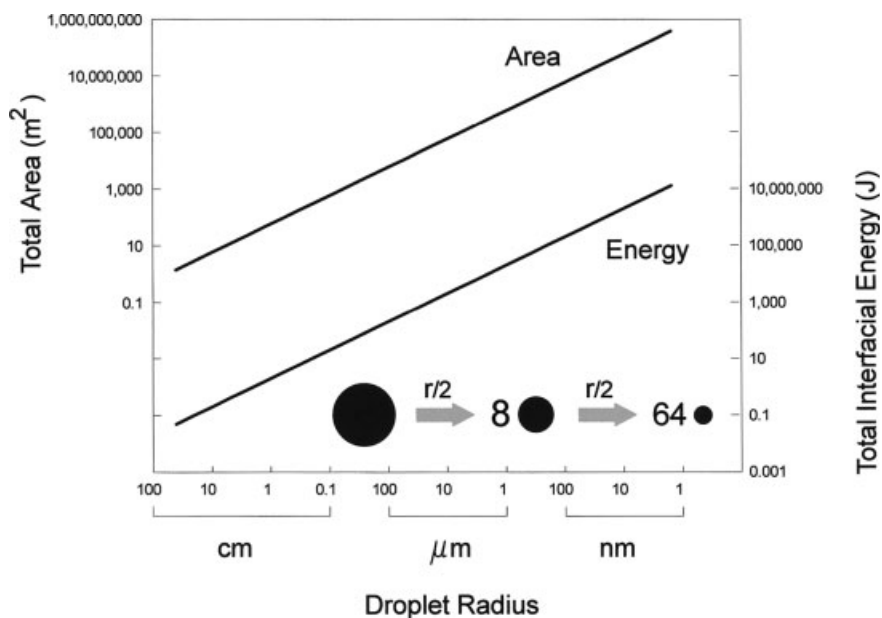
Fluid 1	Fluid 2	Temperature (°C)	Surface tension (mN/m)
Silver	Air	1100	878
Mercury	Air	20	484
Sodium nitrate	Air	308	117
Water	Air	20	73
Propylene carbonate	Air	20	41
Trinidad bitumen	Air	25	38
Benzene	Air	20	29
n-Octanol	Air	20	28
Propionic acid	Air	20	27
Engine oil (30W)	Air	20	26
n-Octane	Air	20	22
Ethyl ether	Air	20	17
Argon	Air	-183	11
Perfluoropentane	Air	20	10
Mercury	Water	20	415
Mercury	Benzene	20	357
n-Octane	Water	20	51
Benzene	Water	20	35
Methylene chloride	Water	20	28
Ethyl ether	Water	20	11
n-Octanol	Water	20	9
n-Butanol	Water	20	2

\* From a variety of sources. Values are approximate and intended only for illustration.

**Example.** An emulsion is a dispersion of one immiscible liquid in another. In most cases one of the liquids is aqueous and the other is in some sense, an oil. Emulsions are another kind of colloidal system in which interfacial properties are very important because emulsified droplets have a large interfacial area. Even a modest interfacial energy per unit area can become a considerable total interfacial energy to be reckoned with.

Suppose we wish to emulsify one barrel (159 L) of oil into water. For this illustration consider the oil to start off in one large drop, that we repeatedly subdivide into drops of half the previous radius. Thus, the initial drop of  $r = 33.6$  cm becomes eight drops of  $r = 16.8$  cm, and so on. Figure 3.3 shows that the total surface or interfacial area produced increases by a factor of 2 with each cut. The initial interfacial area of  $1.42 \text{ m}^2$  increases to  $7.4 \times 10^5 \text{ m}^2$  by the time we have produced droplets of  $0.64 \text{ }\mu\text{m}$  radius ( $1.2 \text{ }\mu\text{m}$  diameter). This is an increase of over five orders of magnitude!

The larger interfacial area will have a significant total free energy as is also shown in the figure. If the interfacial tension is  $35 \text{ mN/m}$ , then by the time the droplet size is  $r = 0.64 \text{ }\mu\text{m}$ , the total energy will have increased from  $0.05 \text{ J}$  to  $2.6 \times 10^4 \text{ J}$ . This  $26 \text{ kJ}$  of energy had to be added to the system to achieve the emulsification. If this amount of energy cannot be provided, say



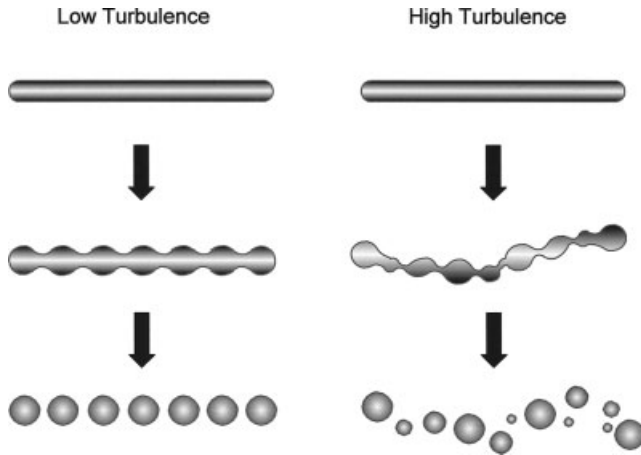
**Figure 3.3** Illustration of total area and energy changes involved in emulsifying 1 barrel of oil into water by dispersing into progressively finer droplets.

by mechanical shear, then another alternative is to use surfactant chemistry to lower the interfacial free energy, or interfacial tension.

The energy plotted in Figure 3.3 was obtained by multiplying the total area by the interfacial tension. Suppose now that a small quantity of a surfactant was added to the water, possibly a few tenths of a percent, that lowered the interfacial tension to 0.35 mN/m. This would lower the amount of mechanical energy needed in the above example by a factor of 100. From the area per molecule that the adsorbed emulsifying agent occupies, the minimum amount of emulsifier needed for the emulsion can also be estimated.

Of course, interfacial tension lowering alone may not be sufficient to stabilize an emulsion, in which case other interfacial properties must be adjusted as well. These simple calculations do, however, show how important the interfacial properties can become when colloidal-sized species are involved, as in the case of emulsions.

In practice, emulsification requires even more energy than that calculated in the above example, since deformation of large drops is needed before smaller drops can pinch off (Figure 3.4). In laminar flow this deformation is produced by viscous forces exerted by the surrounding liquid. If a stream of liquid is injected with low turbulence into another, immiscible liquid the cylindrical column of liquid will eventually become unstable and break up into droplets (Figure 3.4a). Under high turbulence the breakdown occurs sooner and produces smaller droplets (Figure



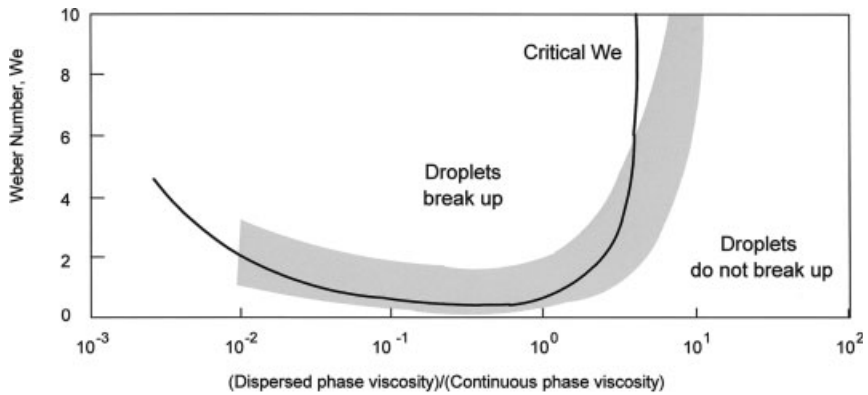
**Figure 3.4** Illustrations of the breakup of liquid streams injected into another liquid under low versus high degrees of turbulence.

3.4b). The energy needed to produce the required velocity gradient for deformation and pinch-off can be of the order of a thousand times the thermodynamic energy requirement discussed above. The excess energy is dissipated as heat.

The exact result is influenced by the viscosities of the two liquid phases, the amount of mechanical shear produced, and the interfacial tension, among others. One representation is given by the critical Weber number [130–132]. The Weber number,  $We$ , is given by:

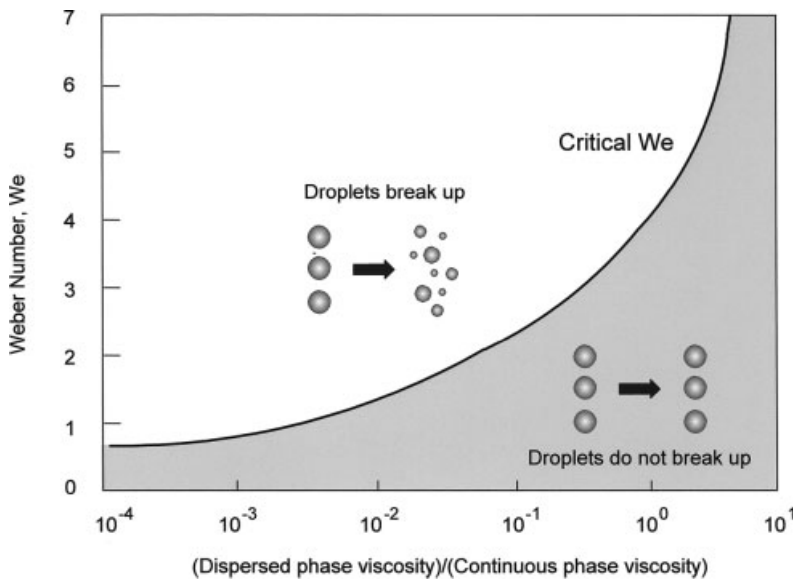
$$We = (\eta_1 \dot{\gamma} \cdot R) / \gamma_{12} \quad (3.5)$$

where  $\eta_1$  is the viscosity of the continuous phase,  $\dot{\gamma}$  is the shear rate,  $R$  is the droplet radius produced, and  $\gamma_{12}$  is the interfacial tension (the superscript 2 represents the dispersed phase). This also applies to the break-up of gas bubbles. The critical  $We$  value has to be exceeded in order for a droplet to be disrupted and burst. Depending on the viscosity ratio,  $\eta_2/\eta_1$ , between the dispersed ( $\eta_2$ ) and continuous ( $\eta_1$ ) phases,  $We$  can range from 0.5 to  $\infty$ , in laminar flow. For turbulent flow conditions the equation giving the droplet (or bubble) size is different, as reviewed by Walstra [131,132]. Figure 3.5 shows the critical Weber number as a function of viscosity ratio [131]. It can be seen that for a low continuous phase viscosity the deformation of droplets requires very high velocity gradients. For this reason turbulent flow is usually needed for emulsification into a low viscosity liquid. Also, if  $\eta_2/\eta_1 \geq 4$  then no droplet break-up occurs regardless of the  $We$  value.



**Figure 3.5** The critical Weber number for disruption of droplets in simple shear flow (solid curve), and for the resulting average droplet size in a colloid mill (hatched area) as a function of the viscosity ratio for disperse to continuous phases. Redrawn from data in Walstra [131].

Figure 3.6 shows that, for a given viscosity ratio,  $\eta_2/\eta_1$ , between the dispersed ( $\eta_2$ ) and continuous ( $\eta_1$ ) phases, reducing the interfacial tension increases the Weber number, lowering the energy needed to cause droplet break-up. As discussed in Section 11.2.1, this relationship can be used to predict whether an emulsion will be easier to form if it is a water-in-oil emulsion rather than an oil-in-water emulsion.



**Figure 3.6** Droplet breakup as a function of viscosity ratio. The solid line represents the critical Weber number value above which droplet breakup will occur. Data from Isaacs and Chow [130].

The same considerations apply to the making of a foam by dispersion of gas bubbles into water, assuming constant gas volume fraction. When dispersing particles by subdivision energy is still required, but the situation is somewhat different in that particles fracture rather than deforming and pinching off, as is the case with droplets and bubbles.

### 3.2.2

#### Equation of Young–Laplace

Interfacial tension causes a pressure difference to exist across a curved surface, the pressure being greater on the concave side (i.e., on the inside of a droplet or bubble). Consider an interface between phase A, in a droplet or bubble, and phase B, surrounding the droplet or bubble. These will have pressures  $p_A$  and  $p_B$ . If the principal radii of curvature are  $R_1$  and  $R_2$  then,

$$\Delta p = p_A - p_B = \gamma \left( \frac{1}{R_1} + \frac{1}{R_2} \right) \quad (3.6)$$

This is the Young–Laplace equation. For spherical droplets or bubbles of radius  $R$  in a dilute emulsion or foam,

$$\Delta p = p_A - p_B = 2 \gamma / R \quad (3.7)$$

so that  $\Delta p$  varies with the radius,  $R$ . The Young–Laplace equation shows that  $p_A > p_B$ , the pressure inside a droplet or bubble exceeds that outside.

The Young–Laplace equation forms the basis for some important methods for measuring surface and interfacial tensions, such as the pendant and sessile drop methods, the spinning drop method, and the maximum bubble pressure method (see Section 3.2.3). Liquid flow in response to the pressure difference expressed by Eqs. (3.6) or (3.7) is known as Laplace flow, or capillary flow.

**Example.** In primary oil recovery from underground reservoirs the capillary forces described by this equation are responsible for holding back much of the oil (residual oil) in parts of the pore structure in the rock or sand. It is these same forces that any secondary or enhanced (tertiary) oil recovery process strategies are intended to overcome [133]. Section 11.2.2 describes the use of the Young–Laplace equation to demonstrate how lowering interfacial tension and/or contact angle can be used to change the liquid saturations and increase oil recovery [2,133]. In this case,  $r$ , the pore radius, is used in place of  $R$  in the Young–Laplace equation.

### 3.2.3

#### Measurement

There are many methods available for the measurement of surface and interfacial tensions [134–138], see Table 3.2. A number of the most common are introduced in this section.

**Table 3.2** Classification of Methods

Method	Static	Dynamic	$\gamma^\circ$	$\gamma$	$\theta$	Remarks
Capillary rise	✓	≈	✓	X	X	need $\theta=0$
Wilhelmy plate	✓	≈	✓	X	X	need $\theta=0$
du Noüy ring	✓	X	✓	X	X	pure liquids
Drop weight	✓	X	✓	✓	X	need $\theta=0$
Drop volume	✓	X	✓	✓	X	need $\theta=0$
Pendant drop	✓	✓	✓	✓	X	
Sessile drop	✓	✓	✓	✓	✓	
Oscillating jet	✓	✓	✓	X	X	
Spinning drop	✓	≈	✓	✓	X	
Maximum bubble pressure	✓	≈	✓	X	X	
Maximum droplet pressure	✓	≈	✓	✓	X	
Tilting plate	✓	≈	X	X	✓	

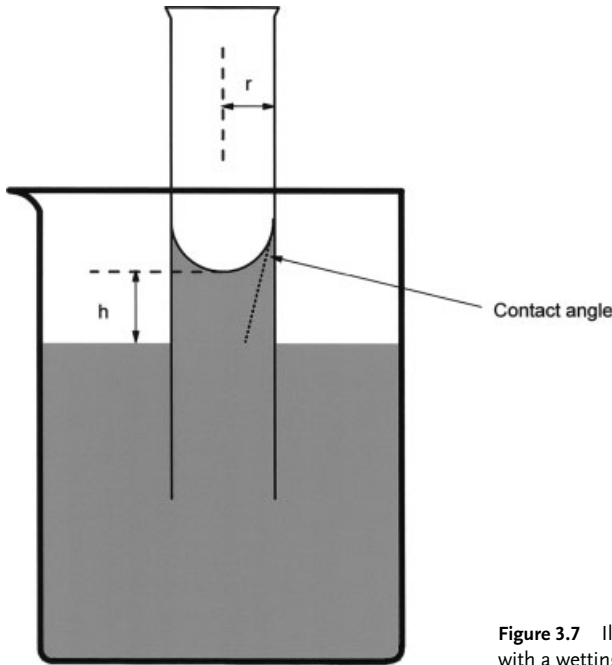
For emulsions, the interfacial tension is usually of most interest. Here, the du Noüy ring, Wilhelmy plate, drop volume, pendant, or sessile drop methods are the most commonly used. The spinning drop or captive drop techniques are applicable to the very low interfacial tensions encountered in the enhanced oil recovery and microemulsion fields. The maximum droplet pressure technique can be used when there is little or no density contrast between the phases, such as in bitumen–water systems at elevated temperature.

For foams, it is the surface tension of the foaming solution that is usually of most interest. For this, the most commonly used methods are the du Noüy ring, Wilhelmy plate, drop weight or volume, pendant drop, and the maximum bubble pressure method. For suspensions it is again usually the surface tension of the continuous phase that is of most interest, with the same methods being used in most cases. Some work has also been done on the surface tension of the overall suspension itself using, for example, the du Noüy ring and maximum bubble pressure methods (see Section 3.2.4).

Compared with other surface and interfacial properties, surface and interfacial tensions have not received much attention in the area of suspensions. In fact it is quite common in industrial practice, when dealing with such systems, to remove the solids and measure and report surface and interfacial tensions on a solids-free basis. This is in spite of the fact that it may be the properties of the suspensions proper that are important. For example, dispersed fine solids can themselves influence surface and interfacial tensions [139].

### Capillary Rise

The capillary rise method is a classical method for determining surface tension that has important applications. For capillary rise in a narrow capillary (Figure 3.7) a force balance yields:



**Figure 3.7** Illustration of capillary rise with a wetting contact angle.

$$(\text{Perimeter})\gamma\cos\theta \approx mg$$

$$2\pi r\gamma\cos\theta \approx \pi r^2 h \Delta\rho g$$

$$\gamma \approx (rh\Delta\rho g)/(2\cos\theta) \quad (3.8)$$

For zero contact angle  $\gamma \approx 1/2 rh\Delta\rho g$ . However, this still ignores the weight of the crown of the meniscus. For a hemispherical meniscus

$$\gamma = 1/2r (h + (r/3)) \Delta\rho g. \quad (3.9)$$

This method requires  $\theta = 0$  (otherwise we would have to measure  $\theta$  which is difficult in this case), and a uniform bore capillary. An advantage is that, since no disturbance of the surface is involved, slow time-dependent effects can be observed.

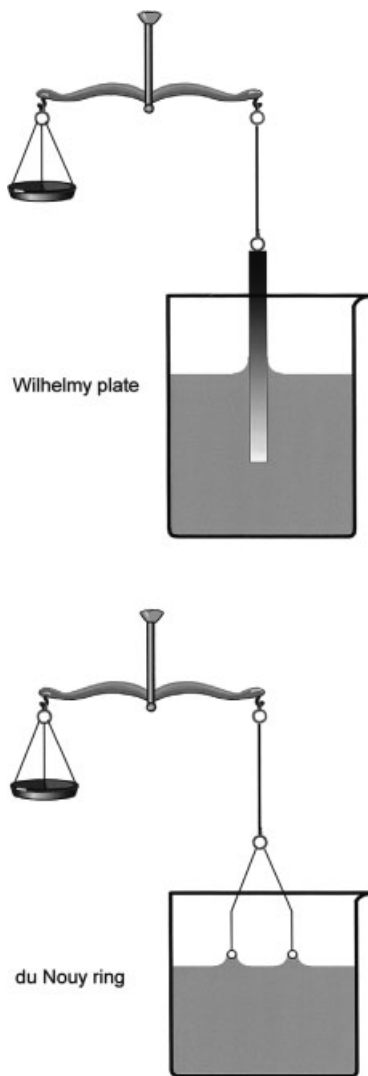
The force balance just described has an important application in the recovery of crude oil from underground reservoirs, as discussed in Section 11.2.2.

### Wilhelmy Plate

In the classical method one slowly lowers a container of liquid with respect to a thin solid plate of mica or glass (Figure 3.8, Upper). The weight  $W_{\text{det}}$  on a balance arm at the point of detachment is measured. For a plate of weight  $W$  and dimensions  $x, y$ :

$$W_{\text{det}} - W = 2(x+y) \gamma \quad (3.10)$$





**Figure 3.8** Illustrations of the Wilhelmy plate (upper) and du Nouy ring (lower) surface tension methods. Both illustrations are for wetting contact angles.

This method also requires that  $\theta=0$ . A variation on the method eliminates the detachment step. Here one holds the plate at the point where the bottom of the plate is in the plane of the liquid surface. At this point the surface tension holds up the weight of the meniscus, using the perimeter of the plate ( $p$ ):

$$W_{\text{meas}} - W = p \gamma \cos \theta. \quad (3.11)$$

Here two parameters are involved,  $\theta$  and  $\gamma$ , and one is required to be measured independently unless  $\theta=0$ .

**Du Noüy Ring**

The du Noüy ring surface tension method involves slowly raising a platinum ring through a liquid until it detaches from the surface (Figure 3.8, Lower). The force at the point of detachment is measured using a balance or torsion wire. If  $F$  is the force on the ring,

$$2(2\pi r) \gamma \cos \theta \approx \beta F, \text{ for } \theta = 0:$$

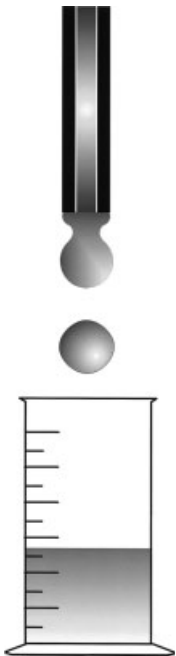
$$\gamma = \beta F / (4\pi r) \quad (3.12)$$

Here  $\beta$  is a correction factor to allow for the complex shape of the liquid just before break-away and for the non-vertical surface tension forces. Tabulations of  $\beta$  are given in the literature. Again zero contact angle is required (attainable with an extremely clean ring) and the ring must lie flat on a quiescent liquid surface. For interfacial tension measurements the ring must be preferentially wetted by the lower liquid.

**Drop Weight and Volume Methods**

In these methods drops of liquid are allowed to detach slowly from the tip of a vertical capillary and either weighed or their volume measured (Figure 3.9). For mass  $m$ , volume  $V$ , and density  $\rho$ :

$$\gamma = \phi mg / (2\pi r) = \phi V \rho g / (2\pi r) \quad (3.13)$$

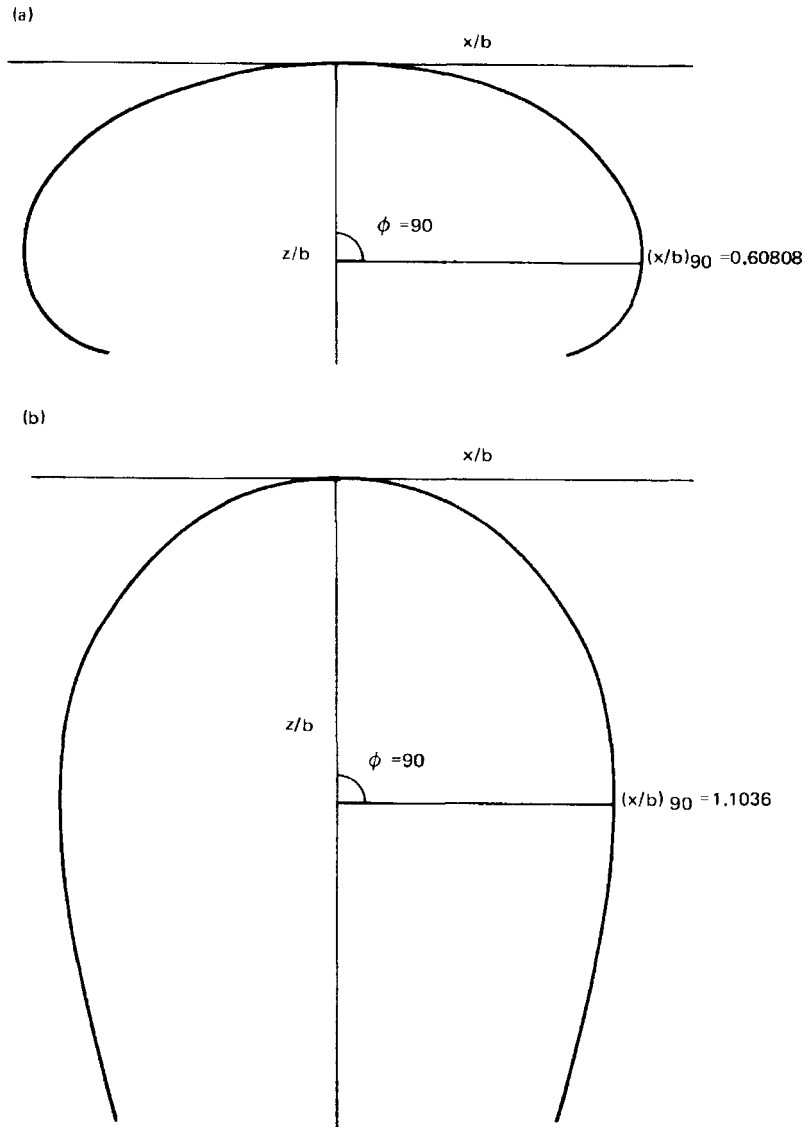


**Figure 3.9** Illustration of the drop weight/volume surface tension method (shown here for a wetting contact angle).

Here  $\phi$  is a correction factor to account for the facts that the drops do not completely leave the tip, and that the surface tension forces are not truly vertical. Values of  $\phi$  are reported in the literature. For this method the tip must be completely wetted and the drops must form and detach slowly ( $> 1$  min/drop).

### Drop Shape Methods

The pendant drop method and the sessile drop methods for surface tension appear quite different, but are similar in principle. In each case a drop is formed which either sits on a plane surface (sessile, see Figure 3.10) or hangs as a pendant drop



**Figure 3.10** Illustration of sessile drop profiles. From Hiemenz [87]. Copyright 1986, Dekker.

(each can be formed rightside-up or upside-down depending on  $\Delta\rho$ . In zero gravity each would form a sphere due to surface or interfacial tension. In the gravitational field the drop becomes distorted until the gravitational and surface tension forces are equal.

For any figure of revolution  $R_1 = R_2$  at the apex, where the radius of curvature is, say,  $b$ . If the elevation of any point on the surface is  $z$  then  $\Delta P = \gamma(1/R_1 + 1/R_2)$  becomes:

$$\gamma(1/R_1 + 1/R_2) = \Delta\rho gz + 2\gamma/b \quad (3.14)$$

(At  $z=0$   $\Delta P = 2\gamma/b$ .) Defining  $\beta = \Delta\rho gb^2/\gamma^\circ$  and substituting into the Young–Laplace equation yields one form of the Bashforth–Adams equation:

$$2 + (\beta z/b) = (1/\{R_1/b\}) + (\sin \phi/\{x/b\}) \quad (3.15)$$

where  $\beta$  is positive for pendant drops and negative for sessile drops. This equation was solved numerically by Bashforth and Adams who have provided tables that can be used to solve the equation using successive approximations (see Adamson [15] for examples).

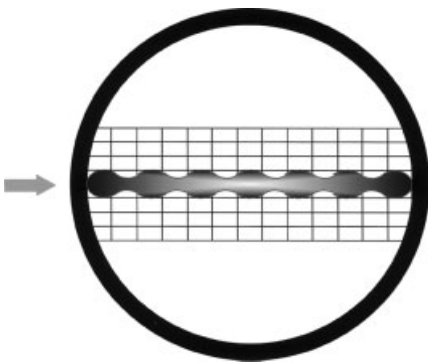
The sessile drop method can also be used for the determination of contact angle (Section 3.4).

The captive drop and captive bubble methods, variations of the sessile drop method, have been developed for the determination of very low values of surface or interfacial tension [140,141], including at elevated temperature and pressure [141].

### Oscillating Jet Method

If a jet of liquid is created using a nozzle of elliptical cross-section, changes in shape of the jet occur (Figure 3.11). This is because the elliptical shape is unstable and the jet will oscillate in shape (due to momentum) about the preferred shape, which is circular due to surface tension. The surface tension can be calculated from the wavelength of the oscillations, knowing the jet dimensions and flow rate, etc.

This is a dynamic method and can be used to measure  $\gamma$  from first instants of formation up to greater surface “ages” depending on the flow rate.



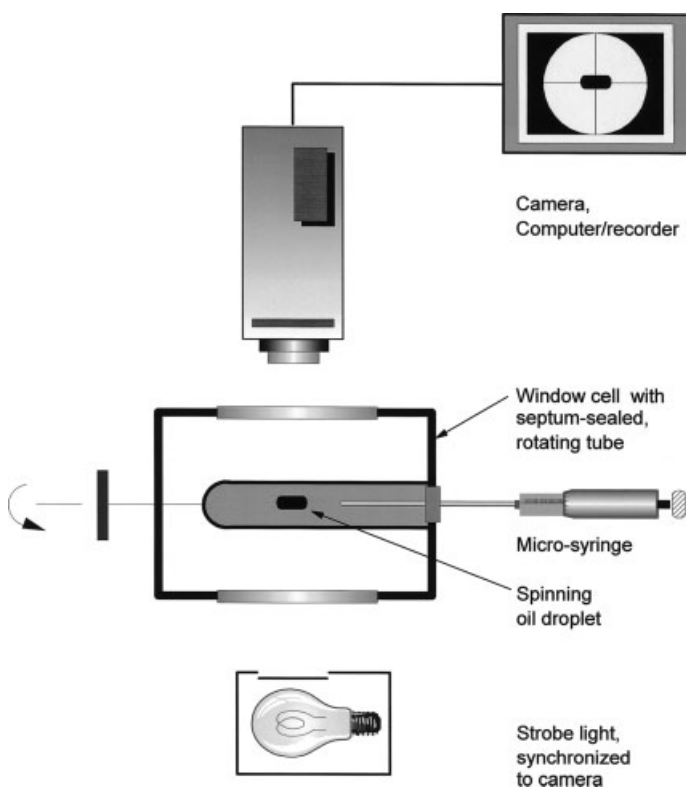
**Figure 3.11** Illustration of a magnified image of an oscillating jet of liquid that is being injected in front of a grid for measuring the jet's period. This is the oscillating jet method for surface tension measurement.

**Spinning Drop Method**

Also called the rotating drop method, this technique sets up a balance between centrifugal and surface tension forces. A small bubble or drop (ca. 0.2 mL) is placed in a liquid of greater density in a long transparent tube which is rotated rapidly (Figure 3.12). The bubble (for surface tension) elongates to an extent that depends on the surface tension, density difference and rotational speed. At high enough rotational speeds ( $\omega$ ) the central part of the bubble becomes cylindrical with radius  $r_c$  and if  $r_c < 1/4$  the drop length, then,

$$\gamma = \omega^2 \Delta \rho r_c^3 / 4 \quad (3.16)$$

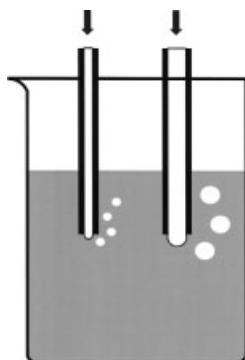
There is an upper limit to the values of  $\gamma$  that can be measured that is determined by the upper limit of rotational speeds available to elongate the drop or bubble. See Refs. [138,142].



**Figure 3.12** Illustration of a spinning drop apparatus (the syringe is removed after placing the drop in the spinning tube).

### Maximum Bubble or Droplet Pressure Method

One can measure the maximum pressure that can be applied to a gas bubble at the end of a vertical capillary, of radius  $r$  and depth  $t$  in a liquid, before it breaks away (Figure 3.13) [143]. Before break-away the bubble has the shape of a sessile drop and is described by the equation of Bashforth and Adams. The pressure in the tube is the sum of the hydrostatic pressure ( $\Delta\rho g t$ ) and the pressure due to surface tension. Equations have been published which allow calculation of surface tension using Bashforth–Adams and density and depth data.



**Figure 3.13** Illustration of the maximum bubble pressure method using two capillary tubes.

A better method uses two capillaries of differing radius, at the same immersion depth, and involves measuring the differential maximum bubble pressure between the two capillaries. In this case the two ( $\Delta\rho g t$ ) terms cancel out and the differential pressure is the difference between the two ( $2\gamma/b$ ) terms where  $b$  is the radius of curvature at the apex of the bubble.

A variation of this technique, the maximum droplet pressure method, can be used to determine interfacial tensions. This technique is especially useful in situations for which the density contrast between the two liquid phases is very low, or non-existent [144,145].

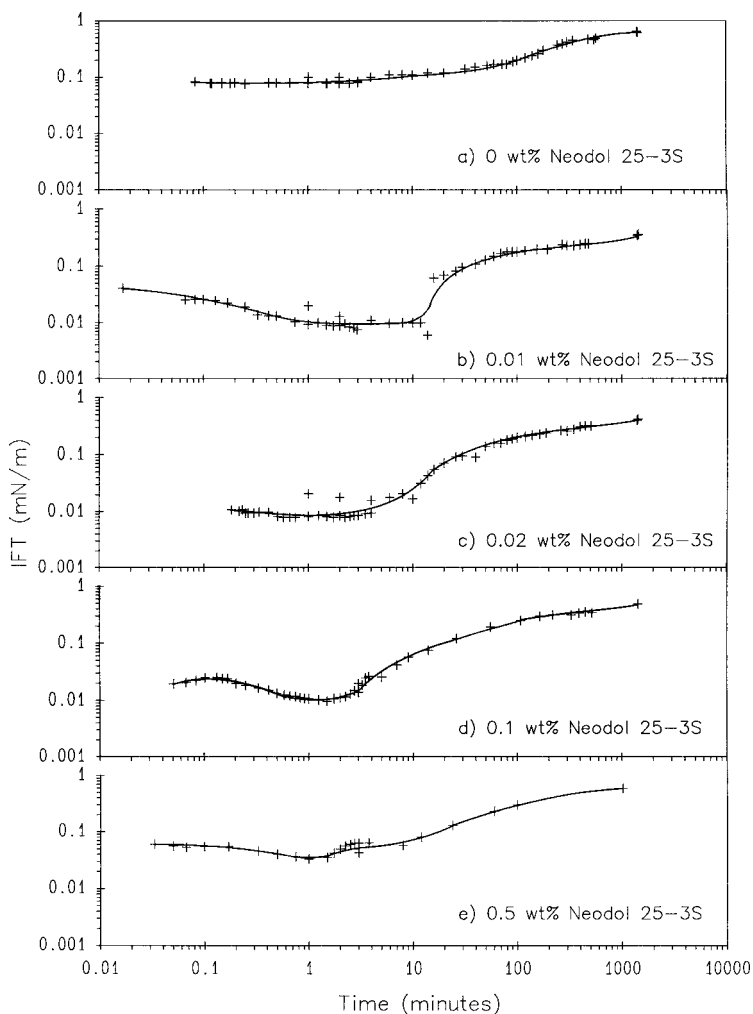
Extreme cleanliness of all surfaces and interfaces is required in all surface and interfacial tension methods. This is also required to achieve the condition  $\theta=0$  that some of the methods require. For most of the methods the apparatus must be absolutely vibration-free. In all of the methods the temperature must be carefully controlled. In the methods where densities are needed, these must be accurately known.

In all cases it should be appreciated that, when solutions rather than pure liquids are involved, there can be appreciable changes taking place with time at the surfaces and interfaces. Many of the methods which involve making new surfaces or interfaces are difficult or impossible to apply accurately to solutions. Also, where interfacial tensions are desired the second liquid competes with the first for attachment to whatever solid support is involved in the measurement method. This can cause hysteresis, and metastable menisci can result (e.g., in du Noüy, Wilhelmy and capillary methods).

## 3.2.4

**Experimental Results for Dispersions**

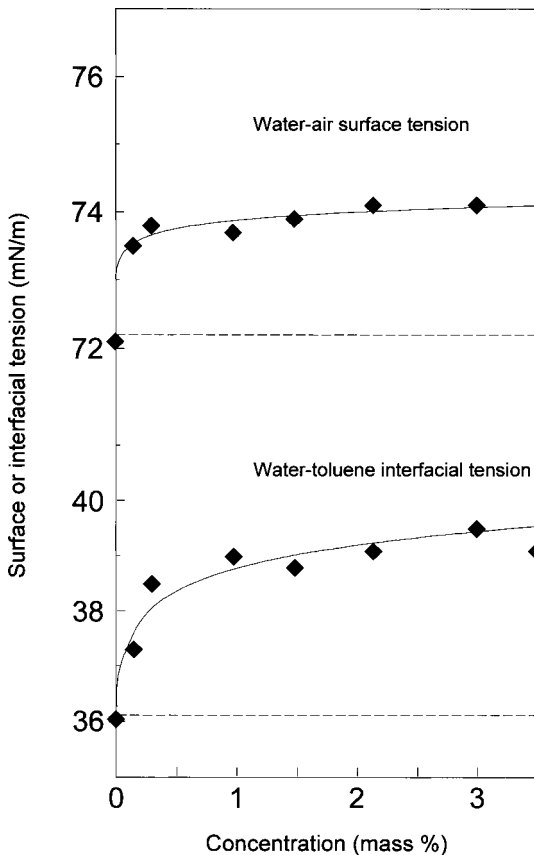
Several generic kinds of results are pertinent to the properties of dispersions. The surfactant solutions formulated to stabilize microemulsions, and some kinds of macroemulsions, can exhibit marked dynamic interfacial tension behaviour. Figure 3.14 shows an example in which a series of commercial surfactant additions are made to a system containing crude oil and a base. Under alkaline conditions the interfacial tension is already dynamic due to the saponification of natural surfac-



**Figure 3.14** Example of some dynamic interfacial tensions in a system containing crude oil, 1 mass%  $\text{Na}_2\text{CO}_3$ , 0.5 mass%  $\text{NaCl}$ , and varying concentrations of a commercial surfactant (Neodol 25-3S). From Taylor and Schramm [142]. Copyright 1990, Elsevier.

tants from the crude oil. With the additions of the synthetic surfactant, several diffusion and competitive adsorption/desorption reactions occur simultaneously, leading to dynamic interfacial tensions spanning several orders of magnitude. In addition to the effect this has on processes for which the interfacial tension is important (see, for example, Section 11.2.2) this directly changes the interfacial elasticity which has an influence on emulsion formation and sometimes on emulsion stability. Surface elasticity is also very important to the formation and stability of foams. See the discussion in Section 3.5.4.

Several researchers have found that suspensions of charged particles, especially clays, can have surface tensions that are several mN/m greater than that of pure water [139,146–148]. In much the same way as for solutions of inorganic electrolytes, the increased surface tension is probably due to strong interactions between water molecules and the ionic solutes. Figure 3.15 shows some examples, including



**Figure 3.15** Suspension-air and suspension-toluene surface and interfacial tensions for aqueous suspensions of Na-montmorillonite. The broken lines show the values measured for pure water. From data reported in Schramm and Hepler [139].



an illustration of how dispersed montmorillonite can also increase the suspension–toluene interfacial tension compared with that of pure water–toluene. This has application in areas such as ceramic casting slips, which typically consist of suspensions of kaolinite in water in the presence of deflocculating agents [146,147]. Compared with the effect on surface tension of aqueous solutions of inorganic electrolytes, the effect of the presence of clay particles and their counter-ions can be of much greater magnitude than would be expected based on the addition of the same number of equivalents of the clay-counter-ions with simple anions [139]. The available literature suggests that high charge density particles such as montmorillonite can cause surface or interfacial tension elevation while low charge density particles such as kaolinite may have no significant effect or may cause surface or interfacial tension lowering. This is consistent with the results of Menon *et al.* [149–151], who found that the presence of fine solids at an oil–water interface could either raise or lower interfacial tensions, and explained their results in terms of different degrees of repulsive interaction among particles present at the interface. High interfacial coverages with charged shale dust particles were found to raise interfacial tension, but when the negative charge of the clays was almost completely countered by the adsorption of asphaltenes, interfacial tension lowering was observed. The possible effect of particle size on the surface or interfacial tensions of suspensions does not seem to have been studied.

### 3.3

#### Pressure and Curved Surfaces

The Young–Laplace equation (3.4/3.5) shows that,  $p_A > p_B$ , the pressure inside a bubble or drop exceeds that outside. For a sphere,  $\Delta p = p_A - p_B = 2\gamma/R$ , so that  $\Delta p$  varies with the radius,  $R$ . Thus the vapour pressure of a drop should be higher, the smaller the drop. This is shown by a related equation, the Kelvin equation [13,26], which is described here.

Consider the transfer of molecules from a bulk phase, having a huge flat surface, to a small spherical drop. There is no pressure difference across the large flat surface (zero curvature) and the pressure is just the vapour pressure  $p_0$ . According to the Young–Laplace equation there will be a difference in pressure across the sphere. Thus for liquid–vapour equilibrium at the spherical surface both liquid and vapour must be brought to the same pressure,  $p_0 + \Delta p$ . For an ideal vapour and incompressible liquid,  $\Delta G$  for increasing the pressure, is given for the liquid by:

$$\Delta G = \int_{p_0}^{p_0 + \Delta p} V_L dp = V_L \Delta p = 2V_L \gamma / r \quad (3.17)$$

where  $r$  is the sphere radius and  $V_L$  is the molar volume of the liquid.  $\Delta G$  for increasing the pressure is given for the gas by:

$$\Delta G = RT \ln\{(p_0 + \Delta p)/p_0\} = RT \ln(p/p_0) \quad (3.18)$$

For liquid and vapour in equilibrium, these values of  $\Delta G$  are equal and:

$$RT \ln(p/p_0) = 2V_L\gamma/r = 2M\gamma/(\rho r) \quad (3.19)$$

where the molar volume  $V_L = M/\rho$ . This is the Kelvin equation, which shows the pressure above a spherical surface of given radius and surface tension. It shows, for example, that for droplets in vapour, larger droplets will grow at the expense of smaller droplets.

The Kelvin equation can be applied to the solubility of spherical particles by replacing the ratio  $p/p_0$  by  $a/a_0$  where  $a_0$  is the activity of dissolved solute in equilibrium with a large flat surface and  $a$  is the activity in equilibrium with a small spherical surface. If we consider an ionic solute of formula  $M_mX_n$ , the activity of a dilute solution is related to the molar solubility  $S$  by:

$$2M\gamma/(\rho r) = RT \ln(a/a_0) = (m+n) RT \ln(S/S_0) \quad (3.20)$$

where  $S$  and  $S_0$  are the solubilities of the spherical and flat surfaces. Thus the Kelvin equation describes a number of supersaturation phenomena including supercooled vapours and supersaturated solutions.

### 3.4

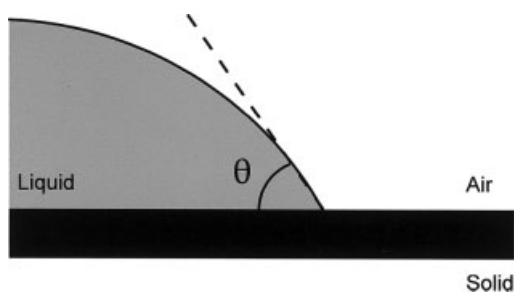
#### Contact Angle and Wettability

When a drop of liquid is placed on a solid surface the liquid may form a bead on the surface, or it may spread to form a film. A liquid having a strong affinity for the solid, i.e., if its surface tension is less than the critical surface tension of the surface,  $\gamma_c$ , will seek to maximize its contact (interfacial area) and spread to form a film. A liquid with much weaker affinity, i.e., if its surface tension is above  $\gamma_c$ , will form into a bead. The critical surface tensions of solids range from 18 mN/m for Teflon<sup>®</sup> to about 46 mN/m for nylon.

The affinity is termed the wettability [15,25,152]. To account for degrees of spreading, the contact angle,  $\theta$ , is defined as the angle, measured through the liquid, that is formed at the junction of three phases, e.g., at the S-L-G junction (Figure 3.16). Whereas interfacial tension is defined for the boundary between two phases, contact angle is defined for a three-phase junction. If the interfacial forces acting along the perimeter of the drop are represented by the interfacial tensions, then an equilibrium force balance is given by Young's equation as,

$$\gamma_{L/G} \cos \theta = \gamma_{S/G} - \gamma_{S/L} \quad (3.21)$$

The solid is completely wetted if  $\theta = 0$  and only partially wetted otherwise. Several practical points should be noted. Although in theory complete non-wetting would be  $\theta = 180^\circ$ , but values larger than about  $140^\circ$  are not actually seen in practice. Values of  $\theta > 90^\circ$  are often considered to represent "non-wetting" whereas values of  $\theta < 90^\circ$  are



**Figure 3.16** The contact angle, illustrated here as the angle measured through the liquid, that is formed at the junction of solid, liquid, and gas (air) phases.

often considered to represent “wetting”. This rather arbitrary assignment is based on correlation with the visual appearance of drops on surfaces. The wetting of irregular or rough surfaces is, of course, more complicated and is introduced in some detail by Morrison and Ross [76].

Two common methods for measuring contact angles are the sessile drop and tilting plate methods.

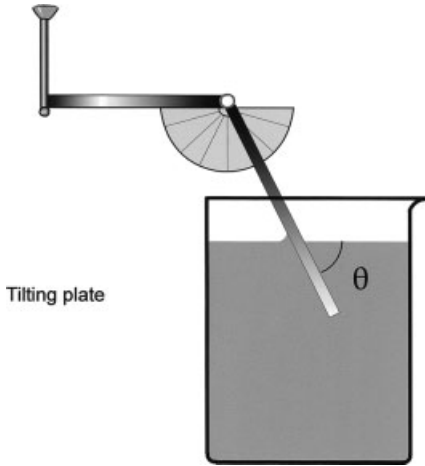
#### **Sessile Drop Method**

The sessile drop method, described in Section 3.2.3, can also be used for the determination of contact angle. A sessile drop is created as for surface tension measurement, but instead of measuring drop shape, the contact angle ( $\theta$ ) is measured through the liquid phase (Figure 3.16). This can be done using a goniometer.

#### **Tilting Plate Method**

In this method the angle of a plate immersed in a liquid is adjusted until the bulk liquid surface remains exactly flat right up to the solid surface (Figure 3.17). At this point the contact angle between the liquid and solid surfaces can be measured directly. For this the solid surface must be highly polished and free of impurities. Contact angle hysteresis can be a problem: there can sometimes be a significant difference (up to  $50^\circ$ ) between advancing and receding contact angles.

The most commonly used is the sessile drop method, and most of the available literature data are for smooth, macroscopic, solid surfaces. Some special problems arise when one is interested in the wettability of finely divided solids. The small size of the particles makes measurement difficult, but more importantly, surface roughness and particle shape can have a significant effect on the contact angle. One approach that has been used is to compress the particles into a porous plug, measure the capillary pressure and then calculate the contact angle. This approach suffers from uncertainties due to particle packing, surface roughness, shape, and porosity effects [153]. Another approach is to estimate the surface tension of the particles based on a thermodynamic model, such as is used in the advancing solidification front, or freezing front, technique [154].



**Figure 3.17** Illustration of the tilting plate method for measuring contact angle.

It is also possible to set up tests in which one simply observes the wetting behaviour of fine particles in different situations. For example, Mikula and Munoz [68] describe an advancing front technique in which a microscope is used to observe the behaviour of particles as they encounter an advancing liquid front. Particles that are water wettable would be engulfed by an advancing water front, while hydrophobic particles would be pushed ahead by it. This has been used to evaluate the effectiveness of wettability-altering agents (including demulsifiers) on the particles. A more quantitative approach is via the hydrophobic index, which is an empirical measure of the relative wetting preference of very small solid particles. In one such test method, solid particles of narrow size range are placed on the surfaces of a number of samples of water containing increasing concentrations of alcohol (thus providing a range of solvent surface tensions). The percentage alcohol solution at which the particles just begin to become hydrophilic and sink is taken as the hydrophobic index. The corresponding solvent surface-tension value is taken as the critical surface tension of wetting. The technique is also referred to as the film-flotation technique [155,156] or sink-float method.

In the case of porous media, which are important in such fields as oil and gas recovery, soil remediation and catalysis, wettability determination requires somewhat different methods such as those based on the imbibition of liquids [157–159]:

- **Amott–Harvey Indices**, in which spontaneous imbibition of, individually, water and oil compared with the maxima possible under forced (pressure) imbibition. These are used to calculate water (WI) and oil (OI) indices reflecting degrees of wettability between neutral and strongly wetting.
- **Wettability Index (W)**, (based on the U.S. Bureau of Mines wettability test), in which the forced (pressure) imbibition of water is compared to forced imbibition of oil via capillary pressure curves. The wettability index varies from  $-\infty$  for complete oil-wetting, to zero for neutral, to  $+\infty$  for complete water-wetting. For practical purposes, W usually varies between about  $-1.5$  and  $+1.0$ .

There are other variations of these imbibition methods, plus somewhat more direct methods such as cryomicroscopy (to visualize the distribution of liquids within the pores), and NMR (which is based on the different proton relaxation rates that occur for water near oil-wet versus water-wet surfaces).

An example of the importance of the wettability of fine particles is provided by what are called Pickering emulsions, that is, emulsions stabilized by a film of fine particles. The particles can be quite close-packed and the stabilizing film between droplets can be quite rigid, providing a strong mechanical barrier to coalescence. See Section 5.4.1.

When considering problems in sedimentation, it is usually assumed that particles are completely immersed in the surrounding liquid and therefore capable of sedimentation. But if dry particles are placed onto the surface of a body of liquid they may not settle even though their density is greater than that of the liquid. The explanation provides an example of the actions of surface tension and contact angle. For a solid particle to float on a liquid surface, the upward pull of the meniscus around it (reflected in the surface tension and contact angle) must at least balance the weight of the particle. The surface tension and contact angle can be modified by adding species which alter the interfacial properties, e.g., oils or surfactants. A needle can be made to float on water by coating it with oil so that the contact angle becomes greater than  $90^\circ$ . An example in particle flotation is given in Section 3.5. Density and contact angle are usually modified in a froth flotation process. Thus “collector” oils or surfactants can be added to ores which adsorb on desirable ore particles increasing the contact angle (and promoting attachment to gas bubbles), but which do not adsorb much on undesirable particles (which do not then attach to the gas bubbles). This combined surface modification and gas bubble attachment allows the desired particles to be made lighter and selectively floated. The ore particles and attached air bubbles rise to the surface of the liquid, from which they are recovered as a particle-rich foam, or froth. A foaming agent (lowers surface tension) can be added along with air addition to help stabilize the foam. Flotation processes thus involve careful modification of surface tension and contact angle.

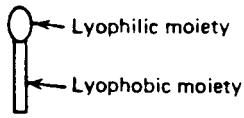
## 3.5

### Surfactants and Micelles

#### 3.5.1

##### Surface Activity

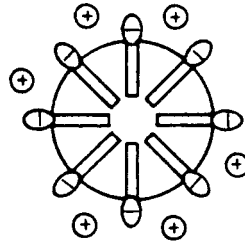
Some compounds, like short-chain fatty acids, are amphiphilic or amphipathic, i.e., they have one part that has an affinity for the nonpolar media (the nonpolar hydrocarbon chain) and one part that has an affinity for polar media such as water (the polar group). The energetically most favourable orientation for these molecules is at surfaces or interfaces so that each part of the molecule can reside in an environment for which it has the greatest affinity (see Figure 3.18). These molecules that form



Surfactant anion

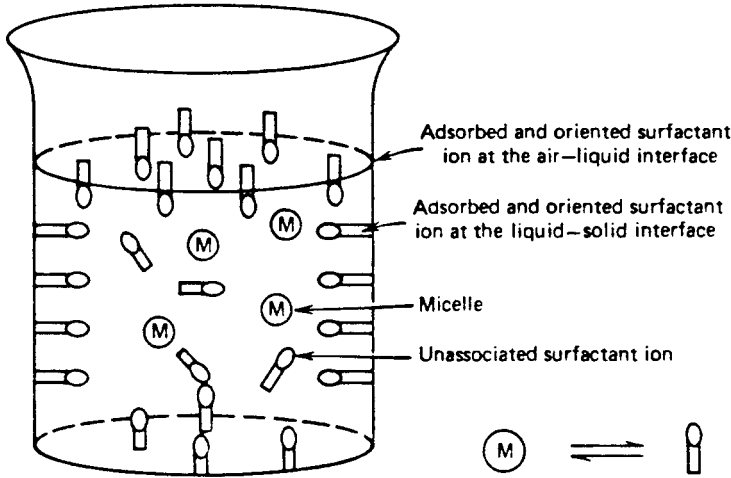


Counterion



Spherical micelle of an anionic surfactant with its counter ions

(a)



(b)

**Figure 3.18** Illustration of an anionic surfactant solution at equilibrium above its critical micelle concentration, showing the components (upper) and the locations of the components at equilibrium (lower). From Cahn and Lynn [206]. Copyright 1983, Wiley.

oriented monolayers at interfaces show surface activity and are termed surfactants<sup>1)</sup>. Soaps (fatty acid salts containing at least eight carbon atoms) are surfactants. Surfactants form a unique class of chemical compounds, having the ability to radically alter surface and interfacial properties and to self-associate and solubilize themselves in micelles. These properties provide the means to apply surfactants in wett-

1) Synonyms for surfactants include amphiphiles, surface-active agents, tensides, or, in the very old literature, paraffin-chain salts.

ability modification, detergency, and the displacement of liquid phases through porous media on one hand, and to stabilize dispersions, (including foams, froths and emulsions), or to destabilize dispersions (again including foams and emulsions) on the other hand.

Surfactant molar masses range from a few hundreds up to several thousands. As there will be a balance between adsorption and desorption (due to thermal motions) the interfacial condition requires some time to establish. Because of this, surface activity should be considered a dynamic phenomenon. This can be seen by measuring surface tension versus time for a freshly formed surface.

A consequence of surfactant adsorption at an interface is that it provides an expanding force acting against the normal interfacial tension. If  $\pi$  is this expanding pressure (surface pressure) then  $\gamma = \gamma_{\text{solvent}} - \pi$ . Thus surfactants tend to lower interfacial tension. If a low enough value of  $\gamma$  is reached, emulsification can take place because only a small increase in surface free energy is required, e.g., when  $\pi \approx \gamma_{\text{solvent}}$ . If solute–solvent forces are greater than solvent–solvent forces, on the other hand, then molecular migration away from the interface can occur, causing increased surface tension (e.g.,  $\text{NaCl}_{\text{aq}}$ ).

From thermodynamics, the lowering of surface free energy due to surfactant adsorption is given by the Gibbs adsorption equation for a binary, isothermal system containing excess electrolyte:

$$\Gamma_S = -(1/RT) (d\gamma/d\ln C_S) \quad (3.22)$$

where  $\Gamma_S$  is the surface excess of surfactant ( $\text{mol}/\text{cm}^2$ ),  $R$  is the gas constant,  $T$  is absolute temperature,  $C_S$  is the solution concentration of the surfactant ( $M$ ), and  $\gamma$  may be either surface or interfacial tension ( $\text{mN}/\text{m}$ ). This equation can be applied to dilute surfactant solutions where the surface curvature is not great and where the adsorbed film can be considered to be a monolayer. The packing density of surfactant in a monolayer at the interface can be calculated as follows. According to Eq. (3.22), the surface excess in a tightly-packed monolayer is related to the slope of the linear portion of a plot of surface tension versus the logarithm of solution concentration. From this, the area per adsorbed molecule ( $A_S$ ) can be calculated from:

$$A_S = 1 / (N_A \Gamma_S) \quad (3.23)$$

where  $N_A$  is Avogadro's number. Numerous examples are given by Rosen [32].

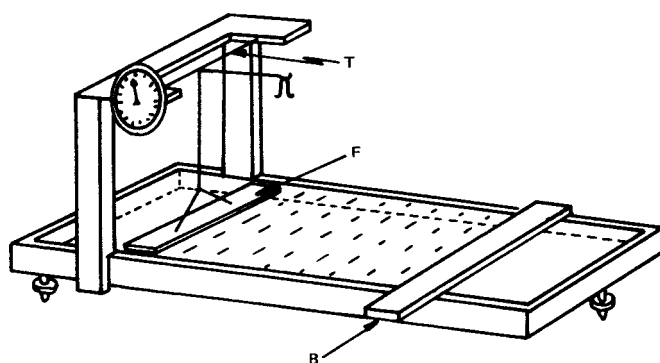
To give some sense of the extent to which surfactants can lower surface and interfacial tension, many hydrocarbon surfactants, at high concentrations (above the critical micelle concentration; see Section 3.5.3), can lower the surface tension of water at  $20^\circ\text{C}$  from  $72.8 \text{ mN}/\text{m}$  to about  $28 \text{ mN}/\text{m}$ . Polysiloxane surfactants can reduce it further, to about  $20 \text{ mN}/\text{m}$ , and perfluoroalkyl surfactants can reduce it still further, to about  $15 \text{ mN}/\text{m}$ . Similarly, hydrocarbon surfactants can reduce the interfacial tension of water–mineral oil from about  $40$  down to about  $3 \text{ mN}/\text{m}$ .

When surfactants concentrate in an adsorbed monolayer at a surface the interfacial film may provide a stabilizing influence in thin films and foams since they can both lower interfacial tension and increase the interfacial viscosity. The latter provides a mechanical resistance to film thinning and rupture.

Insoluble polar molecules (e.g., long chain fatty acids) exhibit an extreme kind of adsorption at liquid surfaces. That is, they can be made to concentrate in one molecular layer at the surface. These interfacial films often provide the stabilizing influence in emulsions since they can both lower interfacial tension and increase the interfacial viscosity. The latter provides a mechanical resistance to coalescence. Such systems also lend themselves to the study of size, shape, and orientation of molecules at an interface. Having an adsorbed layer lowers the surface tension (to  $\gamma_{\text{solution}}$ ) by the surface pressure  $\pi = \gamma_{\text{solvent}} - \gamma_{\text{solution}}$  as already noted.

### Film Balance

In the Langmuir film balance, a shallow trough is filled with a liquid, on top of which is placed material that can form a monolayer. The total surface area available can be adjusted by moveable barriers, and by means of a float. Any surface pressure thus created ( $\pi$ ) can be measured directly. See Figure 3.19.



**Figure 3.19** Langmuir film (or surface) balance for the study of monolayers. The float (F) is attached to a torsion wire (T), that is used to measure the force on the float caused by the expanding surface film contained between it and the barrier (B). The area available for the film can be adjusted by repositioning the barrier. From Leja [91]. Copyright 1982, Plenum Press.

Another approach would be to measure the lowered surface tension (Wilhelmy plate) and calculate  $\pi$ . For very low film pressures an ideal gas law analogy is:

$$\pi A = nRT = nN_A kT \quad (3.24)$$

Measurement of  $\pi$  and a knowledge of  $A$  allows calculation of the number of moles in the surface, from which the effective area per molecule in the monolayer can be obtained as  $A/(nN_A)$ .

**Example.** The results from surface balance experiments involving surface films of palmitic ( $C_{15}H_{31}COOH$ ), stearic ( $C_{17}H_{35}COOH$ ), and cerotic ( $C_{25}H_{51}COOH$ ) acids show that each exhibits an area per molecule in the monolayer of  $21 \text{ \AA}^2$ . This is only possible for molecules with such different hydrocarbon tail lengths if they each orient vertically in their respective monolayers.



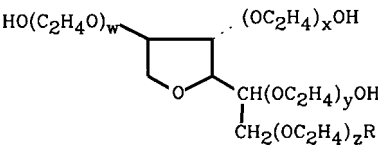
Monolayers can be used to retard evaporation (water reservoirs), a related effect is the use of an oil film to dampen waves (surface viscosity), interfacial films are often the stabilizing agent in emulsions (lower  $\gamma$  and increase  $\eta^S$ ).

## 3.5.2

**Classification and Analysis of Surfactants**

Surfactants are classified according to the nature of the polar (hydrophilic) part of the molecule, as illustrated in Table 3.3. Typically the molar masses range from a few hundreds to several thousands of g/mol. In depth discussions of surfactant structure and chemistry can be found in Refs. [32,160–162]. A recent review is given by Schramm *et al.* [163]. A good discussion of the chemistry of commercially available surfactants is given by Myers [31]. Several reviews are available on the toxicity and persistence of surfactants [164–167].

**Table 3.3** Illustration of surfactant classifications.

Class	Examples	Structures
Anionic	Na stearate	$\text{CH}_3(\text{CH}_2)_{16}\text{COO}^-\text{Na}^+$
	Na dodecyl sulfate	$\text{CH}_3(\text{CH}_2)_{11}\text{SO}_4^-\text{Na}^+$
	Na dodecyl benzene sulfonate	$\text{CH}_3(\text{CH}_2)_{11}\text{C}_6\text{H}_4\text{SO}_3^-\text{Na}^+$
Cationic	Laurylamine hydrochloride	$\text{CH}_3(\text{CH}_2)_{11}\text{NH}_3^+\text{Cl}^-$
	Trimethyl dodecylammonium chloride	$\text{C}_{12}\text{H}_{25}\text{N}^+(\text{CH}_3)_3\text{Cl}^-$
	Cetyl trimethylammonium bromide	$\text{CH}_3(\text{CH}_2)_{15}\text{N}^+(\text{CH}_3)_3\text{Br}^-$
Non-ionic	Polyoxyethylene alcohol	$\text{C}_n\text{H}_{2n+1}(\text{OCH}_2\text{CH}_2)_m\text{OH}$
	Alkylphenol ethoxylate	$\text{C}_9\text{H}_{19}-\text{C}_6\text{H}_4-(\text{OCH}_2\text{CH}_2)_n\text{OH}$
	Polysorbate 80 $w+x+y+z=20$ , $\text{R}=(\text{C}_{17}\text{H}_{33})\text{COO}$	
Propylene oxide-modified polymethylsiloxane	$(\text{CH}_3)_3\text{SiO}((\text{CH}_3)_2\text{SiO})_x(\text{CH}_3\text{SiO})_y\text{Si}(\text{CH}_3)_3$	
EO = ethyleneoxy PO = propyleneoxy	$\text{CH}_2\text{CH}_2\text{CH}_2\text{O}(\text{EO})_m(\text{PO})_n\text{H}$	
Zwitterionic	Dodecyl betaine	$\text{C}_{12}\text{H}_{25}\text{N}^+(\text{CH}_3)_2\text{CH}_2\text{COO}^-$
	Lauramidopropyl betaine	$\text{C}_{11}\text{H}_{23}\text{CONH}(\text{CH}_2)_3\text{N}^+(\text{CH}_3)_2\text{CH}_2\text{COO}^-$
	Cocoamido-2-hydroxy-propyl sulfobetaine	$\text{C}_n\text{H}_{2n+1}\text{CONH}(\text{CH}_2)_3\text{N}^+(\text{CH}_3)_2\text{CH}_2\text{CH}(\text{OH})\text{CH}_2\text{SO}_3^-$

Many methods have been developed for the quantitative determination of each class of surfactants. The analysis of commercial surfactants is much more complicated since they may be comprised of a range of compounds within a given structural class, may contain surface-active impurities, may be formulated to contain several different surfactant classes, and may be dissolved in mixed organic solvents or complex aqueous salt solutions. Each of these components has the potential to interfere with a given analytical method so surfactant assays are sometimes preceded by surfactant separation techniques. Both the separation and assay techniques can be highly specific to a given surfactant/solution system. Table 3.4 shows some typical kinds of analysis methods that are applied to the different surfactant classes.

**Table 3.4** Typical methods of surfactant analysis.

Surfactant Class	Method
<i>Anionic</i>	
Alkyl sulfates and sulfonates	Two-phase or surfactant-electrode monitored titration
Petroleum and lignin sulfonates	Column or gel permeation chromatography
Phosphate esters	Potentiometric titration
Sulfosuccinate esters	Gravimetric or titration methods
Carboxylates	Potentiometric titration or two-phase titration
<i>Non-ionic</i>	
Alcohols	NMR or IR spectroscopy
Ethoxylated acids	Gas chromatography
Alkanolamides	Gas chromatography
Ethoxylated amines	HPLC
Amine oxides	Potentiometric titration
<i>Cationic</i>	
Quaternary ammonium salts	Two-phase or surfactant-electrode monitored titration, or GC or HPLC
<i>Amphoteric</i>	
Carboxybetaines	Low pH two-phase titration, gravimetric analysis, or potentiometric titration
Sulfobetaines	HPLC

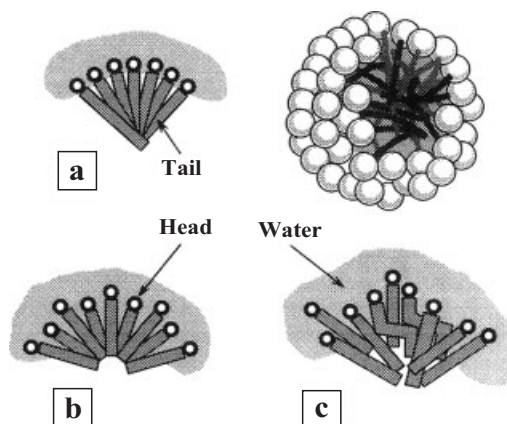
There are a number of books [168–173] and reviews [68,174,175] that provide good starting points. Refs. [168,176–178] discuss methods for the determination of anionic surfactants, which are probably the most commonly encountered in industry. Most of these latter methods are applicable only to the determination of sulfate- and sulfonate-functional surfactants. Probably the most common analysis method for anionic surfactants is Epton's two-phase titration method [179,180] or one of its variations [171,172,181–183]. Additional references are provided elsewhere [163]. Aqueous surfactant micellar systems have also been utilized successfully in virtually every area of analytical chemistry (for example, [184–186]).

## 3.5.3

**Micelles**

In aqueous solution dilute concentrations of surfactant act much as normal electrolytes, but at higher concentrations very different behaviour results [25,32]. This behaviour was explained by McBain in terms of the formation of organized aggregates of large numbers of molecules (about 20–100 molecules/micelle) called micelles. The most commonly held view of a surfactant micelle is not much different from that published by Hartley in 1936 [187,188] in which the lipophilic parts of the surfactants associate in the interior of the aggregate, leaving hydrophilic parts to face the aqueous medium (Figure 3.20). The micellar interior, being composed essentially of hydrocarbon chains, has properties closely related to the liquid hydrocarbon. The formation of micelles in aqueous solution is generally viewed as a compromise between the tendency for alkyl chains to avoid energetically unfavourable contacts with water, and the desire for the polar parts to maintain contact with the aqueous environment. A solution of micelles is a good example of a thermodynamically stable lyophilic colloidal dispersion. A thermodynamic description of the process of micelle formation in aqueous solutions involves the hydrophobic effect, which leads to mutual association of the hydrophobic chains [163].

The concentration at which micelle formation becomes significant is called the critical micelle concentration (cmc). The cmc is a property of the surfactant and several other factors, including the temperature, pressure, and the presence and nature of additives, since micellization is opposed by thermal and electrostatic forces. A low cmc is produced by increasing the molecular mass of the lipophilic part of the molecule, lowering the temperature (usually), and adding electrolyte (usually). For exam-



**Figure 3.20** Illustration of the structure of a micelle in aqueous solution, showing three arrangements: tails overlapping at the centre (a), water penetrating the core (b), and chain protrusion and bending to correct the deficiencies of the first two arrangements (c). From Hiemenz and Rajagopalan [13]. Copyright 1997, Dekker.

ple, the cmc can be as low as  $10^{-6}$  M for high chain length non-ionic surfactants. Surfactant molecular masses range from a few hundreds up to several thousands. Although commonly referred to as a critical concentration, it is clear that the transition between monomers and micelles actually occurs over a narrow range of concentrations. The breadth of this range is determined primarily, but is by no means limited to, the length and nature of the surfactant tails. Compilations of cmc values are given in references [32,189].

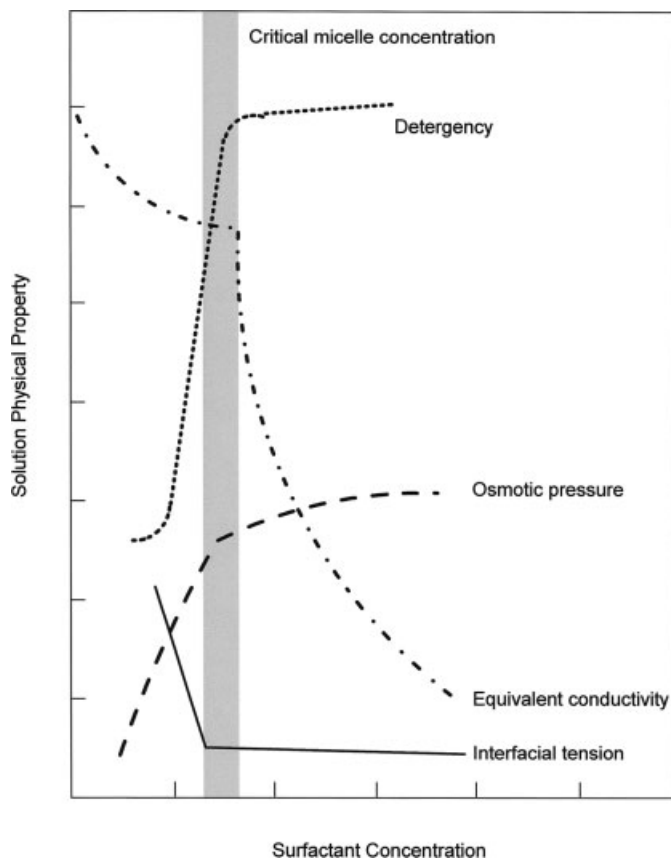
Some typical molar cmc values for low electrolyte concentrations at room temperature are:

	cmc (M)
Non-ionics	$10^{-5} - 10^{-4}$
Anionics	$10^{-3} - 10^{-2}$
Amphoterics	$10^{-3} - 10^{-1}$

The physico-chemical properties of surfactants vary sharply above and below the cmc value, as shown in Figure 3.21 [190]. Below the cmc physico-chemical properties of ionic surfactants like sodium dodecylsulfate, SDS, (e.g., conductivities, electromotive force measurements) resemble those of a strong electrolyte. Above the cmc these properties change dramatically, indicating that a highly cooperative association process is taking place. The characteristic shape of the curve in Figure 3.21 is not restricted to physical properties of micelles but can apply to chemical reactions involving micelles. For example, Huang *et al.* [191] have found that plotting the reaction rate for micellar catalysis against surfactant concentration can also produce the same curve shape.

The cmc values are important in virtually all of the process industry surfactant applications, from mineral processing to formulation of personal care products and foods, to drug delivery systems, and to new surfactant remediation technologies. In these processes, surfactant must usually be present at a concentration higher than the cmc because the greatest effect of the surfactant, whether in interfacial tension lowering, emulsification, suspension stabilization, as a delivery vehicle, or in promoting foam stability, is achieved when a significant concentration of micelles is present. The cmc is also of interest because at concentrations above this value the adsorption of surfactant at interfaces usually increases very little. That is, the cmc frequently represents the solution concentration of surfactant from which nearly maximum adsorption occurs. Since the cmc controls the surfactant monomer concentration, the cmc value is important for any context in which monomer effects are a primary consideration. For example, low monomer concentrations are desirable in shampoo formulations in order to reduce eye and skin irritation, whereas high monomer concentrations are desirable in biocide formulations in order to increase the biocidal activity.

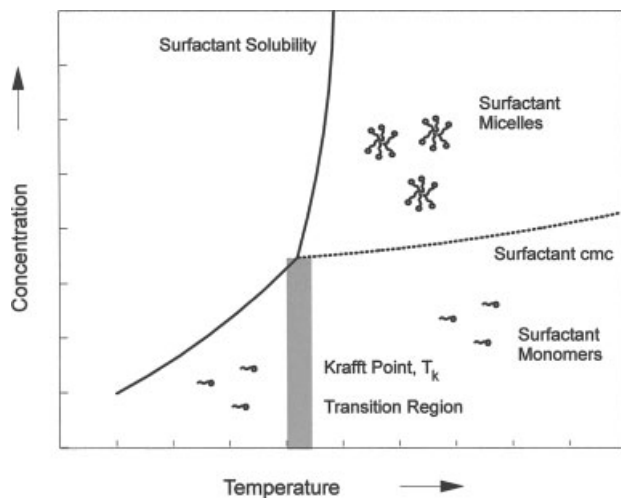
The solubilities of micelle-forming surfactants show a strong increase above a certain temperature, termed the Krafft point ( $T_k$ ). This is explained by the fact that the single surfactant molecules have limited solubility whereas the micelles are very soluble. Referring to Figure 3.22, below the Krafft point the solubility of the surfactant



**Figure 3.21** Changes in physical properties of an aqueous surfactant solution at concentrations near the critical micelle concentration, shown here as a narrow range of concentrations.

is too low for micellization and solubility alone determines the surfactant monomer concentration [192]. As temperature increases, the solubility increases until at  $T_K$  the cmc is reached. At this temperature a relatively large amount of surfactant can be dispersed in micelles and solubility increases greatly. Above the Krafft point, maximum reduction in surface or interfacial tension occurs at the cmc because now the cmc determines the surfactant monomer concentration. Krafft points for a number of surfactants are listed in Ref. [31].

Non-ionic surfactants do not exhibit Krafft points. Rather the solubility of non-ionic surfactants decreases with increasing temperature and the surfactants begin to lose their surface active properties above a transition temperature referred to as the cloud point. This occurs because above the cloud point a separate surfactant-rich phase of swollen micelles separates; the transition is visible as a marked increase in dispersion turbidity. As a result, the foaming ability of, for example, polyoxyethylenated non-ionics, decreases sharply above their cloud points. The addition of electro-



**Figure 3.22** Illustration of the solubility-micellization behaviour of surfactants in solution, showing the Krafft point.

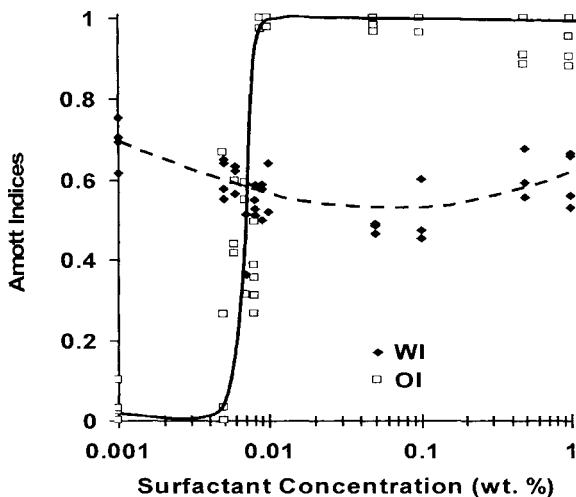
lyte usually lowers the cloud point, while the addition of ionic surfactant usually increases the cloud points of their non-ionic counterparts, this increase being dependent on the composition of the mixed micelle.

As surfactant concentrations increase above the cmc, micelles in solution will begin to pack together in ways that depend on the geometry of the individual micelles. Packed arrangements of micelles are called liquid crystals. Of particular importance in the utilization of surfactants are the hexagonal and lamellar liquid crystals that are formed by the packing together of cylindrical micelles and lamellar micelles, respectively. With an increase in the concentration of the surfactant, a tendency can exist for surfactant micelles often to change from spherical to cylindrical, and then to lamellar. Consequently hexagonal liquid crystals are usually encountered at lower surfactant concentrations than lamellar phases. Spherical micelles can pack together to form cubic liquid crystals, but these are usually encountered only at very high concentrations of surfactant, where they produce very high viscosity liquid crystal gels [193]. The ability of biological amphiphilic molecules to aggregate into spherical and non-spherical clusters, i.e., vesicles, may have been important for the development of early living cells [194].

Surfactant, by adsorbing at a solid surface, can be used to selectively alter wettability. When the adsorbed surfactant orientation is such that its hydrophobic tail groups point away from the surface or along the surface, there will result a decrease in water-wetting and an increase in oil-wetting. Likewise, if the orientation is with the polar head group, away from the surface there will result an increase in water-wetting. In addition to the dual nature of surfactant molecules, specific structural characteristics can increase or decrease the packing of surfactant molecules and consequently influence surface wettability. A number of studies have shown wettability shifts from oil-wetting towards water-wetting due to surfactant adsorption [195,196].

This topic is discussed in detail by Spinler and Baldwin [158]. Figure 3.23 shows an example of surfactant-induced wettability alteration in a porous sandstone. In this case a strongly water-wet porous media was shifted to weakly oil-wet in some pathways but not others, resulting in continuous flow pathways for both water and oil, hence high values for both WI and OI. Another example of surfactant-induced wettability alteration can be found in the treatment of swelling clays, such as montmorillonite, with a cationic surfactant, such as dimethyl di(hydrogenated tallow) ammonium, in order to produce organophilic clay for use in non-aqueous drilling muds [197,198].

For example, in mineral flotation, surfactant can be added to adsorb on metal ore particles, increasing the contact angle, so they attach to gas bubbles, but the surfactant does not adsorb much on silicates, so these do not attach to gas bubbles. The surfactant may also stabilize a foam containing the desired particles facilitating their recovery as a particle-rich froth that can be skimmed. Flotation processes thus involve careful modification of surface tension and wettability.

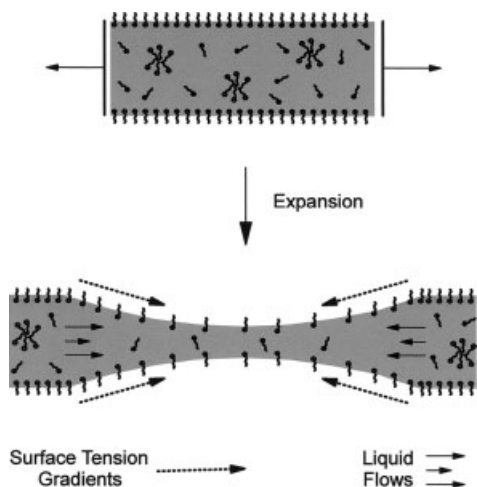


**Figure 3.23** The alteration of both oil- and water wettability in porous sandstone due to surfactant adsorption. From Spinler and Baldwin [158]. Copyright 2000, Cambridge University Press.

#### 3.5.4

##### Surface Elasticity

In concentrated emulsions and foams the thin liquid films that separate the droplets or bubbles from each other are very important in determining the overall stability of the dispersion. In order to be able to withstand deformations without rupturing, a thin liquid film must be somewhat elastic. The surface chemical explanation for thin film elasticity comes from Marangoni and Gibbs (see Ref. [199]). When a surfactant-stabilized film undergoes sudden expansion, then immediately the expanded



**Figure 3.24** Illustration of the origin of surface elasticity as a liquid film is expanded.

portion of the film must have a lower degree of surfactant adsorption than unexpanded portions because the surface area has increased (see Figure 3.24). This causes an increased local surface tension which provides increased resistance to further expansions. If unchecked, further thinning would eventually lead to film rupture. However, the local rise in surface tension produces an immediate contraction of the surface. Since the surface is coupled by viscous forces to the underlying liquid layers, the contraction of the surface induces liquid flow from the low-tension region to the high-tension region. The transport of bulk liquid due to surface tension gradients is termed the Marangoni effect; it re-thickens the thin films and provides a resisting force to film thinning.

This Marangoni effect only exists until the surfactant adsorption equilibrium is re-established in the film, a process that may take place within seconds or over a period of hours. In thick films this can take place quite quickly. However, in thin films there may not be enough surfactant in the extended surface region to re-establish the equilibrium quickly, requiring diffusion from other parts of the film. The restoring processes then, are the movement of surfactant along the interface, from a region of low surface tension to one of high surface tension, and the movement of surfactant from the thin film into the now depleted surface region. The Gibbs–Marangoni effect provides a force to counteract film rupture, but is probably significant mainly for either rapid deformations or for stabilizing very thin films. The effect can, in principle, be studied either by direct elasticity measurements or by dynamic surface tension measurements coupled with some information about diffusion rates.

Many surfactant solutions show dynamic surface tension behaviour. That is, some time is required to establish the equilibrium surface tension. If the surface area of the solution is suddenly increased or decreased (locally), the adsorbed surfac-



tant layer at the interface would then require some time to restore its equilibrium surface concentration by diffusion of surfactant from, or to the bulk liquid (see Ref. [200] for a review). In the meantime, the original adsorbed surfactant layer itself is either expanded or contracted; since surface tension gradients are now in effect there arise Gibbs–Marangoni forces acting in opposition to the initial disturbance.

At equilibrium, the surface elasticity, or surface dilational elasticity,  $E_G$ , is defined [15,25] by:

$$E_G = d\gamma / d \ln A \quad (3.27)$$

where  $\gamma$  is the surface tension and  $A$  is the geometric area of the surface. This is related to the compressibility of the surface film,  $K$ , by  $K = 1/E_G$ . For a foam lamella there are two such surfaces and the elasticity becomes

$$E_G = 2d\gamma / d \ln A \quad (3.28)$$

The subscript  $G$  specifies elasticity determined from isothermal equilibrium measurements, such as for the spreading pressure-area method, which is a thermodynamic property and is termed the Gibbs surface elasticity,  $E_G$ .  $E_G$  occurs in very thin films where the number of molecules is so low that the surfactant cannot restore the equilibrium surface concentration after deformation.

The surface elasticity determined from non-equilibrium dynamic measurements depends upon the stresses applied to a particular system, is generally larger in magnitude, and is termed the Marangoni surface elasticity,  $E_M$  [25,201]. See also Section 6.6. Marangoni elasticity can be determined experimentally from dynamic surface tension measurements that involve known surface area changes (see, for example, Refs. [202,203]). The time-dependent Marangoni elasticity is of particular interest for foams. Surface elasticity measures the resistance against creation of surface tension gradients and of the rate at which such gradients disappear once the system is again left to itself [204].

There is no simple, direct relationship between elasticity and emulsion or foam stability because additional factors, such as film thickness and adsorption behaviour, are also important [204]. Nevertheless, several researchers have found useful correlations between  $E_M$  and emulsion or foam stability [131,201,203]. The existence of surface elasticity explains why some substances that lower surface tension do not stabilize foams [25]. That is, they do not have the required rate of approach to equilibrium after a surface expansion or contraction as they do not have the necessary surface elasticity. Although greater surface elasticity tends to produce more stable bubbles, if the restoring force contributed by surface elasticity is not of sufficient magnitude, then persistent foams may not be formed due to the overwhelming effects of the gravitational and capillary forces. More stable foams may require additional stabilizing mechanisms.

Dynamic surface tensions, and related phenomena such as surface elasticity are also important in areas such as photography, where the dynamic surface tension is monitored to prevent film deformation and irregularities, in crop protection prod-

ucts where wettability rate is vital for pesticide spreading on leaves, in biological processes, and in paper and textile production [205].

### 3.6

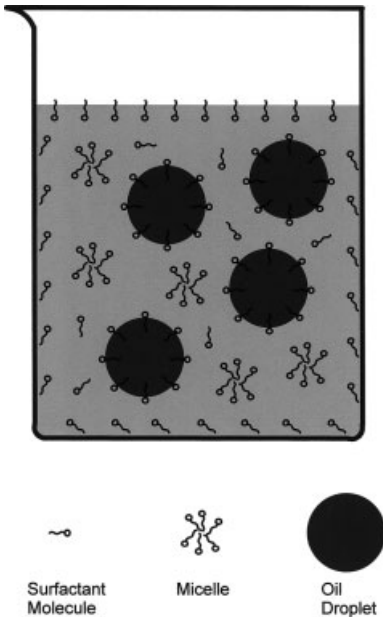
#### Applications of Surface Activity

There are numerous surfactant applications. Cahn and Lynn [206] list about 50 types. Most of these applications can be classified in terms of surfactant action to promote emulsification, foaming, flotation, suspension, detergency or wetting.

#### 3.6.1

##### Surfactants and Emulsification

In most cases “stable” emulsions are caused by the presence of an emulsifying agent residing at the liquid–liquid interface (see Figure 3.25). Surfactants can play an important role in the formation and stability of emulsions, by any or all of the following: lowering interfacial tension; increasing surface elasticity; increasing electric double layer repulsion (ionic surfactants); lowering the effective Hamaker constant; and increasing surface viscosity. For maximum efficiency and effectiveness good emulsifying agents have limited solubility in both the oil and water phases of the system. Emulsions also tend to be more stable when there is tighter packing of hydrophobic groups at the oil/water interface [193]. The nature of the surfactant can also determine the arrangement of the phases (i.e., which phase will form the dis-



**Figure 3.25** Surfactant associations in an O/W emulsion. The size of the surfactant molecules compared to the oil droplets has been greatly exaggerated for the purposes of illustration.

persed versus continuous phase). For this there are several empirical predictive approaches based on anticipated surfactant positioning at the interface [25,37,95,207], including Bancroft's rule (see Section 7.1.1), the oriented wedge theory (which can also be applied to fine solids, see Section 7.1.1), the hydrophile–lipophile balance (HLB), and the volume balance value [208]. Although there are exceptions to each of these rules, they remain useful for making initial predictions.

Of these the HLB has been the most used. This dimensionless scale ranges from 0–20 for non-ionic surfactants; a low HLB (<9) refers to a lipophilic surfactant (oil soluble) and a high HLB (>11) to a hydrophilic (water soluble) surfactant. Most ionic surfactants have HLB values greater than 20, for example, sodium dodecyl sulfate has an HLB of 40. Some examples of surfactant HLBs are given in Table 3.5. In general, water-in-oil (W/O) emulsifiers exhibit HLB values in the range 3–8 while oil-in-water (O/W) emulsifiers have HLB values of about 8–18. There exist empirical tables of HLB values required to make emulsions out of various materials [209,210]. If the value is not known, then lab emulsification tests are required, using a series of emulsifying agents of known HLB values [210]. There are various compilations and equations for determining emulsifier HLB values [96,207,209–211]. The HLB concept, and examples of its use, are discussed further in Section 7.1.1.

**Table 3.5** Approximate Surfactant HLB Values\*

Surfactant	HLB
Oleic acid	1
Sorbitan tristearate (SPAN 65)	2
Sorbitan monooleate (SPAN 80)	4
Diethylene glycol monolaurate	6
Sorbitan monolaurate (SPAN 20)	9
Glycerol monostearate	11
Polyoxyethylene (10) cetyl ether (BRIJ 56)	13
Polyoxyethylene sorbitan monooleate (TWEEN 80)	15
Sodium octadecanoate	18
Sodium dodecanoate	21
Sodium octanoate	23
Diethyl sodium sulfosuccinate	32
Sodium heptadecyl sulfate	38
Sodium dodecyl sulfate	40
Sodium octyl sulfate	42

\* Compiled from data in references [14,31,96,207].  
SPAN, BRIJ, and TWEEN are trademarks of ICI Americas Inc.

The HLB is an indicator of the emulsifying characteristics of an emulsifier, but not its efficiency. Thus, while all emulsifiers having a high HLB will tend to promote O/W emulsions, there will be a considerable variation in the efficiency with which those emulsifiers act for any given system. For example, mixtures of surfac-

tants usually work better than pure compounds of the same HLB. (See also Section 7.1.1).

Just as solubilities of emulsifying agents vary with temperature, so does the HLB, especially for the non-ionic surfactants. A surfactant may thus stabilize O/W emulsions at low temperature, but W/O emulsions at some higher temperature. The transition temperature, at which the surfactant changes from stabilizing O/W to W/O emulsions, is known as the phase inversion temperature, PIT. At the PIT, the hydrophilic and oleophilic natures of the surfactant are essentially the same (another term for this is the HLB temperature). As a practical matter, emulsifying agents are chosen so that their PIT is far from the expected storage and use temperatures of the desired emulsions. In one method [212] an emulsifier with a PIT of about 50 °C higher than the storage/use temperature is selected. The emulsion is then prepared at the PIT where very small droplet sizes are most easily created. Next, the emulsion is rapidly cooled to the desired use temperature, where now the coalescence rate will be slow, and a stable emulsion results. Further details can be found in Ref. [213].

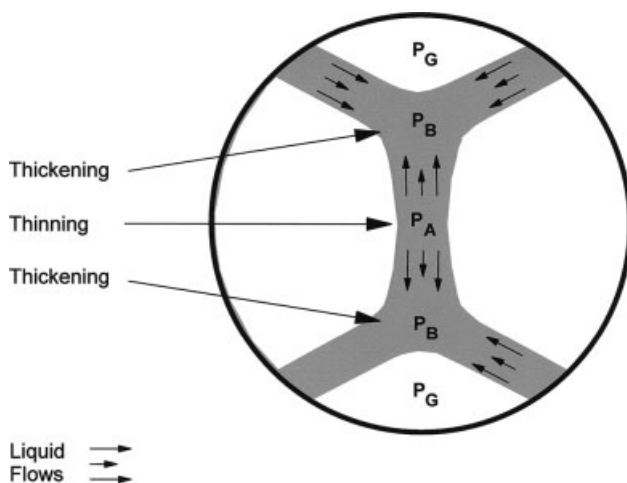
Very finely divided emulsions can be prepared by increasing the temperature of the system, forcing an O/W emulsion to invert to a fine W/O emulsion, then cooling the system, causing re-inversion with the formation of very small dispersed oil drops [214]. This method is termed the PIT method.

In addition to influencing stability, the nature of the emulsifier can also have an influence on droplet size distribution, the mean droplet size, and also on emulsion viscosity [215] (see also Section 6.5.5).

### 3.6.2

#### Surfactants and Foaming

Foams are partly characterized by their relative stability to film drainage and rupture. In most cases “stable” foams are caused by the presence of a foaming agent residing at the gas–liquid surface. Surfactant adsorption at the L/G interface lowers the interfacial energy and makes it easier to create and maintain the large interfacial area associated with having many gas bubbles in a liquid. It also increases the interfacial viscosity,  $\eta^S$ , which promotes stability as well. Immediately after foam generation, there will always be a tendency for liquid to drain due to the force of gravity. This liquid will drain by flowing downwards through the existing liquid films, the interior of the lamellae. Eventually the gas bubbles will no longer be even approximately spherical (kugelschaum) and relatively planar lamellae will separate polyhedral shaped bubbles (polyederschaum). At this point the capillary forces will become competitive with the forces of gravity. From Figure 3.26 it can be seen that, at the plateau borders, the gas/liquid interface is quite curved, generating a low pressure region in the plateau area (see Young–Laplace Equation). Since the interface is flat along the thin film region, a higher pressure resides here. This pressure difference forces liquid to flow towards the plateau borders causing thinning of the films and motion in the foam. Unchecked, this thinning process will lead to film rupture and cause foam collapse. But a restoring force can be present through the Marangoni effect.



**Figure 3.26** Pressure differences across the curved surfaces in a foam lamella leading to  $P_A > P_B$  and liquid flow towards Plateau borders at the expense of film thinning.

Foaming ability reaches its maximum at or above the cmc of the surfactant. Ionic surfactants are better foamers than non-ionics, presumably because their ionic head groups increase the stability of the foam through electrostatic repulsion between the two sides of the foam lamella [193]. Generally, foaming ability increases with increasing alkyl chain length in the hydrophobic group and decreases with branching in the hydrophobic group. Foaming also tends to be decreased by any structural factor that increases the cross-sectional area of the surfactant at the surface, e.g., branching in the hydrophobic group, an increase in the number of oxyethylene units in the hydrophilic group of non-ionics, or “capping” of the terminal hydroxyl of the polyoxyethylene group with a less water-soluble group [193].

### 3.6.3

#### Surfactants and Flotation

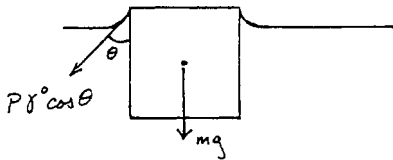
The flotation of solid particles on a liquid medium depends on the contact angle, which can be changed by the addition of surfactants. A familiar elementary chemistry demonstration consists of making a needle float on the surface of water by coating it in wax. Subsequent addition of a household detergent sinks the needle. The principles are the same as in the treatment of crude mineral ores by flotation, for which a small amount of collector oil is added during the grinding and slurring process. The collector oil, which is an anionic, cationic, or non-ionic surfactant, acts to alter the wettability of the ore particles. Organic xanthates and thiophosphates are often used for sulphide ores and long-chain fatty acids for oxide and carbonate ores. In practise, a foaming agent is usually also added so that when air is blown through the suspension the ore particles attach to the air bubbles. The ore particles then float

to the surface where they are recovered by skimming [91]. Flotation of this kind is also used as a purification procedure for sludges and effluents.

**Example:** In flotation, for a solid particle to float on a liquid surface, the upward pull of the meniscus around it (reflected in  $\theta$ ) must at least balance the weight of the particle. Any natural tendency of the particles to float or not float, depending on  $\theta$ , can be modified by adding oils or surfactants to alter the interfacial properties. A mineral particle that does not float (Case 1) can be floated by adding surfactant (Case 2) as follows.

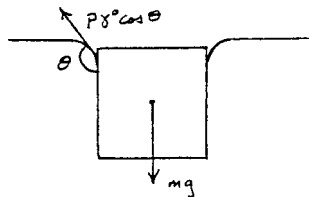
Consider a cube-shaped mineral particle (sides of length  $L=100\ \mu\text{m}$ ) placed on the surface of a container of water of surface tension  $\gamma=72\ \text{mN/m}$ . Say it exhibits a contact angle of  $\theta=45^\circ$  and a density difference  $\Delta\rho=(2.4-1.0)\ \text{g/cm}^3$ . Ignoring the effects of immersion depth and taking upward force to be positive, the force due to surface tension is given by  $-4L\gamma\cos\theta$  while the force due to gravity is given by  $-L^3\Delta\rho g$ . The net force is then approximately  $-2.03 \times 10^{-2}\ \text{mN}$ , and the particle sinks (a). If instead, a surfactant is added to the water so that the solution surface tension becomes  $\gamma=40\ \text{mN/m}$  and the contact angle becomes  $\theta=140^\circ$ , then in this case the net force on the particle becomes  $+1.22 \times 10^{-2} - 1.37 \times 10^{-5}\ \text{mN} = +1.22 \times 10^{-2}\ \text{mN}$ , and the particle now floats (b).

(a) No surfactant.



$$F_{\text{up}} \approx -2.03 \times 10^{-2}\ \text{mN}, \text{ sinks}$$

(b) Added surfactant



$$F_{\text{up}} \approx +1.22 \times 10^{-2}\ \text{mN}, \text{ floats}$$

### 3.6.4

#### Surfactants and Suspensions

The stability of suspensions can also be increased by the adsorption of surfactants on the particles. Some guidelines include [193]:

- The dispersing ability of ionic surfactants for solids in aqueous media generally increases with an increase in the number of ionic groups in the surfactant molecule.
- For the dispersion of polar or ionic solids in aqueous media the hydrophobic group of the surfactant should contain polar groups, such as ether linkages, or polarizable groups, such as aromatic rings, capable of adsorbing onto the solid.
- Dispersing agents for polar or ionic solids in hydrocarbon media generally have polarizable lyophobic groups and long alkyl chains that can extend into the solvent. They can be monomeric or polymeric.

## 3.6.5

**Surfactants and Wetting**

The wetting of a liquid drop placed on a solid surface has already been described (Section 3.4) by the critical surface tension of the surface and by Young's equation. Temperature is a factor in wetting by aqueous solutions since it influences surfactant solubility. For example, the fastest wetting for polyoxyethylenated non-ionic surfactants is produced by those whose cloud points are just above the use temperature [193].

To reduce the wetting of water on a hydrophilic surface, to de-wet the surface, and/or to make it water repellent, the adsorption of a "greasy" material can be induced in order to increase the contact angle until it is substantially in the de-wetting range ( $\theta > 90^\circ$ ). Long-chain cationic surfactants are often used in the textile industry to make fabrics water-repellent. The cationic headgroups adsorb on the anionic textile surface exposing the long hydrocarbon chain to the water, producing a hydrophobic surface ( $\theta \approx 105^\circ$ ). In this case, a condition of negative capillary action is achieved and the pressure required to force water through the fabric is increased substantially, whereas the passage of air through the textile is not hindered.

To increase the wetting of a water drop on a hydrophobic surface, a little adsorption of a surfactant can be introduced (both surface tension and contact angle decrease). The fastest wetting is often produced by barely water-soluble surfactants, having either relatively small molar mass or having a branched hydrophobic group and a centrally located hydrophilic group [193]. Anionic surfactants are often applied where water-wetting is desired of a naturally waxy or wax-like surface (dips for animal hide, insecticides, herbicides, etc.). For example, most fabric surfaces have critical surface tensions in the range 20–46 mN/m, so reducing the surface tension of an aqueous solution to values below 40 mN/m by the addition of a suitable surfactant, permits the wetting of most textile fabrics. This can help ensure the even distribution of a textile dye. The ability of some siloxane surfactants to lower aqueous surface tensions to values (ca. 20 mN/m) lower than can be achieved using hydrocarbon surfactants, together with their ability to cause rapid spreading of aqueous solutions on hydrophobic surfaces (like polyethylene) makes them useful in paints and coatings [216], personal care products [217], textiles [218], the oil industry [219], and as adjuvants for pesticides [220] and herbicides [221,222]. Adjuvants, i.e., chemicals that increase the effects of biologically active compounds in agrochemical preparations, are often surfactants. Their ability to perform this function is at least partly due to their ability to enhance wetting and spreading, which reduces the amount of active ingredient needed to ensure satisfactory surface coverage of the agent [193]. An example is the use of non-ionic surfactants in herbicides sprayed on crops.

## 3.6.6

**Surfactants and Detergency**

Detergency involves the action of surfactants to alter interfacial properties and to reduce the energy needed to cause the removal of dirt from solid surfaces. In addi-

tion to the familiar household and personal care applications, most industrial process industries use surfactant solutions to clean metal surfaces. Usually wetting agents that rapidly diffuse and adsorb at appropriate interfaces are most effective as detergents. Soap, a surface active fatty acid salt containing at least eight carbon atoms, has long been used as a detergent. Soaps are excellent detergents, but suffer from their sensitivity to acid pHs and the presence of hardness in the water ( $\text{Ca}^{2+}$  and  $\text{Mg}^{2+}$  ions), causing soap scum. Although the use of detergent builders will compensate for this deficiency, soaps have largely been replaced by synthetic detergents, principally alkyl sulfates, alkyl-aryl sulfonates, and non-ionic polyethylene oxide derivatives.

Not all surfactants make acceptable detergents. For a surfactant to be considered a good detergent, it must be a good wetting agent, it must possess the ability to displace soil materials into the washing fluid, be a good solubilizing agent, and also be a reasonable anti-redeposition agent. The solid surface to be cleaned may be a hard surface (plates, high-density plastics) or a textile material (wool, cotton, synthetic fibres), or a part of the body (skin, hair, teeth). The dirt or soil may have variable chemical composition and particle sizes. In view of the possible surface/soil systems, theories of detergent action are limited in scope. For example, in detergent formulating, a difference is observed between wetting of “hard” surfaces (e.g., glass and metal) and “soft” surfaces (e.g., textiles). In the case of hard surfaces, the equilibrium tends to be established rapidly, whereas, for soft surfaces, kinetic effects can cause complications. For specialized detergent applications, the situation is even more complex, since performance tends to be judged by criteria which are not wholly related to dirt removal.

Surfactants that effectively adsorb at the solid–water and dirt–water interfaces make the best detergents. Consider a dirt (oil, mineral, carbon, etc.) particle adhering to a solid surface immersed in a liquid. The work of adhesion ( $\Delta G$ ) between the dirt and solid is,

$$W_{S/D} = \gamma_{D/W} + \gamma_{S/W} - \gamma_{S/D} \quad (3.29)$$

The detergent’s role is to lower  $\gamma_{D/W}$  and  $\gamma_{S/W}$ . This reduces  $W_{S/D}$  (so  $\Delta G$  is  $< 0$ ) and lowers the amount of mechanical energy required to dislodge the dirt (Figure 3.27). If the dirt is solid then it is a simple matter of wettability alteration. If the dirt is liquid rather than solid, similar reasoning applies, but a simpler description can be given in terms of the contact angles. If the contact angle (measured through the water) is  $0^\circ$  an oil drop is non-wetting and easily removed with mechanical agitation. If it is  $> 90^\circ$  then detachment of the drops will be like detaching drops from a capillary: with mechanical agitation they will form a neck and separate leaving behind a residue. Complete removal is slowly approached with increased agitation since smaller drops are progressively harder to detach. For complete removal a detergent is needed that is capable of reducing the contact angle making the oil drops “roll-up” so that detachment will be easier. Reference to Young’s equation shows that this must be done carefully as added surfactant changes the surface and interfacial tensions as well.



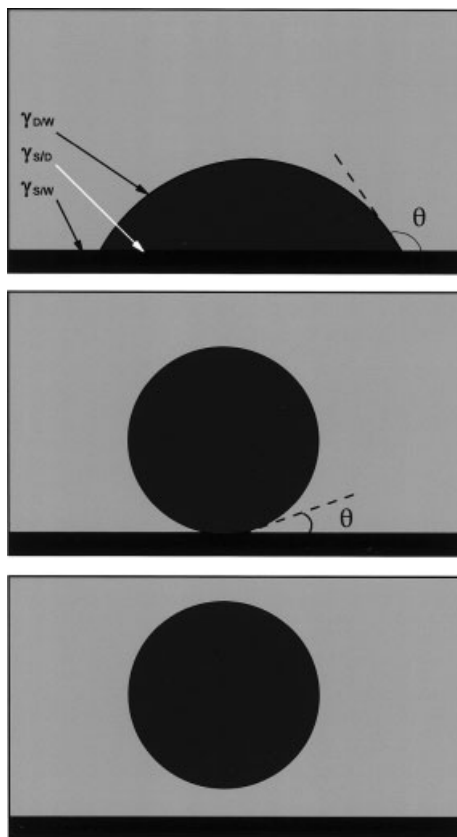


Figure 3.27 Illustration of detergency.

Since detergents should adsorb at the solid–water and dirt–water interfaces, but not the air–water surface, the latter action, which causes foaming (“suds”), is not an indication of detergent effectiveness (product advertising campaigns notwithstanding). In fact, in commercial washing foams are troublesome and need to be avoided. The adsorption of detergent at the solid–water and dirt–water interfaces helps prevent re-deposition of the dirt by maintaining the new interfacial energy states, and (for ionic surfactants) by creating an electrostatic barrier. The amount of surfactant adsorption is determined by the free surfactant concentration – which may be limited by the presence of micelles. On the other hand, micelles provide a reservoir from which free surfactant can be replenished, and for solubilizing greases and oils. Finally, detergents cannot work by themselves in practical situations; the business of detergent additives is huge. Common additives include builders (agents that enhance the detergent action), anti-redeposition agents, brighteners, and co-surfactants.

It is sometimes desirable to have surfactants that can act as biocides as well, especially in cleaning and sanitizing applications. Some cationic surfactants are toxic to bacteria, fungi, and algae. The most common biocidal surfactants have quaternary ammonium polar groups, ranging from quaternary amines to amine oxides.

## 3.7

**Other Lyophilic Colloids: Microemulsions**

Microemulsions, like micelles, are considered to be lyophilic, stable, colloidal dispersions. In some systems the addition of a fourth component, a co-surfactant, to an oil/water/surfactant system can cause the interfacial tension to drop to near-zero values, easily on the order of  $10^{-3} - 10^{-4}$  mN/m, allowing spontaneous or nearly spontaneous emulsification to very small drop sizes, typically about 10–100 nm, or smaller [223]. The droplets can be so small that they scatter little light, so the emulsions appear to be transparent. Unlike coarse emulsions, microemulsions are thought to be thermodynamically stable: they do not break on standing or centrifuging. The thermodynamic stability is frequently attributed to a combination of ultra-low interfacial tensions, interfacial turbulence, and possibly transient negative interfacial tensions, but this remains an area of continued research [224,225].

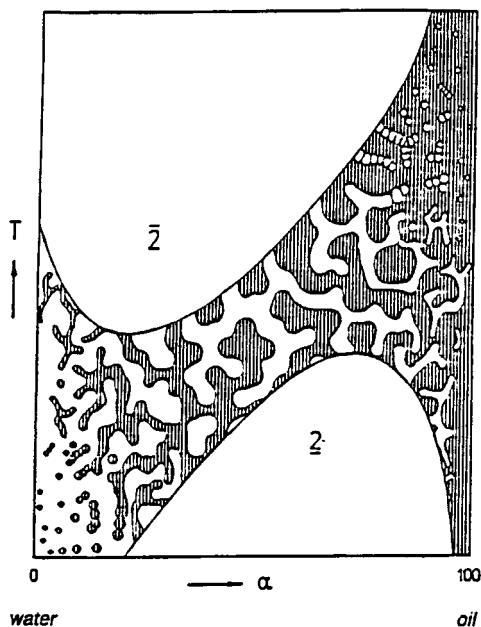
The Winsor microemulsion classification system distinguishes among three different types based on their phase behaviour:

- Type I O/W microemulsions, in which the oil is solubilized within micelles in an aqueous continuous phase.
- Type II W/O microemulsions, in which the aqueous phase is solubilized within micelles in an oleic continuous phase.
- Type III microemulsions, in which the aqueous and oleic phases are in equilibrium with a third, surfactant-rich, phase called the middle-phase microemulsion, which can contain bi-continuous emulsion. This is illustrated in Figure 3.28 [226].

For a given chemical system, phase-type diagrams can be constructed that show the regimes in which each type of microemulsion will exist [227,228]. These can be used to understand and predict the effects of, for example, increasing salinity or decreasing HLB, which tend to shift the emulsion type directionally from type I to type III to type II. Type III microemulsions can be thought of as bi-continuous, as opposed to drop-like or lamellar. It is thought that phase inversion from a water-in-oil microemulsion to an oil-in-water microemulsion takes place by transition through a bi-continuous structure in which the aqueous and oleic phases are mutually intertwined. This transition has been graphically illustrated by Burauer *et al.* [72] using freeze-fracture scanning electron microscopy.

Much work has also gone into understanding the chemical composition requirements for microemulsification [229]. For example, surfactants having extended hydrocarbon tails (linkers) have been developed to induce additional orienting of oleic phase molecules at depth from the interfaces [230,231]. Table 11.3 gives some idea of the range of components that may be formulated into a microemulsion.

Microemulsion system applications span many areas including enhanced oil recovery, soil and aquifer decontamination and remediation, foods, pharmaceuticals (drug delivery systems), cosmetics, and pesticides [2,5,33,37,232,233]. Some of these are listed in Table 3.6. The widespread interest in microemulsions and use in these different industrial applications are based mainly on their high solubilization capac-



**Figure 3.28** Illustrative section from the phase prism of a mixture of oil, water, and surfactant. This section is for constant surfactant concentration ( $T$  is temperature). The section shows a middle-phase microemulsion phase existing together with oil (upper) and water (lower) phases. The surfactant is partitioned among all of the phases. The cross-hatching shows how the microemulsion can be O/W (to the left), or W/O (to the right), or bicontinuous (centre). From Schwuger *et al.* [226]. Copyright 1995, American Chemical Society.

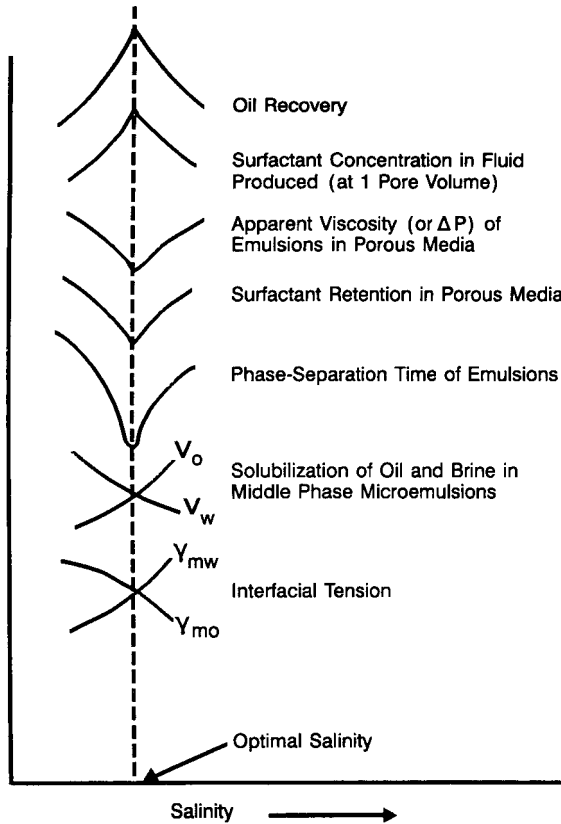
ity for both hydrophilic and lipophilic compounds, their large interfacial areas, the ultra-low interfacial tensions achieved when they coexist with excess aqueous and oil phases, and their long-term stability.

**Table 3.6** Some application areas for microemulsions.

Technology	Section
Enhanced oil recovery processes	11.2
Metalworking oils	12.4
High-performance coatings	12.6
Flavoured, clear mouthwashes and beverages	13.8
Microencapsulated agrochemicals	13.10
Intramuscular drugs	14.3
Intravenous drugs and nutrients	14.3
Cosmetic skin care products	15.3
Nanoparticle preparation media	16.1

**Example.** Microemulsions can form the basis for an enhanced oil recovery (EOR) process. In an oil-containing reservoir the oil is distributed among pores in the rock. In a water-wet reservoir, the largest pores will retain high oil contents. As water is injected, the pressure increases and the larger pores will imbibe more water, displacing oil which may be recovered at producing wells. Beyond the practical limit to which water pressure can be applied, a large amount of residual oil will still be left in the form of oil ganglia trapped in the larger pores by capillary forces. One way to overcome the capillary forces is to add a suitable surfactant and cosurfactant to the water so that the oil is emulsified, into a microemulsion, and released from the pores. Microemulsions for enhanced oil recovery are discussed in more detail in Section 11.2.

In using microemulsions to enhance oil recovery from petroleum reservoirs (see Section 11.2.2) the concept of optimal salinity has evolved. By optimal salinity is meant the salinity for which O/W interfacial tension is lowest and oil recovery is



**Figure 3.29** Illustrations of changes occurring in physical properties and other phenomena in the region of the optimal salinity for enhanced oil recovery using surfactant flooding. From Sharma [235]. Copyright 1991, Plenum Press.

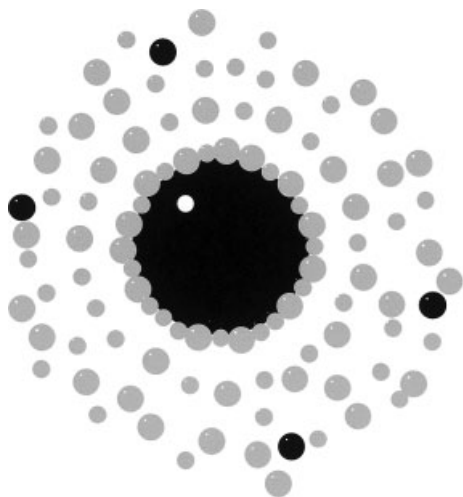
maximized [234]. The variation of other properties when approaching the optimal salinity point is shown in Figure 3.29 [234,235]. Several reviews summarize other such trends [227,228].

Solubilization in micelles can provide a means of delivering otherwise insoluble drugs or improving the transport of agrochemicals across plant membranes. Some ways in which a substrate can be solubilized by a microemulsion include [236]:

- direct solubilization of a lipophilic substrate into a hydrocarbon core, or vice versa,
- co-micellization of a surfactant substrate in between the primary surfactant chains in the palisade layer of the micelle, and,
- by adsorption of a substrate on the surface of a micelle.

The properties of microemulsions have been extensively reviewed elsewhere [33,229,237–245].

## 4

**Electrokinetics**

**Figure 4.1** Illustration of a charged colloidal particle or droplet with adsorbed and diffuse layers of counterions.

## 4.1

**Charged Interfaces**

Most substances acquire a surface electric charge when brought into contact with a polar medium such as water. The origin of the charge can be:

- Ionization, such as the ionization of carboxyl and/or amino functionalities when proteins are put into water (pH dependent).
- Ion adsorption, such as when surfactant ions adsorb onto a solid surface.
- Ion dissolution, such as in the salt type minerals when, for example,  $\text{Ag}^+$  and  $\text{I}^-$  dissolve unequally when AgI is placed in water.
- Ion diffusion, such as when a clay particle, having internal crystal structure that carries an opposite charge due to isomorphous substitution, is placed in water and its counter-ions diffuse out to form an electric double layer.

**Example.** The surfaces of dispersed AgI particles can be considered similarly to an Ag-AgI-aqueous solution reversible electrode (i.e., each phase contains a common ion that can cross the interface). Here both  $\text{Ag}^+$  and  $\text{I}^-$  will be potential determining ions because either may adsorb at the interface and change the surface potential. In this case,  $\text{NaNO}_3$  is an example of an indifferent electrolyte as far as the electrode potential goes.

For AgI,  $K_{\text{SP}} = 7.5 \times 10^{-17}$  at 25 °C. The equilibrium concentration of either ion at saturation is then  $8.7 \times 10^{-9}\text{M}$ . Under these conditions the AgI surface is negatively charged because the  $\text{I}^-$  ions have a greater affinity for the surface than do the  $\text{Ag}^+$  ions. If  $\text{AgNO}_3$  is added to the solution it is found that at a concentration of  $3.0 \times 10^{-6}\text{M}$  the surface charge becomes just zero (this is the zero point of charge), and at higher concentrations the surface becomes positively charged. The Nernst equation gives the surface potential in terms of changing concentrations of either  $\text{Ag}^+$  or  $\text{I}^-$  as:

$$\psi^\circ = (kT/e) \ln (c/c_{\text{zp}}) = (2.303RT/F) \log (c/c_{\text{zp}})$$

where  $c_{\text{zp}}$  is the concentration of ion at the zero point of charge. Now for AgI in pure water we have  $c_{\text{Ag}} = 8.7 \times 10^{-9}\text{M}$  and  $c_{\text{Ag,zp}} = 3.0 \times 10^{-6}\text{M}$  so  $\psi^\circ = -150\text{mV}$  (negative as described earlier). Changes in electrode potential will be given by  $d\psi^\circ = (kT/e) (dc/c)$  so that potential changes can be related to concentration changes. This equation can be integrated back to the earlier Nernst equation if the boundary equation  $\psi^\circ = 0$  at  $c = c_{\text{zp}}$  is known.

In a practical emulsion situation, the degree of surface charging may be more complicated than this. An example is the bitumen–water interface, which becomes negatively charged in alkaline aqueous solutions due to the ionization of surface carboxylic acid groups belonging to natural surfactants present in the bitumen. The degree of negative charging is very important to *in situ* oil sands bitumen recovery processes, surface oil sands separation processes [246–250], and also to the formulation of asphalt emulsions for road paving. The degree of negative charge at the interface depends on the pH and ionic strength of the solution [246,247] and also on the concentration of natural surfactant monomers present in the aqueous phase [248,249]. With bitumen, as with other heavy crudes, more than one kind of surfactant may be produced [250] and the solution concentrations of the surfactants depend also on reaction conditions (temperature, etc.) and on the extent of competing reactions such as the adsorption of the surfactants onto solid (clay) particles that are present as well [251,252].

Surface charge influences the distribution of nearby ions in a polar medium: ions of opposite charge (counter-ions) are attracted to the surface while those of like charge (co-ions) are repelled. Together with mixing caused by thermal motion, a diffuse electric double layer is formed.

## 4.2

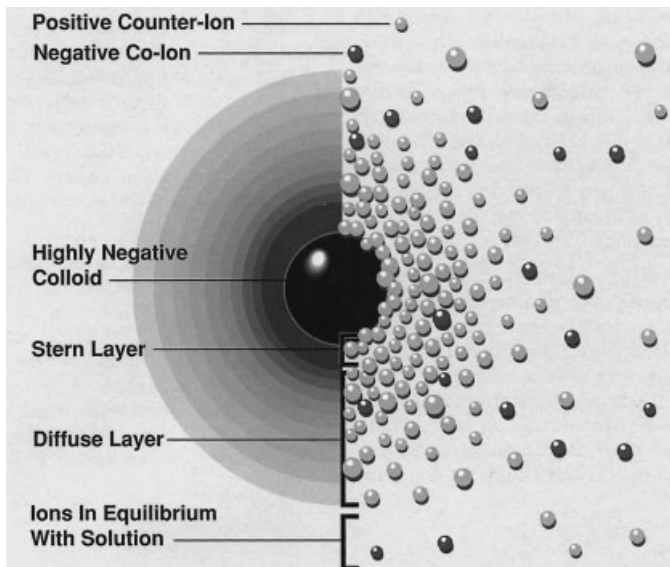
**Electric Double Layer**

The electric double layer (EDL) consists of the charged surface and the neutralizing excess of counter-ions over co-ions, distributed near the surface. The EDL can be viewed as being composed of two layers: an inner layer that may include adsorbed ions and a diffuse layer where ions are distributed according to the influence of electrical forces and thermal motion (Figure 4.2). Gouy and Chapman proposed a simple quantitative model for the diffuse double layer assuming an infinite, flat, uniformly charged surface, and ions that can be regarded as point charges (also that solvent effects arise only through a uniform dielectric constant, and that the electrolyte is symmetrical [z-z]).

Taking the surface potential to be  $\psi^0$ , the potential at a distance  $x$  as  $\psi$ , and combining the Boltzmann distribution of concentrations of ions in terms of potential, the charge density at each potential in terms of the concentration of ions, and the Poisson equation describing the variation in potential with distance, yields the Poisson–Boltzmann equation. Given the physical boundary conditions, assuming low surface potentials, and using the Debye–Hückel approximation, yields

$$d^2\psi/dx^2 = [e^2\psi/(\epsilon kT)] \sum_i c_i z_i^2 \quad (4.1)$$

If we now define the cluster of constants as  $\kappa^2 = (e^2/\epsilon kT) \sum_i c_i z_i^2$  (having units of distance<sup>-2</sup>) then this can be simplified to:



**Figure 4.2** Illustration of the diffuse electric double layer showing the distributions of counter- and co-ions. Courtesy L.A.

Ravina, Zeta-Meter, Inc., Staunton, Va.



$$d^2\psi/dx^2 = \kappa^2\psi$$

or,

$$\psi = \psi^\circ \exp(-\kappa x) \quad (4.2)$$

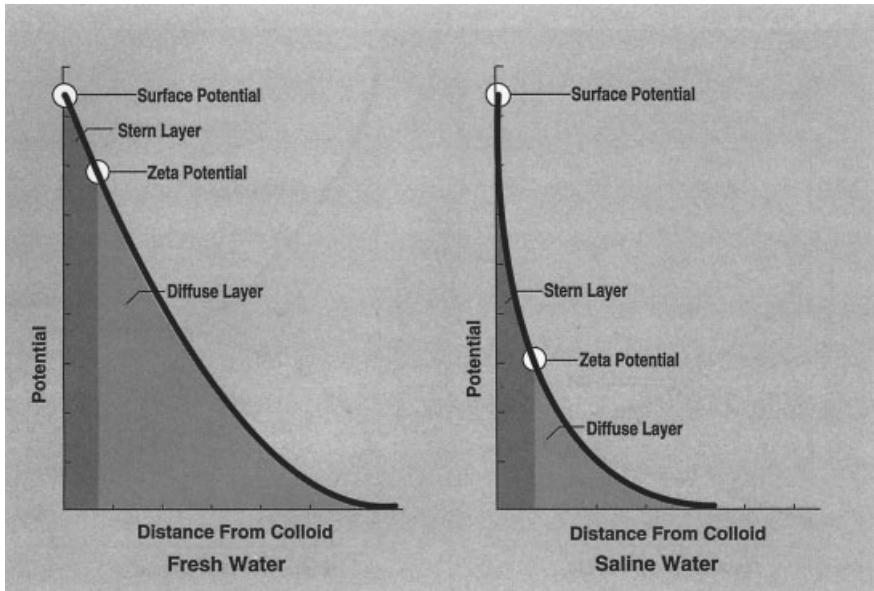
This is the Debye–Hückel expression for the potential at a distance from a charged surface. The exponential decay is illustrated in Figure 4.3. The surface charge density is:

$$\sigma^\circ = \epsilon\kappa\psi^\circ \quad (4.3)$$

where  $\epsilon$  is the permittivity, thus  $\psi^\circ$  depends on surface charge density and the solution ionic composition (through  $\kappa$ ).  $1/\kappa$  is called the double layer thickness and is given for water at 25 °C by:

$$\kappa = 3.288 \sqrt{I} \text{ (nm}^{-1}\text{)} \quad (4.4)$$

where  $I = (1/2) \sum_i c_i z_i^2$ . For 1-1 electrolyte,  $1/\kappa$  is 1 nm for  $I = 10^{-1}$  M, and 10 nm for  $I = 10^{-3}$  M. At a distance  $1/\kappa$  from the charged surface the potential is reduced to  $\psi^\circ/e$ . At a distance  $3/\kappa$  from the charged surface the potential is reduced to about 2% of  $\psi^\circ$ .



**Figure 4.3** Illustration of the diffuse electric double layer showing the decay of potential away from the surface. Courtesy L.A. Ravina, Zeta-Meter, Inc., Staunton, Va.

There remain some problems. In order to handle higher (more practical) potentials, the Gouy–Chapman theory can be applied, but with a more complicated result. One such result is:

$$\gamma = \gamma^{\circ} \exp(-\kappa x) \quad (4.5)$$

where  $\gamma$  is a complex ratio involving  $\psi$ , given by:

$$\gamma = \{ \exp [ze \psi / 2kT] - 1 \} / \{ \exp [ze \psi / 2kT] + 1 \} \quad (4.6)$$

At low surface potentials Eq. (5.5) reduces to Eq. (5.2). Secondly, an inner layer exists because ions are not really point charges and an ion can only approach a surface to the extent allowed by its hydration sphere. The Stern model specifically incorporates a layer of specifically adsorbed ions bounded by a plane termed the Stern plane (see Figure 4.3). In this case the potential changes from  $\psi^{\circ}$  at the surface, to  $\psi(\delta)$  at the Stern plane, to  $\psi = 0$  in bulk solution.

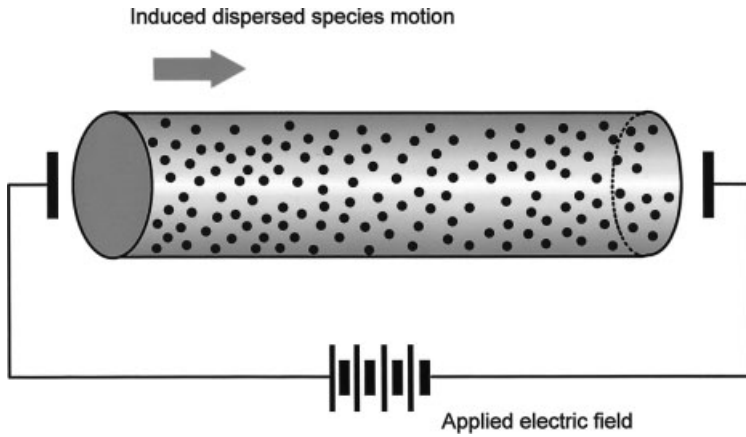
Electric double layers can be present at the gas/liquid interfaces between bubbles in foams. In this case, since the interfaces on each side of the thin film are equivalent, any interfacial charge will be equally carried on each side of the film. If a foam film is stabilized by ionic surfactants then their presence at the interfaces will induce a repulsive force opposing the thinning process. The magnitude of the force will depend on the charge density and the film thickness.

### 4.3

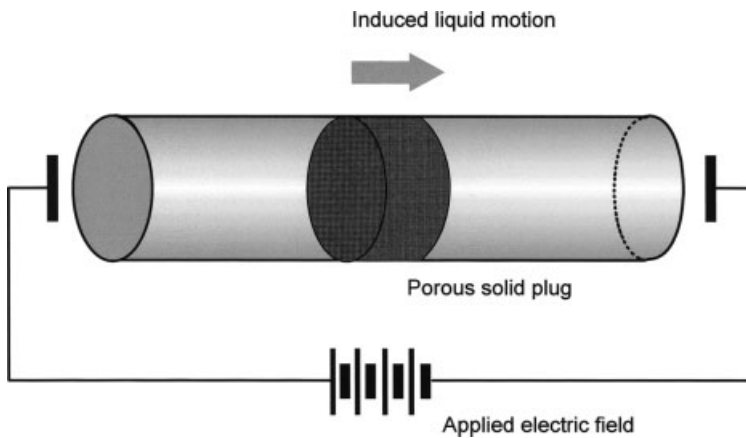
#### Electrokinetic Phenomena

Electrokinetic motion occurs when the mobile part of the electric double layer is sheared away from the inner layer (charged surface). There are several types of electrokinetic measurements:

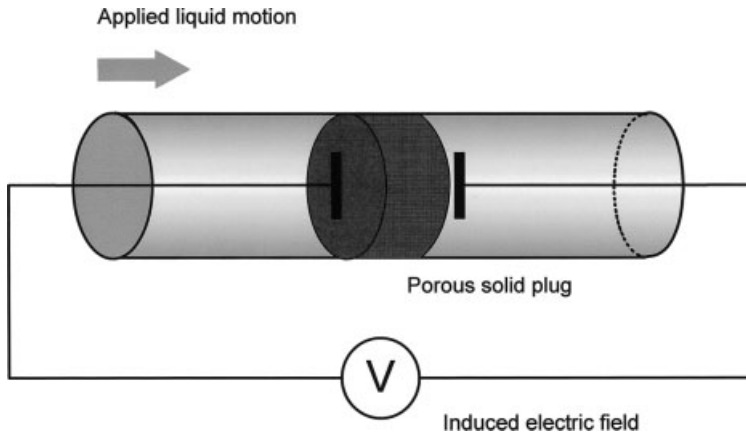
- **Electrophoresis**, in which an electric field is applied causing dispersed species, with their charged surfaces plus some attached fluid, to move relative to stationary liquid (Figure 4.4).
- **Electro-osmosis**, in which an electric field is applied causing mobile liquid to move relative to a stationary charged surface (Figure 4.5).
- **Streaming potential**, in which liquid is made to flow along a stationary charged surface creating an electric field (Figure 4.6).
- **Sedimentation potential**, in which charged species are made to move relative to stationary liquid creating an electric field (Figure 4.7).
- **Ultrasonic Vibration Potential (UVP)**, an electroacoustical method involving detection of the alternating electric field (potential or current) generated when dispersed species are made to move by imposed sound waves (Figure 4.8). This technique is also referred to as colloid vibration potential (CVP), or colloid vibration current (CVC).



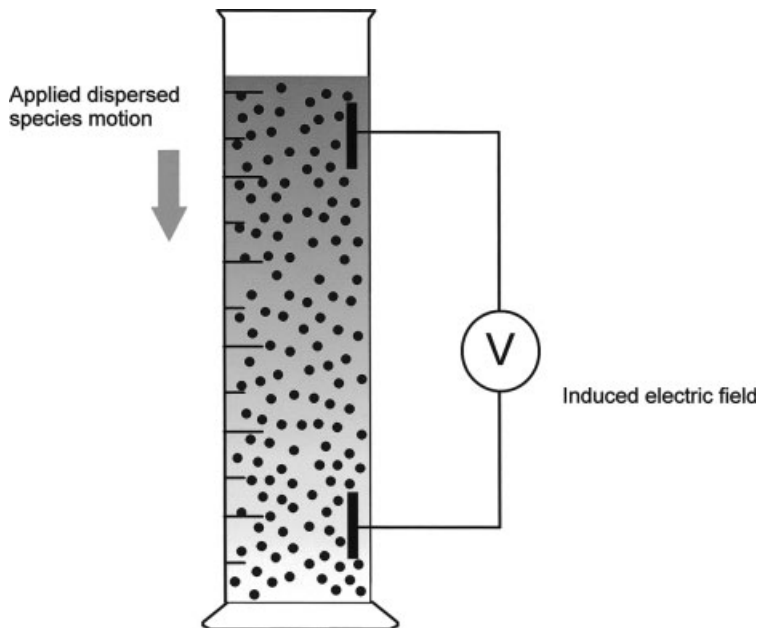
**Figure 4.4** Illustration of the principle of electrophoresis, in which an electric field is applied causing dispersed species, with their charged surfaces plus some attached fluid, to move relative to stationary liquid.



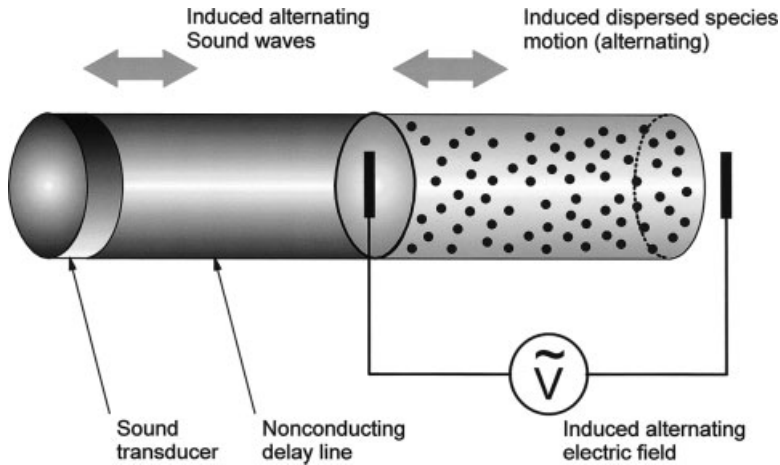
**Figure 4.5** Electro-osmosis, in which an electric field is applied causing mobile liquid to move relative to a stationary charged surface.



**Figure 4.6** Streaming potential, in which liquid is made to flow along a stationary charged surface creating an electric field.



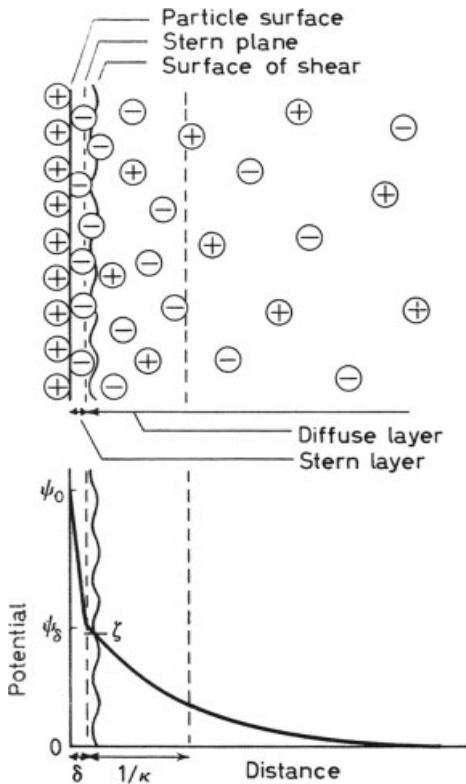
**Figure 4.7** Sedimentation potential, in which charged species are made to move relative to stationary liquid creating an electric field.



**Figure 4.8** Ultrasonic Vibration Potential (UVP), an electroacoustical method involving detection of the alternating electric field generated when dispersed species are made to move by imposed alternating sound waves.

- **Electrokinetic sonic amplitude (ESA, also termed electrosonic amplitude)**, an electroacoustical method involving detection of the sound wave generated when dispersed species are made to move (oscillate) by an imposed alternating electric field (the principal features of the technique are shown in Figure 4.8, the difference being in the measurement of electrical potential rather than sound wave amplitude). The sound wave moves along a delay rod to a transducer, which is induced to vibrate. By measuring the amplitude of that sound wave over a range of frequencies one can calculate the mobility, hence the zeta potential.

The first four methods are described in Refs. [81,253,254] and the electroacoustical methods in [130,255–257]. Of these, electrophoresis finds the most use in industrial practice. The electroacoustic methods are perhaps the best suited to studying concentrated suspensions and emulsions without dilution [258]. In all of the electrokinetic measurements, either liquid is made to move across a solid surface or vice versa. Thus the results can only be interpreted in terms of charge density ( $\sigma$ ) or potential (zeta potential,  $\zeta$ ) at the plane of shear. The location of the shear plane is generally not exactly known and is usually taken to be approximately equal to the potential at the Stern plane,  $\zeta \approx \psi(\delta)$ , see Figure 4.9. Several methods can be used to calculate zeta potentials [16,81,253]. Some of these will be discussed here, in the context of electrophoresis results.



**Figure 4.9** Schematic representation of the positions of the Stern plane and the Zeta potential in the electric double layer. From Shaw [60]. Copyright 1966, Butterworths.

#### 4.3.1

### Electrophoresis

Microelectrophoresis is the most common technique for electrokinetic measurements in colloidal systems. Here individual particles can be observed, in their normal environment, under the microscope. Very dilute dispersions can be studied and very small particles, down to about  $0.1 \mu\text{m}$  diameter, can be observed using the dark-field microscope (ultramicroscope). High magnifications allow minimization of observation times, and in polydisperse systems a given size range of particles can be studied to the exclusion of others.

In electrophoresis an electric field is applied to a sample causing charged dispersed droplets, bubbles, or particles, and any attached material or liquid to move towards the oppositely charged electrode. Their electrophoretic velocity is measured at a location in the sample cell where the electric field gradient is known. This has to be done at carefully selected planes within the cell because the cell walls become charged as well, causing electro-osmotic flow of the bulk liquid inside the cell. From hydrodynamics it is found that there are planes in the cell where the net flow of bulk liquid is zero, the stationary levels, at which the true electrophoretic velocity of the particles can be measured.

Good descriptions of practical experimental techniques in conventional electrophoresis can be found in Refs. [81,253,259]. For the most part, these techniques are applied to suspensions and emulsions, rather than foams. Even for foams, an indirect way to obtain information about the potential at foam lamella interfaces is by bubble electrophoresis. In bubble microelectrophoresis the dispersed bubbles are viewed under a microscope and their electrophoretic velocity is measured taking the horizontal component of motion, since bubbles rapidly float upwards in the electrophoresis cells [260,261]. A variation on this technique is the spinning cylinder method, in which a bubble is held in a cylindrical cell that is spinning about its long axis (see [262] and p.163 in Ref. [44]). Other electrokinetic techniques, such as the measurement of sedimentation potential [263] have also been used.

The electrophoretic mobility,  $\mu_E$  is defined as the electrophoretic velocity divided by the electric field gradient at the location where the velocity was measured:

$$\mu_E = (\text{electrophoretic velocity}) / (\text{electric field gradient}) \quad (4.7)$$

A change in electrophoretic mobility reflects a change in one or more of the following:

- changing the surface charge,
- changing the Stern layer charge,
- changing the diffuse layer charge,
- changing surface hydration.

Thus, in practical systems electrokinetic results are often amenable only to qualitative interpretation.

As stated above, the results can be interpreted in terms of potential at the plane of shear, termed the zeta potential ( $\zeta$ ). Since the exact location of the shear plane is generally not known, the zeta potential is usually taken to be approximately equal to the potential at the Stern plane. Two simple relations can be used to calculate zeta potentials in limiting cases, one for small particles with “thick” electric double layers, and one for large particles with “thin” electric double layers.

#### Hückel Theory

For particles of small radius,  $a$ , with “thick” electric double layers, meaning that  $\kappa a < 1$ , it is assumed that Stokes’ law applies and the electrical force is equated to the frictional resistance of the particle,

$$\mu_E = \zeta \varepsilon / (1.5 \eta) \quad (4.8)$$

#### Smoluchowski Theory

For large particles with “thin” electric double layers, meaning particles for which  $\kappa a > 100$ . This theory takes account of the opposite effect of the applied electric field on the ions in the electric double layer, an effect called electrophoretic retardation which acts to reduce particle velocity,

$$\mu_E = \zeta \varepsilon / \eta \quad (4.9)$$

With these relations, zeta potentials can be calculated for many practical systems. Note that within each set of limiting conditions the electrophoretic mobility is independent of particle size and shape as long as the zeta potential is constant. For intermediate values of  $\kappa a$  another equation, the Henry equation (4.10) can be used; other such equations are available in the literature as well [81,253,264].

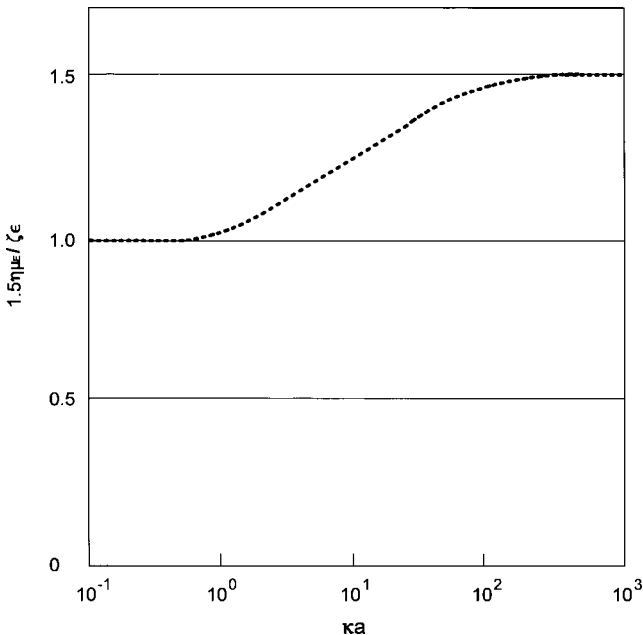
### Henry Theory

Equations (4.8) and (4.9) differ by a factor of 1.5 in the denominator because the Hückel theory assumes that the charged particle has no influence on the local applied field, while Smoluchowski theory assumes that the applied field is uniform and parallel to the particle surface. Henry theory covers the transition from  $\kappa a < 1$  (Hückel theory) to  $\kappa a > 100$  (Smoluchowski theory) by taking account of both frictional force and electrophoretic retardation,

$$\mu_E = \zeta \epsilon f_1 / (1.5\eta) \quad (4.10)$$

where  $f_1$  is a function of  $\kappa a$  and also of particle shape and takes values between 1.00 and 1.50 as shown in Figure 4.10.

There remain some experimental problems. Since the conductivity of the mobile electric double layer region is higher than in bulk solution, the surface conductance alters the electric field distribution somewhat, hence the zeta potential. This is usually not significant for small values of  $\kappa a$  and/or ionic strengths greater than about 0.01 M. In the presence of the applied electric field, the electric double layer



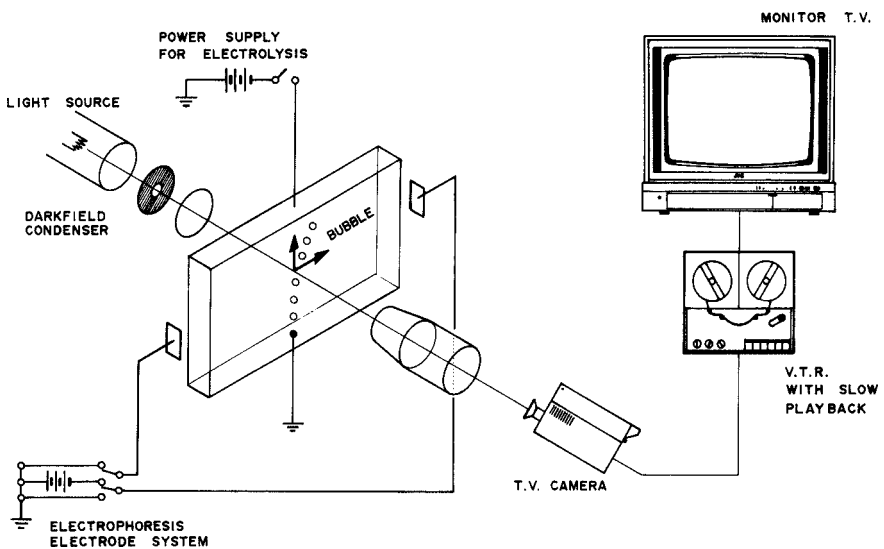
**Figure 4.10** Illustration of the Henry equation parameter with  $\kappa a$ . From data in Shaw [60].



ions move in opposition to the motion of the dispersed species. This produces an opposing local flow of liquid which causes an electrophoretic retardation effect (accounted for by the Henry equation above). Also, the movement of the dispersed species distorts the electric double layer and some time is needed to restore symmetry, a relaxation time. The asymmetrical mobile part of the electric double layer contributes a retarding force. The reduction in electrophoretic mobility that results is called the electrophoretic relaxation effect (note that this is different from the electrophoretic retardation which is accounted for by the Henry equation).

While the measurement of electrophoretic mobilities in suspensions and emulsions is very common, it is also possible to apply electrophoresis to dispersed bubbles. In one method, bubbles of either hydrogen or oxygen are generated within the electrophoresis cell, by electrolysis, using electrodes placed to ensure that bubbles will rise in one of the cells stationary levels. With these bubbles rising in the cell, the normal electric field gradient for electrophoresis is applied, and any electrophoretic motion is imaged using high-speed image recording (see Figure 4.11). It is of interest to note that several studies (e.g., Huddleston and Smith, p. 163 in Ref. [44]) have shown that gas bubbles in water of neutral pH tend to adopt a negative surface charge even in the absence of surfactants.

Electrophoresis can also be conducted on-line, as an element of industrial process monitoring and/or control. In this case a slip-stream sample is usually withdrawn from a process vessel, diluted in a mixing tank to reduce the sample turbidity, and then pumped through an electrophoresis cell that is fitted with stop-flow solenoid valves. The flow is stopped for long enough to make an electrophoresis measurement and then resumed. The sampling can be either intermittent or continuous. An example is described in reference [265]).



**Figure 4.11** Illustration of an electrophoresis system for the study of bubbles, which are generated by the electrolysis of water.

## 4.3.2

**Point of Zero Charge and Isoelectric Point**

Potential-determining ions are those whose equilibrium between two phases, frequently between an aqueous solution and an interface, determines the difference in electrical potential between the phases. Consider a AgI dispersion in water. There will exist some concentrations of  $\text{Ag}^+$  and  $\text{I}^-$  such that the surface charge of the AgI particles is zero. This is called the point of zero charge (pzc). It is usually determined by a titration method (called a colloid titration).

A more complicated example could be an aqueous dispersion of particles which contain both surface carboxylate groups and surface quaternary amine groups. Some minerals contain positive, neutral, and negative charge groups on their surfaces. For example, the clay minerals may have negative charges arising within their lattice structures, plus negatively and/or positively charged groups on their particle surfaces [1]. While some charges arise from crystallographic structure, others are a function of solution pH. Therefore, in these cases, there may be a solution pH condition for which the particle zeta potential is zero, called the isoelectric point (iep), even though the surfaces may still contain a variety of discrete charged groups. Isoelectric points for a number of common minerals are shown in Table 4.1. Additional values are given elsewhere [1,49]. For many minerals there is a range of isoelectric point values, rather than a single value, due to variations in crystallinity, surface properties, and extents of surface hydration. Somasundaran provides an example of such variations for alumina [266]. Also, any specific adsorption of cations or anions, or any incongruent dissolution of the minerals, will result in changes to the iep values.

**Table 4.1** Isoelectric points for selected minerals\*.

Mineral	Formula	Isoelectric pH
Quartz	$\text{SiO}_2$	1.9–2.2
Pyrite	$\text{FeS}_2$	2.0
Sphalerite	$\text{ZnS}$	2.0–2.3
Limonite	$\text{FeO}(\text{OH})$	3.6
Rutile	$\text{TiO}_2$	4.0–4.7
Magnesium dioxide	$\text{MnO}_2$	4.2
Gibbsite	$\alpha\text{-Al}(\text{OH})_3$	5.0
Magnemite	$\gamma\text{-Fe}_2\text{O}_3$	6.7
Hydroxyapatite	$\text{Ca}_5(\text{PO}_4)_3(\text{OH})$	7.0
Amorphous ferric hydroxide	$\text{Fe}(\text{OH})_3$	7.1–8.5
Anthracite		8.1
Calcite	$\text{CaCO}_3$	9.5
Chrysotile	$\text{Mg}_3\text{Si}_2\text{O}_5(\text{OH})_8$	10.5
Magnesium oxide	$\text{MgO}$	12.4

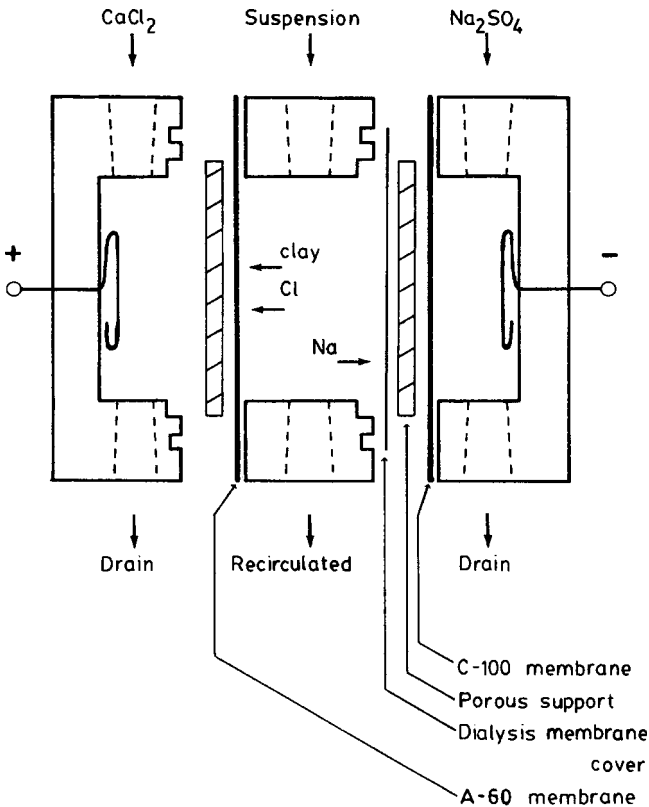
\* From [49,91].

## 4.3.3

**Electrodialysis**

Electrodialysis involves the application of an electric field to a colloidal dispersion that has been placed in a chamber arranged so that one or both electrodes are separated from the dispersion by semi-permeable membrane(s). Typically, dissolved ions can flow through the membrane(s) in response to the electric field gradient, while the dispersed particles (or other species) are restrained within the chamber.

**Example.** Electrodialysis has been used to purify clay suspensions from electrolyte impurities. It has also been used to prepare homoionic clay particle surfaces, although the only form that can be prepared in this manner is that having protons as the exchangeable ions, i.e., H-clays. Figure 4.12 provides a schematic illustration. This can be problematic in that preparing H-form clays can lead to dissolution of the clay lattice itself [267].



**Figure 4.12** Batch electrodesalting apparatus. From Schramm [55]. Copyright 1980, Laurier L. Schramm.

#### 4.4

#### Electrostatic Properties in Non-aqueous Media

Although suspensions most commonly comprise particles dispersed in aqueous media it sometimes happens that particles are dispersed in non-aqueous media. Examples include particulate contaminants in liquid fuels or lubricating oils [268], precipitated asphaltenes in crude oil [269] and mineral solids dispersed in diluted froth in oil sands processing [270]. Particles can be electrostatically stabilized in non-aqueous media although the charging mechanism is different [7,268]. The review by Morrison [268] emphasizes that there are many models available for the behaviour of electrical charges in non-aqueous media, but that few are universally accepted. The particles may acquire their charge by adsorption of ions, or through the dissociation of ions from their surfaces. In one model of non-aqueous electrolyte solutions, the ions are considered to be held in large structures such as micelles that prevent their being neutralized. The electric field, its concentration dependence, and the electrical conductivity are then determined by the size, structure, and motions of these micelles.

In the petroleum industry, flammable vapours are often present so both fire and explosion hazards exist. The conductivity of petroleum fluids is low, which allows the build-up of large potential gradients. The interaction of impurities in the petroleum fluids with pipe and tank walls apparently allows the generation of electrical charges (there is also a role for emulsified water droplets). The flow of the fluid in a tank or pipe allows the separation of charges and can cause sufficient charging for there to be an electrostatic discharge which in turn can cause an explosion. According to Morrison [268] appropriate safety precautions include keeping all containers and pipes electrically connected, increasing the electrical conductivity of the petroleum fluid by adding non-aqueous electrolytes, and keeping the environment free of oxygen.

The role of electrostatic repulsion in the stability of suspensions of particles in non-aqueous media is not yet clear. In order to attempt to apply theories such as the DLVO theory (to be introduced in Section 5.2) one must know the electrical potential at the surface, the Hamaker constant, and the ionic strength to be used for the non-aqueous medium; these are difficult to estimate. The ionic strength will be low so the electric double layer will be thick, the electric potential will vary slowly with separation distance, and so will the net electric potential as the double layers overlap. For this reason the repulsion between particles can be expected to be weak. A summary of work on the applicability or lack of applicability of DLVO theory to non-aqueous media has been given by Morrison [268].



## 5

**Colloid Stability**

Lyophobic dispersions are not thermodynamically stable. Rather they possess some degree of kinetic stability, and one must consider such things as what degree of change and over what time scale. The dispersed species can come together in very different ways.

**Sedimentation**, or creaming, results from a density difference between the dispersed and continuous phases. This is not yet a destabilization of the dispersion, but produces two separate layers of dispersion that have different dispersed phase concentrations. One of the layers will contain an enhanced concentration of dispersed phase, which may promote aggregation. (The term creaming comes from the familiar separation of cream from raw milk.)

**Aggregation** is when two or more dispersed species clump together, possibly touching at some points, and with virtually no change in total surface area. Aggregation is sometimes referred to as flocculation or coagulation but, for suspensions, coagulation and flocculation are frequently taken to represent two different kinds of aggregation. In this case coagulation refers to the formation of compact aggregates, whereas flocculation refers to the formation of a loose network of particles, linked through particles' edge–edge and edge–face interactions (see the discussion in Section 5.6.2). Thus, in montmorillonite clay suspensions, coagulation refers to dense aggregates produced by face–face oriented particle associations, and flocculation refers to loose aggregates produced by edge–face or edge–edge oriented particle associations<sup>1)</sup> (see Figure 1.7). The coagulation of dissimilar species is called heterocoagulation (or mutual coagulation).

**Coalescence** is when two or more particles, droplets or bubbles fuse together to form a single larger unit, reducing the total surface area.

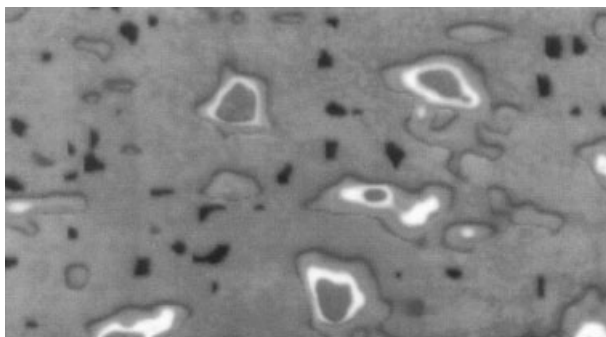
In aggregation the species retain their identity but lose their kinetic independence since the aggregate moves as a single unit. Aggregation of droplets may lead to coalescence and the formation of larger droplets until the phases become separated. In coalescence, on the other hand, the original species lose their identity and become part of a new species. Kinetic stability can thus have different meanings. An

1) Conversely, the dissociation of edge–face and edge–edge linked particles would be termed deflocculation.

emulsion can be kinetically stable with respect to coalescence, but unstable with respect to aggregation. A suspension could be kinetically stable with respect to aggregation, but unstable with respect to sedimentation or flotation. Encounters between dispersed species can occur frequently due to any of diffusion (as in Brownian motion), sedimentation, or stirring. The stability of the dispersion to aggregation and coalescence depends on how the dispersed species interact when this happens.

Although most colloidal dispersions are not thermodynamically stable, a consequence of the small size and large surface area in colloids, and of the presence of an interfacial film on droplets, bubbles or particles, is that dispersions of these species, having reasonable kinetic stability, can be made. That is, suspended droplets or particles may not aggregate quickly nor settle or float out rapidly and droplets in an emulsion or bubbles in a foam may not coalesce quickly. Many food and personal care product emulsions and suspensions, for example, are formulated to remain stable for months to years. It is crucial that stability be understood in terms of a clearly defined process, and one must consider the degree of change and the time-scale in the definition of stability.

In practical terms emulsions, foams, and suspensions may be stable enough to persist for days, months or even years and may resist explicit demulsification, anti-foaming, defoaming, and aggregation treatments. Figure 5.1 shows a magnetic resonance imaging (MRI) slice taken through the centre of an emulsion sample which one of the authors (LLS) had collected from an oil/water separating plant, and then stored for more than five years before this image was taken. The continuous phase is oil, and one can clearly observe still dispersed oil-in-water-in-oil (O/W/O) and water-in-oil (W/O) droplets. The angular, rather than spherical, shapes suggest the presence of viscoelastic interfacial films surrounding these droplets. Foams can also have long lifetimes. Although the drainage half-life of a typical foam is of the order of tens of minutes, some foams can have much greater stability. In carefully con-



**Figure 5.1** Reconstructed image from a magnetic resonance imaging (MRI) slice taken through the centre of an emulsion sample which had been collected from an oil/water separating plant, and then stored for more than 5 years before this image was taken. Aqueous films are shown in white, oil in grey, and solids in black. The larger oil-in-water-in-oil emulsion droplets are about 150  $\mu\text{m}$  in diameter.

trolled environments, it has been possible to make surfactant-stabilized foam bubbles and films having lifetimes of from months to years [45].

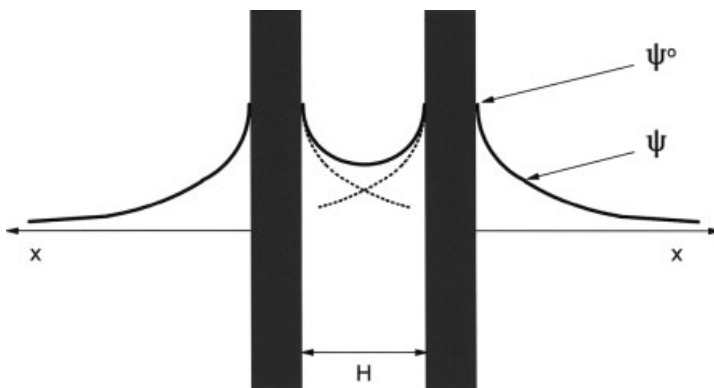
In this discussion of colloid stability we will explore the reasons why colloidal dispersions can have different degrees of kinetic stability and how these are influenced, and can therefore be modified, by solution and surface properties. Encounters between species in a dispersion can occur frequently due to any of Brownian motion, sedimentation, or stirring. The stability of the dispersion depends upon how the species interact when this happens. The main cause of repulsive forces is the electrostatic repulsion between like charged objects. The main cause of attractive forces is the van der Waals forces between objects.

## 5.1

### Electrostatic and Dispersion Forces

Several repulsive and attractive forces operate between colloidal species and determine their stability [12,13,15,26,152,194]. In the simplest example of colloid stability, dispersed species would be stabilized entirely by the repulsive forces created when two charged surfaces approach each other and their electric double layers overlap. The overlap causes a coulombic repulsive force acting against each surface, which will act in opposition to any attempt to decrease the separation distance (see Figure 5.2). One can express the coulombic repulsive force between plates as a potential energy of repulsion. There is another important repulsive force causing a strong repulsion at very small separation distances where the atomic electron clouds overlap, called Born repulsion.

There also exist dispersion, or London–van der Waals forces that molecules exert towards each other. These forces are usually attractive in nature and result from the orientation of dipoles, and may be dipole–dipole (Keesom dispersion forces), dipole–induced dipole (Debye dispersion forces), or induced dipole–induced dipole



**Figure 5.2** Illustration of the overlap of two double layers when a pair of plates approach to a separation distance,  $H$ .



(London dispersion forces). Except for quite polar materials the London dispersion forces are the more significant of the three. For molecules the force varies inversely with the sixth power of the intermolecular distance. For particles and droplets the force varies approximately inversely with interparticle distance.

### 5.1.1

#### Repulsive Forces

In the simplest example of colloid stability, suspension particles would be stabilized entirely by the repulsive forces created when two charged surfaces approach each other and their electric double layers overlap. The repulsive energy  $V_R$  for spherical particles, or rigid droplets, is given approximately as:

$$V_R = (B\epsilon k^2 T^2 a \gamma^2 / z^2) \exp [-\kappa H] \quad (5.1)$$

where the spheres have radius  $a$  and are separated by distance  $H$ .  $B$  is a constant ( $3.93 \times 10^{39} \text{ A}^{-2} \text{ s}^{-2}$ ),  $z$  is the counter-ion charge number, and  $\gamma$  is given by Eq. (4.6), evaluated using surface potentials  $\psi = \psi^0$ . In order to use these equations with experimental data the question of what value of potential to use in Eq. (5.1) arises. Colloid textbooks frequently specify surface potential in their examples, but this value is seldom experimentally accessible for practical dispersions. A common practical simplification is to take the shear plane to be close to the Stern plane and use the zeta potential, which is accessible to experimental determination, so that we get  $\psi \approx \psi(\delta) = \zeta$  in:

$$\gamma = (\exp [ze \psi(\delta) / 2kT] - 1) / (\exp [ze \psi(\delta) / 2kT] + 1) \quad (5.2)$$

In practice the situation may be more complicated. The shear plane may actually lie about 20 nm further away from the surface than the Stern plane, closer to the Gouy plane [271]. Also, if particle surfaces are covered by long chain molecules (physically or chemically bonded to the surface) then steric repulsion between particles may be significant. This repulsion is due to an osmotic effect caused by the high concentration of chains that are forced to overlap when particles closely approach, and also due to the volume restriction, or entropy decrease, that occurs when the chains lose possible conformations due to overlapping.

In foam stability, gas bubbles and the liquid films between them, would be stabilized by the repulsive forces created when two charged interfaces approach each other and their electric double layers overlap. The repulsive energy  $V_R$  for the double layers at each interface in the thin film is still given by Eq. (5.1); where  $H$  is the film thickness. Here also, for extremely thin films, such as the Newton black films, Born repulsion becomes important as an additional repulsive force.

## 5.1.2

**Dispersion Forces**

Van der Waals postulated that neutral molecules exert forces of attraction on each other which are caused by electrical interactions between dipoles. The attraction results from the orientation of dipoles due to any of (1) Keesom forces between permanent dipoles, (2) Debye induction forces between dipoles and induced dipoles, or (3) London–van der Waals dispersion forces between fluctuating dipoles and induced dipoles. (The term dispersion forces arose because they are largely determined by outer electrons, which are also responsible for the dispersion of light [272].) Except for quite polar materials the London–van der Waals dispersion forces are the more significant of the three. For molecules the force varies inversely with the sixth power of the intermolecular distance.

For dispersed particles (or droplets, etc.) the dispersion forces can be approximated by adding up the attractions between all interparticle pairs of molecules. When added this way the dispersion force between two particles decays less rapidly as a function of separation distance than is the case for individual molecules. For two spheres of radius  $a$  in a vacuum, separated by a small distance  $H$ , the attractive energy  $V_A$  can be approximated by:

$$V_A = -Aa / 12H \quad (5.3)$$

for  $H < 10\text{--}20$  nm and  $H \ll a$ . The constant  $A$  is known as the Hamaker constant and depends on the density and polarizability of atoms in the dispersed species. Typically  $10^{-20}$  J  $< A < 10^{-19}$  J, or  $0.25$  kT  $< A < 25$  kT at room temperature [273]. Materials like polymers have low Hamaker constants ( $\sim 4 \times 10^{-20}$  J) while materials like metals have relatively large Hamaker constants ( $\sim 3 \times 10^{-19}$  J). When the species are in a medium other than vacuum, the attraction is reduced. This can be accounted for by using an effective Hamaker constant:

$$A = (\sqrt{A_2} - \sqrt{A_1})^2 \quad (5.4)$$

where the subscripts denote the medium (1) and the dispersed species (2). The effective Hamaker constant equation shows that the attraction between particles is weakest when the particles and medium are most chemically similar ( $A_1 \approx A_2$ ). Much more exact, and complicated, expressions are available [53]. The Hamaker constants are usually not well known and must be approximated. Some methods for calculating these constants are discussed by Nguyen and Schulze [53].

For a liquid film in a foam, when the attractions between all interdroplet pairs of molecules are added, the dispersion force in a liquid film decays somewhat differently as a function of separation distance:

$$V_A = -V_2/t^2 \quad (5.5)$$

where  $t$  is the film thickness and  $V_2$  is a constant for the particular system and contains the effective Hamaker constant (see Ref. [13]).

## 5.2

## DLVO Theory and Practice

## 5.2.1

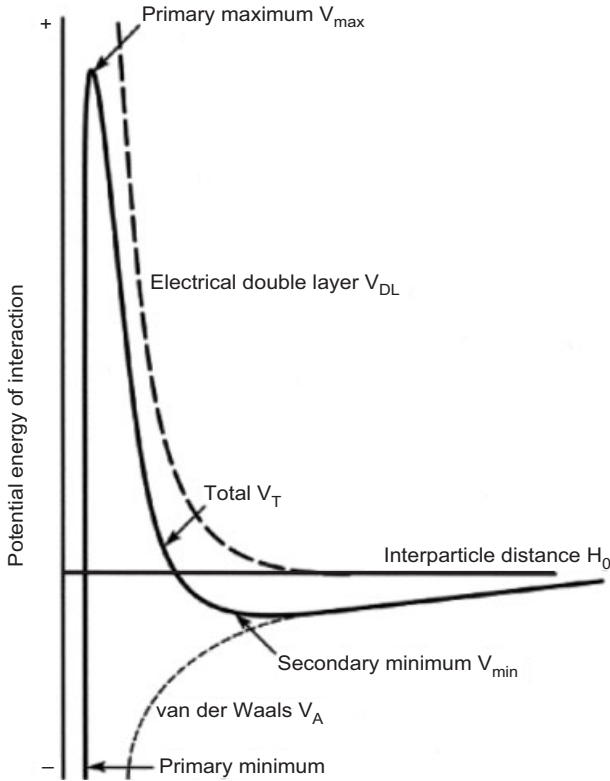
## Theory

Derjaguin and Landau [274,275], and Verwey and Overbeek [276] developed a quantitative theory for the stability of lyophobic colloids, known as DLVO theory. It was known from experiment that classical colloids (e.g., AgI, Au) coagulated quickly at high electrolyte concentrations and slowly at low concentrations with a very narrow electrolyte concentration range over which the transition from kinetically stable to kinetically unstable occurred. Thus a critical coagulation concentration (CCC) could be defined. Using DLVO theory, one can calculate the energy changes that take place when two particles approach each other by estimating the potential energies of attraction (London–van der Waals dispersion,  $V_A$ ) and repulsion (electrostatic including Born,  $V_R$ ) versus interparticle distance. These are then added together to yield the total interaction energy,  $V_T$ .

$$V_T = V_R + V_A \quad (5.6)$$

The theory has been developed for two special cases, the interaction between parallel plates of infinite area and thickness, and the interaction between two spheres. The original calculations of dispersion forces employed a model due to Hamaker although more precise treatments now exist [194].

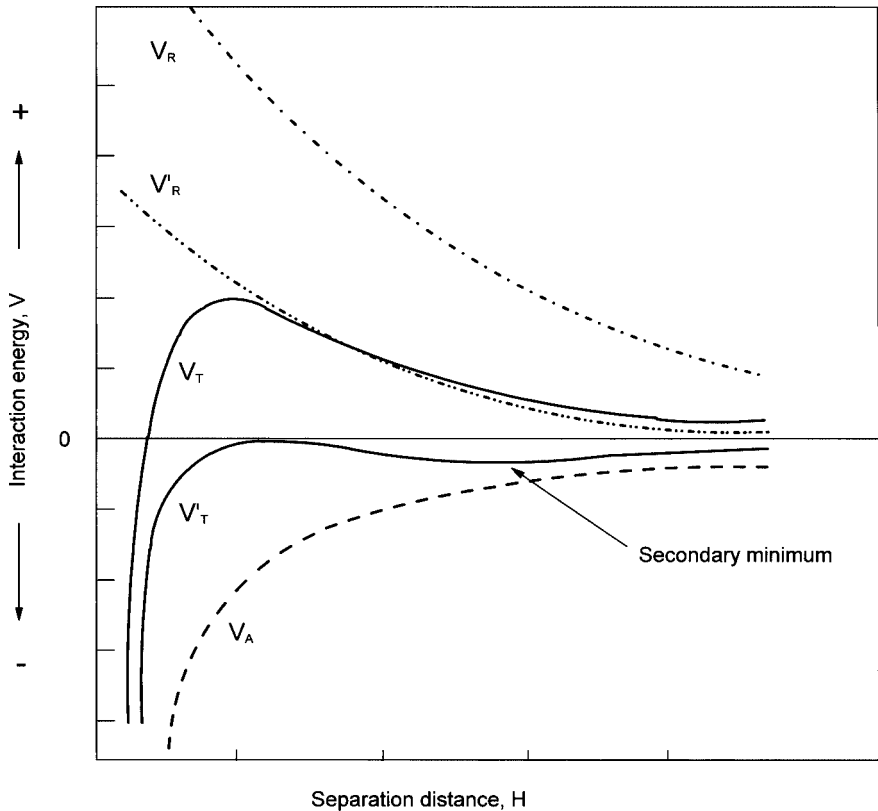
$V_R$  decreases exponentially with separation distance having a range about equal to  $\kappa^{-1}$  while  $V_A$  decreases inversely with separation distance. Figure 5.3 shows how van der Waals forces can predominate at small and large interparticle distances. Repulsive forces can predominate at extremely small (Born) and intermediate (electric double layer) separation distances. If the colloidal species are charged and have an interfacial potential of about 25–50 mV, the DLVO model predicts for binary particle interactions that a substantial repulsive potential energy barrier will inhibit the close approach of the particles, thereby stabilizing them against aggregation ( $V_{\max}$  in Figure 5.3). The primary maximum usually ensures stability, if its magnitude ( $V_{\max}$ ) exceeds the range 10–15 kT; smaller barriers lead to irreversible aggregation in the primary minimum [12,13,16,26,81,274–276,]. The secondary minimum ( $V_{\min}$ ) can promote a loose, easily reversible aggregation of particles, if its magnitude is on the order of 10 kT or more [194]. In clay colloids this is part of the explanation for flocculation as distinguished from coagulation. The overall energy barrier to coagulation in the primary minimum ( $V_{\text{barrier}}$ ) is given by the expression,  $V_{\max} - V_{\min}$ , where the primary minimum represents the potential energy at contact. Stability ensues if the magnitude of  $V_{\text{barrier}}$  exceeds 10–15 kT and is therefore large compared to the thermal energy of the particles. Note that the primary minimum has a finite depth because of the contributions of the Born repulsion and the structure of liquid at the particle surface (not shown) for separations very close to particle contact [194].



**Figure 5.3** Potential energies of interaction between two colloidal particles as a function of their distance of separation, for electrical double layers due to surface charge ( $V_{DL}$ ), London-van der Waals dispersion forces ( $V_A$ ), and the total interaction ( $V_T$ ). From Schramm [426]. Copyright 2003, Wiley.

$V_R$  decreases exponentially with increasing separation distance, and has a range about equal to  $\kappa^{-1}$ , while  $V_A$  decreases inversely with increasing separation distance. Figure 5.4 shows a single attractive energy curve and two different repulsive energy curves, representing two very different levels of electrolyte concentration. The figure shows the total interaction energy curves that result in each case. It can be seen that either the attractive van der Waals forces or the repulsive electric double layer forces can predominate at different interparticle distances.

Where there is a positive potential energy maximum, a dispersion should be stable if  $V \gg kT$ , that is, if the energy is large compared to the thermal energy of the particles ( $15kT$  is considered unsurmountable). In this case colliding particles should rebound without contact and the suspension should be stable to aggregation. If, on the other hand, the potential energy maximum is not very great,  $V \approx kT$ , then slow aggregation should occur. The height of the energy barrier depends on the surface potential,  $\psi(\delta)$  and on the range of the repulsive forces,  $\kappa^{-1}$ . Figure 5.4 shows

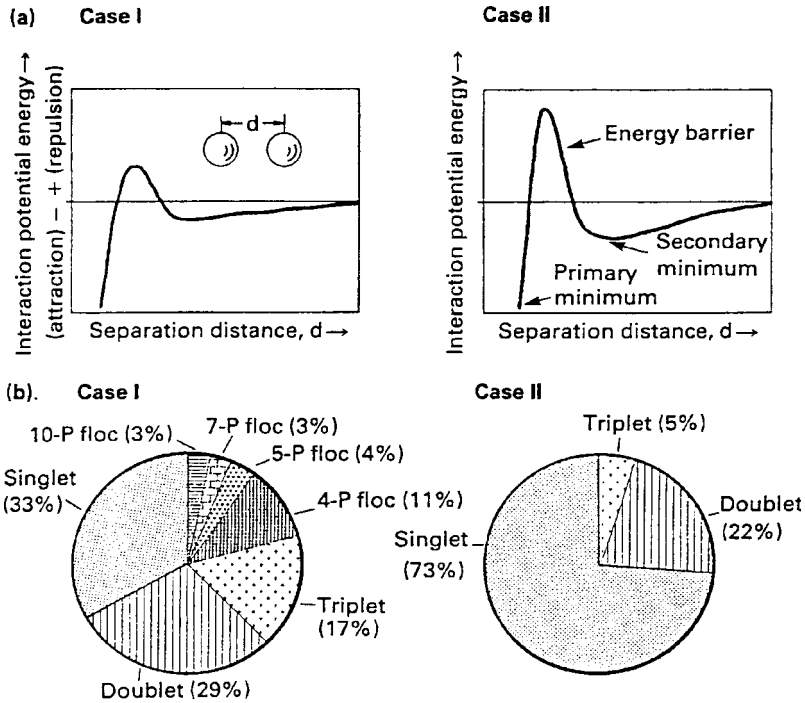


**Figure 5.4** Two interaction energy curves,  $V_T$  and  $V'_T$ , resulting from the summation of an attraction curve ( $V_A$ ) with two different repulsive energy curves,  $V_R$  and  $V'_R$ .

that an energy minimum can occur at larger interparticle distances. If this is reasonably deep compared to  $kT$  then a loose, easily reversible aggregation should occur. In clay colloids this is the explanation for flocculation as distinguished from coagulation.

An illustration of the effects of altering the height of the potential energy maximum is shown in Figure 5.5(a). Here computer simulations were conducted [277] for the interaction between two spherical particles based on DLVO theory. As particles approach each other and pass through the secondary minimum they experience a small (case I) or a larger (case II) energy barrier that has to be surmounted to reach the primary energy well. In this case the energy barrier was adjusted by reducing the concentration of indifferent electrolyte for case II. The effects on the proportions of primary particles versus aggregated particles are shown in Figure 5.5(b).

The same principle applies to emulsion droplets. Isaacs and Chow [130] illustrate the destabilization of a W/O emulsion by reducing the potential energy maximum



**Figure 5.5** Interaction energy curves for two spherical particles in the presence of two different concentrations of indifferent electrolyte (a). The aggregation statistics are shown in (b) for each case, in terms of the percentages of primary particles versus aggregates. From Williams and Jia [277]. Copyright 1992, Society of Chemical Industry.

through the addition of a coagulant. In this case the surface potential was monitored by ultrasonic vibration potential.

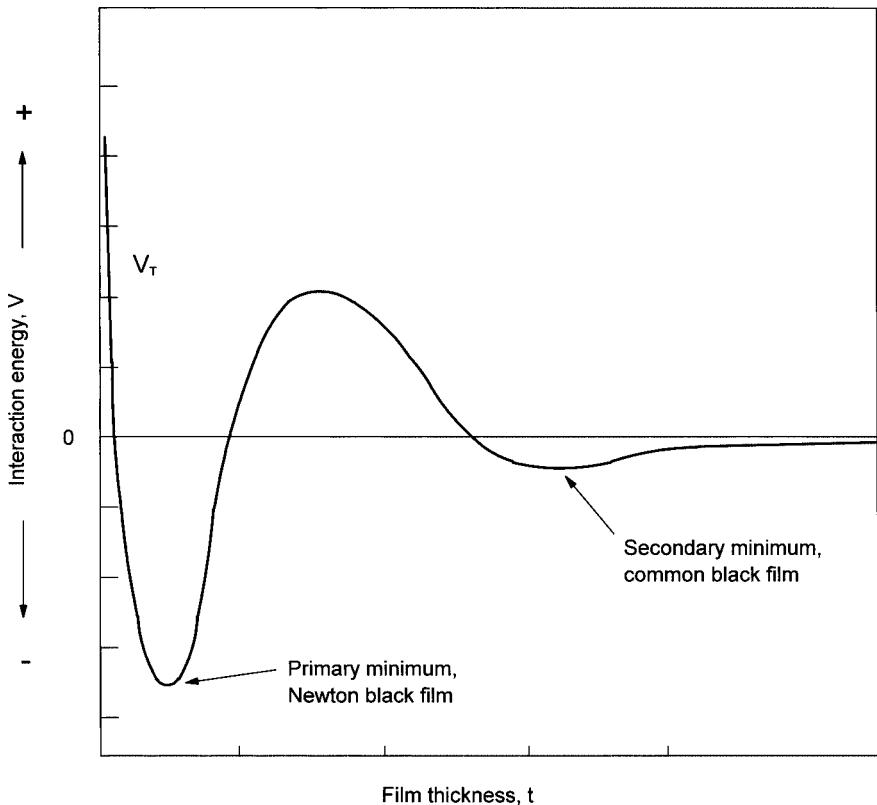
The classic DLVO models are for flat planes and spheres, but more complex shapes arise in practice. For example, there will be some distortion of originally spherical emulsion droplets as they approach each other and begin to seriously interact, causing a flattening. The model has been extended to systems with particles that differ in size, shape, and chemical composition [274], and to those with particles that have an adsorbed layer of ions [12,13,15,16,26,81,274–276]. Volkov *et al.* [278] review the development of other refinements, including situations involving high electric potentials, degrees of approach of adsorbed ions, and non-uniform dielectric permittivity.

In the case of a liquid film separating two bubbles in a foam, and where only the electrical and van der Waals forces are considered,

$$V_T = V_R + V_A = [V_1 \exp(-\kappa t)] - V_2/t^2 \quad (5.7)$$

For foams,  $V_R$  decreases exponentially with increasing separation distance, and has a range about equal to  $\kappa^{-1}$ , while  $V_A$  decreases inversely with the square of increasing separation distance.

Figure 5.6 shows an example of a total interaction energy curve for a thin liquid film stabilized by the presence of ionic surfactant. It can be seen that either the attractive van der Waals forces or the repulsive electric double-layer forces can predominate at different film thicknesses. In the example shown, attractive forces dominate at large film thicknesses. As the thickness decreases the attraction increases but eventually the repulsive forces become significant so that a minimum in the curve may occur, this is called the secondary minimum and may be thought of as a thickness in which a meta-stable state exists, that of the common black film. As the



**Figure 5.6** The total interaction energy,  $V_T$ , between the surfaces of a thin liquid film or foam lamella, as a function of the film thickness,  $t$ .

film thickness decreases further repulsive forces increase but eventually the attractive forces dominate again and a much stronger minimum may occur in the curve. This is referred to as the primary minimum, the film is now in a state of greater stability than before, that of the Newton black film. At smaller film thicknesses repulsive forces dominate once more due to Born repulsion.

The role of electrostatic repulsion in the stability of suspensions of particles in non-aqueous media is not entirely clear. In attempting to apply DLVO theory it can be difficult to judge the electrical potential at the surface, the appropriate Hamaker constant, and the ionic strength to be used for the non-aqueous medium. The ionic strength will be low so the electric double layer will be thick, typically several  $\mu\text{m}$ , the electric potential will vary slowly with separation distance, and so will the net electric potential as the double layers overlap. As a result the repulsion between particles can be expected to be weak [215,279].

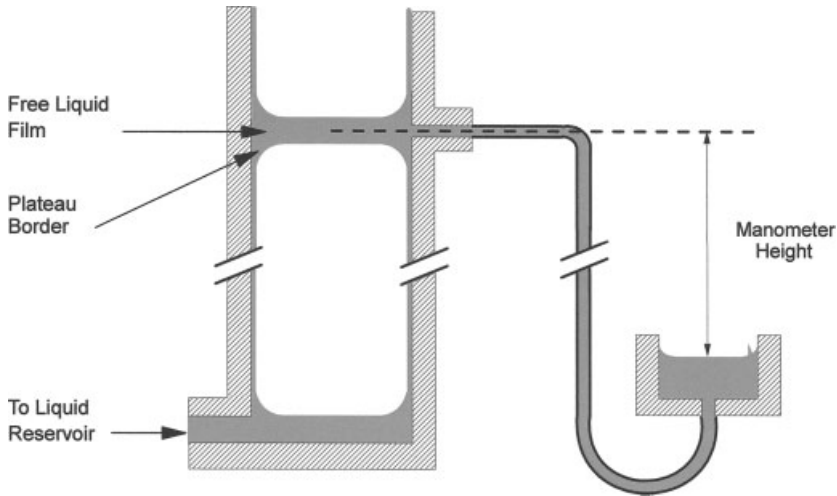
There is an additional application of DLVO theory for emulsions and foams. Here, as droplets or bubbles approach each other, the droplets or bubbles may change (distort) their shape allowing the creation of thin liquid films between the interfaces. When the interfaces bounding a thin film are electrically charged, the interacting diffuse double layers exert a hydrostatic pressure which acts to keep the interfaces apart. In thin films (film thicknesses on the order of a few hundred nm) the electrostatic, dispersion, and steric forces all may be significant and the disjoining pressure concept is frequently employed. The disjoining pressure,  $\pi$ , represents the net pressure difference between the pressure in the thin film and that in the bulk liquid from which the thin film extends [236,274,275,280,281] and is the total of electrical,  $\pi_E$ , dispersion,  $\pi_A$ , steric,  $\pi_S$ , and hydration (solvation) forces,  $\pi_H$ , operating across the thin film (perpendicular to the interfaces). The disjoining pressure may be expressed by taking the derivative of the interaction potential with respect to the film thickness:

$$\pi(h) = -dV/dh = \pi_E + \pi_A + \pi_S + \pi_H \quad (5.8)$$

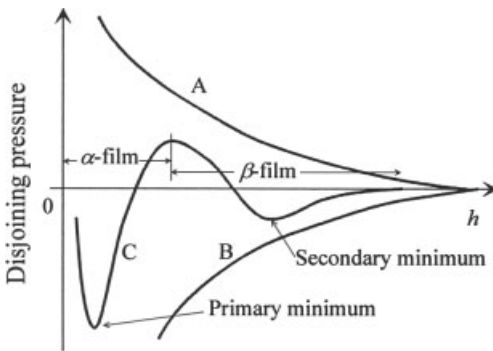
Figure 5.7 illustrates how the disjoining pressure can be determined. A film is formed and liquid is withdrawn from it through a slit in the vertical wall of the apparatus. This produces a free liquid film (a), whose surface is under the same pressure,  $P = P_N$ , as the bulk gas phase. The free liquid film is in mechanical equilibrium with the adjacent Plateau borders, or wetting menisci. The Plateau borders at (b), away from the transition zone (c), contain liquid under pressure  $P_0$ . The disjoining pressure is then given as  $\pi(h) = P_N - P_0$ , where  $h$  is the film thickness. Measurements of  $\pi$  as a function of  $h$  may be performed using thin-film balances of this type [194,274,275,280]. To the extent that the disjoining pressure arises from electrostatic forces, there will be an obvious influence of electrolyte concentration. For very thin films ( $< 1000 \text{ \AA}$ ) the disjoining pressure is very important. But for thicker films and wetter foams, the factors discussed previously are more important.

Figure 5.8 shows a hypothetical  $\pi(h)$  isotherm for a foam film, illustrating the primary and secondary minima. A slightly more complicated isotherm is shown in Figure 5.15.





**Figure 5.7** Illustration of a disjoining pressure apparatus.



**Figure 5.8** Hypothetical disjoining pressure isotherm for a foam film illustrating the primary and secondary minima. From Nguyen and Schulze [53]. Copyright 2004, Dekker.

Correa and Saramago [282] describe the calculation of disjoining pressures for non-aqueous films. In this case the dispersion forces were found to be the most important in determining thin-film stability.

### 5.2.2

#### Practical Guidelines

It will be apparent that the DLVO calculations can become quite involved, requiring considerable knowledge about the systems of interest. Also, there are some problems. For example, there will be some distortion of the spherical emulsion droplets as they approach each other and begin to seriously interact, causing a flattening.

Also, the prevailing assessment of the validity of the theory is changing as more becomes known about the influence of additional forces, such as those due to surface hydration. In addition, there is now considerable effort being devoted to directly determining the forces between colloidal particles, which until recently could only be inferred. For reviews on this topic and the use of the surface force apparatus see Refs. [194,283,284]. The DLVO theory nevertheless forms a very useful starting point in attempting to understand complex colloidal systems such as industrial emulsions, foams, and suspensions. There are empirical “rules of thumb” that can be used to give a first estimate of the degree of colloidal stability that a system is likely to have if the zeta potentials of the droplets, bubbles, or particles are known.

Many types of colloids tend to adopt a negative surface charge when dispersed in aqueous solutions, having ionic concentrations and pH typical of natural waters. For such systems one rule of thumb stems from observations that the colloidal particles are quite stable when the zeta potential is about  $-30$  mV or more negative, and quite unstable due to agglomeration when the zeta potential is between  $+5$  and  $-5$  mV. An expanded set of guidelines, developed for particle suspensions, is given in Table 5.1 (from Ref. [259]). Such criteria are frequently used to determine optimal dosages of polyvalent metal electrolytes, such as alum, used to effect coagulation in treatment plants.

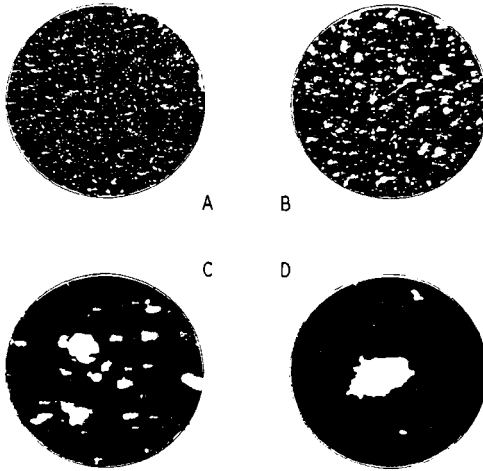
**Table 5.1** Stability criteria based on zeta potential\*.

Stability characteristics	Zeta potential (mV)
Maximum agglomeration and precipitation	+3 to zero
Excellent agglomeration and precipitation	-1 to -4
Fair agglomeration and precipitation	-5 to -10
Agglomeration threshold (agglomerates of 2–10 particles)	-11 to -20
Plateau of slight stability (few agglomerates)	-21 to -30
Moderate stability (no agglomerates)	-31 to -40
Good stability	-41 to -50
Very good stability	-51 to -60
Excellent stability	-61 to -80
Maximum stability – for solids	-81 to -100
– for emulsions	-81 to -125

\* From [259].

An illustration is shown in Figure 5.9, where  $1.1\ \mu\text{m}$  size silica particles are progressively coagulated by increasing additions of alum (0, 10, 30, 40 ppm, in each case with some sodium bicarbonate and activated silica).

There are many other applications of zeta potential, some of which are discussed in later sections, including mineral flotation (Section 10.3.1), bitumen flotation (Section 11.3.2), paper-making (Section 12.2), and many others.



**Figure 5.9** Illustration of the effect of electrolyte on colloid stability. The photomicrographs A through D show how 1.1  $\mu\text{m}$  size silica particles are progressively coagulated by increasing additions of alum (0, 10, 30, 40 ppm, respectively). The corresponding zeta potentials are  $-30$  mV (A),  $-14$  mV (B),  $-6$  mV (C), and  $-0$  mV (D). From Zeta-Meter [544]. Courtesy L.A. Ravina, Zeta-Meter, Inc., Staunton, Va.

### 5.2.3

#### Schulze–Hardy Rule

The transition from stable dispersion to aggregation usually occurs over a fairly small range of electrolyte concentration. This makes it possible to determine aggregation concentrations, often referred to as critical coagulation concentrations (CCC). The Schulze–Hardy rule summarizes the general tendency of the CCC to vary inversely with the sixth power of the counter-ion charge number (for indifferent electrolyte).

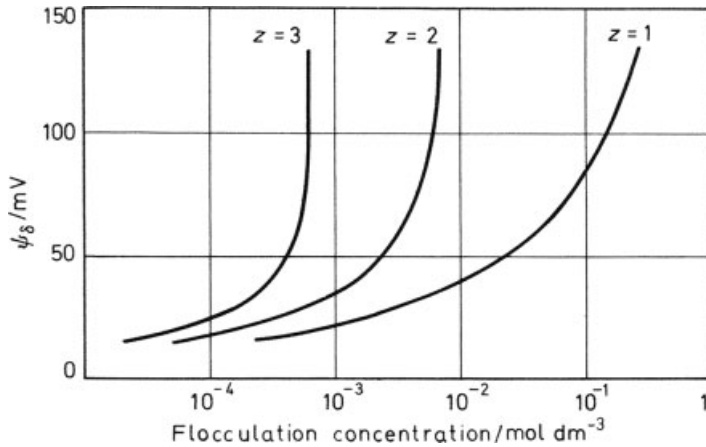
A prediction from DLVO theory can be made by deriving the conditions under which  $V = 0$  and  $dV/dH = 0$ . The result is

$$\text{CCC} = (9.75 B^2 \varepsilon^3 k^5 T^5 \gamma^4) / (e^2 N_A A^2 z^6) \quad (5.9)$$

For aqueous solutions at ambient temperature,

$$\text{CCC (M)} = (87.4 \times 10^{-40}) / (A^2 z^6) \quad (5.10)$$

It is evident that for high potentials ( $\gamma \rightarrow 1$ ) the CCC varies inversely with  $z^6$ . Experimental results generally give the same relation with  $z$  and calculate back to reasonable values for  $A$ . (For lower potentials this also will influence CCC, but for a



**Figure 5.10** Illustration of critical coagulation concentrations for a range of surface (Stern layer) potentials and indifferent electrolyte counterion charge numbers of 1 through 3. The curves were calculated taking  $A = 10^{-19}$  J,  $\epsilon/\epsilon_0 = 78.5$  and  $T = 298$  K. The sol is predicted to be stable above and to the left of each curve and flocculated below and to the right. From Shaw [60]. Copyright 1966, Butterworths.

given potential, CCC is independent of particle size.) Figure 5.10 gives an example of CCCs for a range of surface (Stern layer) potentials and indifferent electrolyte counter-ion charge numbers of 1 through 3.

**Example.** For clay particles in water, assuming that they to act like flat plates,  $A = 5 \times 10^{-20}$  J,  $C$  in mol/L, and area  $2500 \text{ nm}^2$ ,  $[e\psi(\delta)]/kT = 4$  (i.e.,  $\psi(\delta) \approx 100$  mV) gives the critical coagulation concentrations in polyvalent metal chlorides as follows:

Dissolved salt	$z$	CCC mol/L
NaCl	1	1.18
CaCl <sub>2</sub>	2	0.018
AlCl <sub>3</sub>	3	0.0016

The transitions from stable dispersion to aggregation just described in terms of the critical coagulation concentrations and the Schulze–Hardy rule, apply best to suspensions in which the particles have only one kind of charge. However, clay particles can carry positive and negative charges at the same time, on different parts of the particle. See Section 5.6.2.

Finally, the Schulze–Hardy provides a very useful rule of thumb, but it is limited in that it only addresses first-order effects. Secondary effects that will have a bearing on aggregation and CCCs include specific adsorption of ions in the Stern layer,

which is enhanced by larger polarizability and lower hydration (i.e., larger ion size). The strength of the adsorption varies, according to the lyotropic (Hofmeister) series, for example,  $\text{Cs}^+ > \text{Rb}^+ > \text{K}^+ > \text{Na}^+ > \text{Li}^+$  (decreasing order of aggregating power for negatively charged dispersions). For positively charged dispersions, the decreasing order of aggregating power of anions is  $\text{F}^- > \text{Cl}^- > \text{Br}^- > \text{NO}_3^- > \text{I}^- > \text{CNS}^-$ . Stern layer theory can be applied to DLVO theory but it adds additional parameters that are difficult to evaluate. Although this is a significant issue from a theoretical point of view, it is less of a problem in practical applications when experimentally determined electrokinetic data are used to calculate  $\psi$  or  $\gamma$  because in such cases one assumes  $\zeta \approx \psi(\delta)$ .

#### 5.2.4

##### **Peptization**

The same principles as discussed above can be applied to creating a transition from an aggregated dispersion to a well-dispersed system, again by adjusting electrolyte composition and concentration. Simply diluting-out the coagulating electrolyte will permit re-dispersion (peptization) once the concentration falls below the CCC. This can be accomplished by repeatedly diluting, centrifuging, and decanting, or by combining repeated or continuous dilution using such techniques as dialysis and ultrafiltration [267,285].

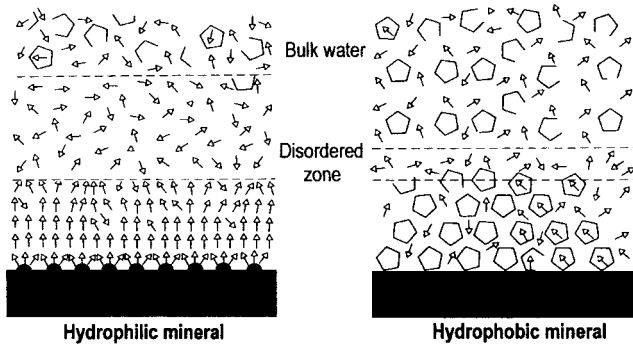
Peptization also occurs naturally, such as when flowing water acts to convert unconsolidated particulate rock material into colloidal suspensions [49]. In this case peptization can be due to both the dilution effect and also to ion exchange reactions (such as the exchange of coagulating calcium ions for peptizing sodium ions).

#### 5.3

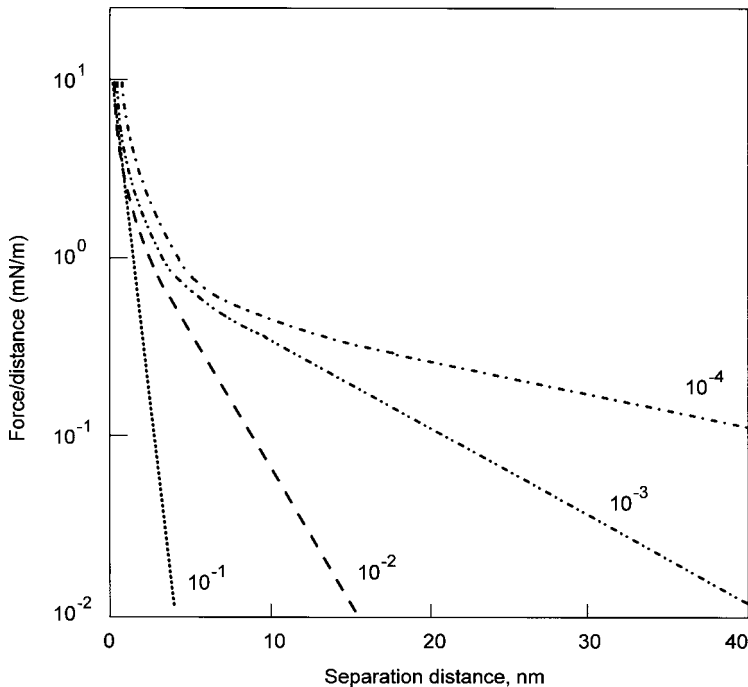
##### **Hydration and Steric Effects**

Additional influences on dispersion stability beyond those accounted for by the DLVO theory, like surface hydration and steric effects, have received considerable attention over the past several decades [194,278].

Beyond the DLVO forces there is an additional short-range “structural” repulsive force due to perturbation of the molecular ordering at hydrated surfaces. This arises when surfaces contain water molecules adsorbed by hydrogen bonding, such as when water molecules are bound to the surface silanol groups of silica. Figure 5.11 illustrates some possible water structures near hydrophilic and hydrophobic surfaces. Overlapping of the perturbed water molecules can lead to forces that are either attractive (hydrophobic forces) or repulsive (hydration forces) in nature [194,280]. The hydration repulsive force operates at separation distances of the order of 2–3 nm as shown in Figure 5.12 [284]. For negatively charged surfaces the repulsive hydration force can be accentuated at high ionic strengths due to the adsorption of hydrated metal cations.



**Figure 5.11** Illustrations of possible water structure at hydrophilic and hydrophobic surfaces. Bulk water is shown by pentagonal and partial pentagonal circuits, which indicate structural entities being in equilibrium with monomeric water represented by arrows. Dipole-dipole interaction at a hydrophilic surface causes ordering of water molecules, leading to a notable disordered zone. Water molecules at a hydrophobic surface have extensive clathrate-like structure with a minimal disordered zone. From Nguyen and Schulze [53]. Copyright 2004, Dekker.

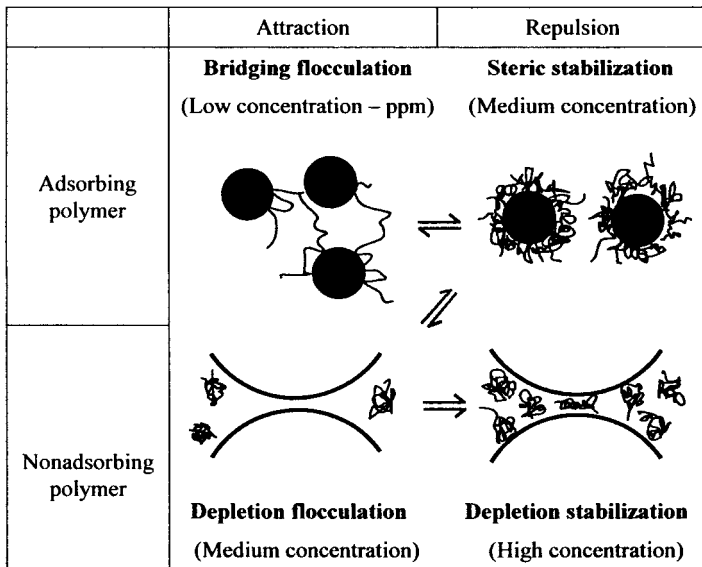


**Figure 5.12** Illustration of force curves between silica surfaces in aqueous solutions of sodium chloride at various molar concentrations. At short range there is a strong repulsion which is not accounted for in the standard DLVO theory, due to hydration forces. Drawn based on data in Horn [284].

The stability of a dispersion can also be enhanced (protection, by steric stabilization) or reduced (sensitization, by bridging flocculation) by the addition of material that adsorbs onto particle surfaces. Figure 5.13 provides an illustration. Protective agents can act in several ways:

- they can increase double layer repulsion if they have ionizable groups;
- the adsorbed layers can lower the effective Hamaker constant;
- an adsorbed film may necessitate desorption before particles can approach closely enough for van der Waals forces to cause attraction; or
- approaching particles may simply cause adsorbed molecules to become restricted in their freedom of motion (volume restriction).

The use of natural and synthetic polymers to stabilize aqueous colloidal dispersions is technologically important, with much research in this area being focused on adsorption and steric stabilization [286–291]. Steric stabilization is discussed further in the next section.



**Figure 5.13** Illustrations of bridging flocculation (left) and steric stabilization (right) due to adsorbed polymer molecules, and depletion flocculation and depletion stabilization due to nonadsorbed polymer molecules. From Nguyen and Schulze [53]. Copyright 2004, Dekker.

## 5.3.1

**Steric Stabilization**

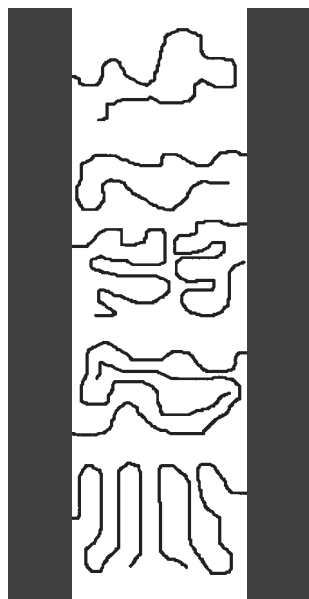
In principle, steric stabilization can result from any of the following [194,280]:

- undulations of the interface(s)
- peristaltic fluctuations as two interfaces approach each other,
- overlap of the head-groups of adsorbed surfactants at the interface(s), and/or
- molecular-scale protrusions of surfactant or polymer chains.

Of these, the last is probably the most common.

At high polymer-dispersed species ratios, long-chain surfactants and high molecular-weight polymers can become adsorbed at the surfaces of dispersed species such that a significant amount of adsorbate extends out from the surfaces. If the adsorbed material extends out significantly from the particle surface, then an entropy decrease can accompany particle approach providing a short-range, volume-restriction, stabilization mechanism referred to as steric stabilization (Figure 5.14 [291]). The most important factor influencing the degree of steric stabilization is the thickness of the adsorbed layer in comparison with the size of the particles [292]. The term protection has also been used because the steric stabilizing effect can cause significant salt tolerance on the part of a colloidal dispersion. Some suspensions have been prepared, using high concentrations of polyelectrolytes, that are quite stable in concentrated salt solutions [49].

In almost all cases there will be adsorption layers on each approaching droplet, bubble, or particle surface so there will also be an osmotic pressure contribution, again at close approach, due to overlap of the adsorption layers. The osmotic contri-



**Figure 5.14** Illustration of volume-restriction steric repulsion by adsorbed polymer molecules.

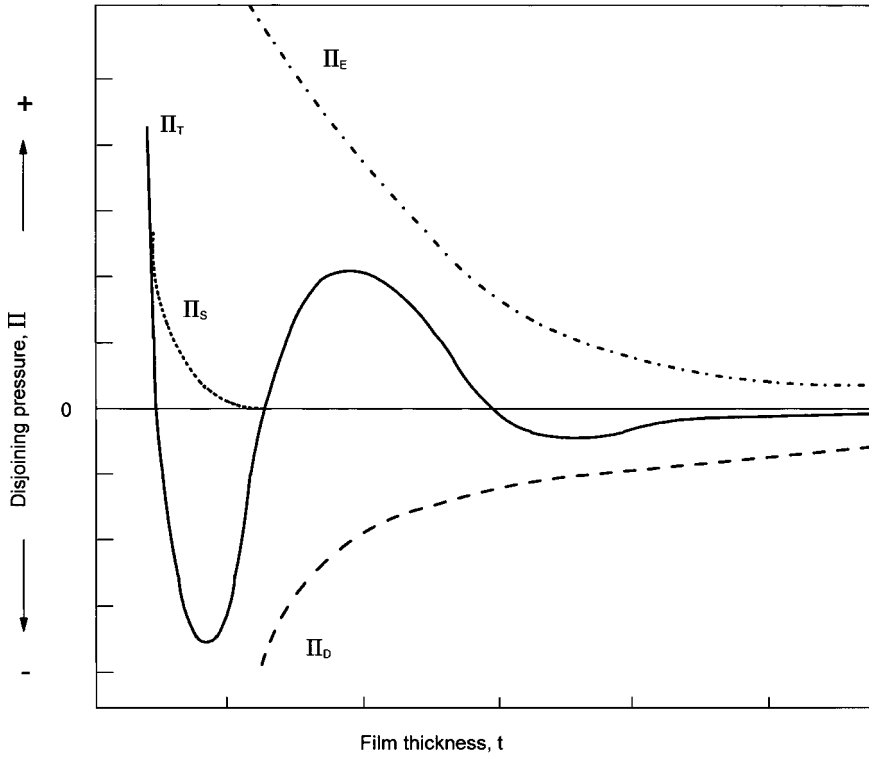


bution may result in increased repulsion, or not, depending on the favourability of the mixing of the protruding chains of the adsorbed species. Damodaran [293] provides an equation for the net steric repulsive energy potential between protein-stabilized emulsion droplets, which illustrates the relative contributions of an osmotic repulsive contribution that favours stretching the chains, and elastic energy of the chains that opposes the stretching.

In steric stabilization, adsorbed polymer molecules must extend outward from the particle surface, yet be strongly enough attached to the surface that it remains adsorbed in the presence of applied shear. An example is a system of particles containing terminally anchored block co-polymer chains having a hydrophobic portion of the molecule that is very strongly adsorbed on the particles' surfaces and a hydrophilic part of the molecule that extends outwards from the particle surfaces [53]. The size of the adsorbed molecule determines the extent of the long-range repulsive force between particles and also causes the primary minimum to disappear. It is often difficult to calculate the interaction energy in steric stabilization cases, but it may be possible to estimate the distance over which the polymer molecules extend from the surfaces. This can be used to estimate whether steric stabilization is likely. By changing the nature of the medium such a suspension can be adjusted back and forth between the stable and flocculated conditions. It is also possible to have particles stabilized by both electrostatic and steric stabilization; these are said to be electrosterically stabilized. Many food colloids are electrosterically stabilized (see Chapter 13).

Figure 5.15 shows an example of a disjoining pressure isotherm in which the steric force contributions have been superimposed on the classical DLVO force contributions. It can be seen that this creates two regions for meta-stable foam films. One region is the thick, common black film region, with film thicknesses of approximately 50 nm or so. The other region is the thin, Newton black film region, with film thicknesses of approximately 4 nm. While the common black films are mostly stabilized by electrostatic forces, the Newton black films are at least partly stabilized by the steric forces.

For effective stabilization the particle or droplet surfaces should be fully covered by the adsorbed surfactant or polymer, otherwise uncovered regions of adjacent particles or droplets may come into contact with each other, or bridging flocculation between them may occur. Further, the stabilizing surfactant or polymer should be strongly adsorbed (firmly anchored) to the surfaces. Molecular structure and solvation, adsorption layer thickness and hydrodynamic volume, and temperature also determine the effectiveness of steric stabilization [286–290]. One way to predict whether steric stabilization is likely for a given dispersion is to estimate the protrusion distance of the surfactant or polymer chains [291]. The stabilization of finely divided gold suspensions (gold sols) has been used to provide a basis for comparing the stabilizing, or “protecting” ability of polyelectrolytes. In this test [1] the “gold number” is defined as the number of milligrams of polyelectrolyte that just prevent the flocculation of 10 ml of a gold sol by 1 ml of a 10% solution of sodium chloride. The smaller the gold number the greater the protecting power of the polyelectrolyte.



**Figure 5.15** Illustration of a disjoining pressure isotherm ( $\Pi_T$ ) that includes contributions from electrostatic ( $\Pi_E$ ), dispersion ( $\Pi_D$ ), and steric ( $\Pi_S$ ) forces.

## 5.4 Additional Stabilizing Influences

### 5.4.1 Other Stabilizing Influences for Suspensions Stability

The use of organic compounds to stabilize non-aqueous colloidal dispersions is also technologically important. For example, mineral solids, including clays, can be dispersed in oils when polar organic compounds such as quaternary ammonium surfactants are adsorbed onto their surfaces, making the latter preferentially oil wetting (see Sections 3.4 and 3.5.3). This method can be used to make lubricating greases and oil-based drilling fluids.

The role of turbulence in assisting with suspension stability is described in Section 10.3.1. For example, a rule of thumb for the role of turbulence in maintaining sufficient suspension stability for mineral flotation is the “one-second criterion” which states that the particles in a suspension are sufficiently well dispersed for flo-

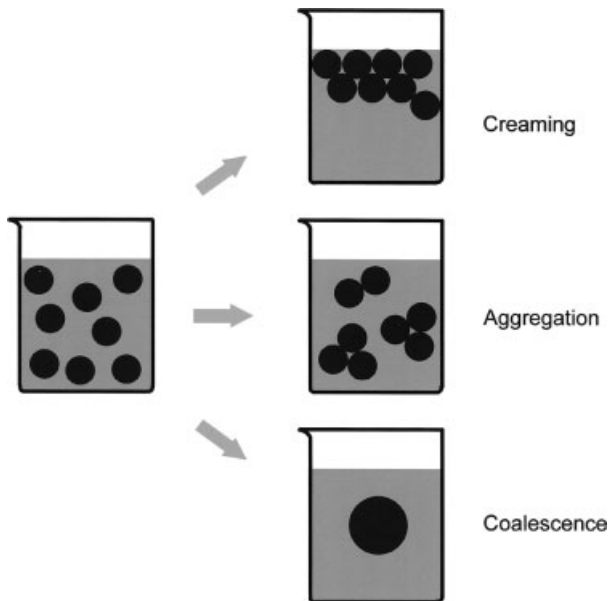
tation if individual particles do not remain settled at the bottom of the flotation vessel for longer than one second.

#### 5.4.2

#### Other Influences on Emulsion Stability

Sedimentation and/or creaming will tend to concentrate dispersed species and tend to promote aggregation. Up to this point, stability to aggregation has been considered. However, once aggregation has taken place in an emulsion there remains the question of stability to coalescence (Figure 5.16). Usually emulsions made by mixing together two pure liquids are not very stable. To increase the stability, an additional component is usually needed, which forms a film around the dispersed droplets providing a barrier to both aggregation and coalescence. Although there are numerous effective agents and mechanisms, the additional component is frequently a surfactant. Stability to coalescence involves the mechanical properties of the interfacial films. Considering stability to both aggregation and droplet coalescence, the factors favouring emulsion stability can be summarized as:

- Low interfacial tension – low interfacial free energy makes it easier to maintain large interfacial area.
- High surface viscosity and/or mechanically strong interfacial film – this acts as a barrier to coalescence and may be enhanced by adsorption of fine solids, or of close-packed surfactant molecules.



**Figure 5.16** Illustration of creaming, aggregation, and coalescence in an emulsion, foam or suspension.

- Large electric double layer and/or steric repulsions – these repulsions act to prevent collisions and aggregation, and therefore coalescence.
- Small dispersion force attraction – this decreases the rate of aggregation and coalescence.
- Small volume of dispersed phase – this reduces the frequency of collisions and aggregation. Higher volumes are possible, for close-packed spheres the dispersed phase volume fraction would be 0.74, but in practice the fraction can be even higher.
- Small droplet size, if the droplets are electrostatically or sterically interacting.
- Small density difference between the phases – this reduces the rate of creaming/sedimenting and therefore collisions and aggregation.
- High bulk viscosity – this reduces the rates of creaming and coalescence.

An assessment of emulsion stability involves the determination of the time variation of some emulsion property such as those described in the physical characteristics section above. The classical methods are well described in Ref. [9]. Some newer approaches include the use of pulsed nuclear magnetic resonance or differential scanning calorimetry [294].

Two additional stabilizing influences will be summarized next: that of viscoelastic films and that of solid-particle films. In general, where electrical surface charge is an important determinant of stability, it is easier to formulate a very stable O/W emulsion than a W/O emulsion because the electric double layer thickness is much greater in water than in oil. (This is sometimes incorrectly stated in terms of greater charge being present on droplets in an O/W emulsion.) However, there are ways to effectively stabilize W/O emulsions.

First, the adsorbed material may form such a rigid film that it poses a mechanical barrier to droplet coalescence. For example, oilfield W/O emulsions may be stabilized by the presence of a viscoelastic, possibly rigid, protective film around the water droplets. Such a film can be formed from the asphaltene and resin fractions of the crude oil. When drops approach each other during the process of aggregation, the rate of oil film drainage will be determined initially by the bulk oil viscosity, but within a certain distance of approach the interfacial viscosity becomes important. A high interfacial viscosity will significantly retard the final stage of film drainage and promote kinetic emulsion stability. If the films are viscoelastic, then a mechanical barrier to coalescence will be provided, yielding a high degree of emulsion stability. In the MRI image shown in Figure 5.1 the angular droplet shapes suggest the presence of viscoelastic interfacial films surrounding these droplets. More detailed descriptions are given in references [295,296].

Secondly, W/O emulsion stability can be caused or promoted through the adsorption of bi-wetting and mutually interacting solids at the oil/water interface. Such Pickering (solids-stabilized) emulsions can exhibit quite mechanically strong films around the dispersed droplets, providing a strong barrier to both aggregation and coalescence.

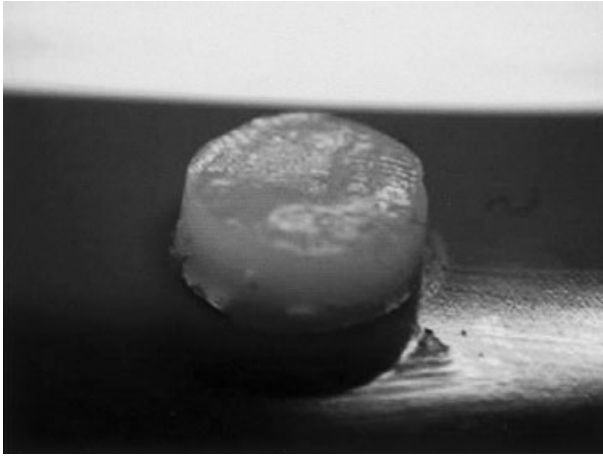
The most stable Pickering emulsions occur when the contact angle is close to 90°, so that the particles will collect at the interface. Combining Young's equation with

the oriented wedge theory (see Section 7.1.1) allows some predictions to be made. The oriented wedge theory states that, if an emulsifying agent is preferentially wetted by one of the phases then more of the agent can be accommodated at the interface if that interface is convex towards that phase – i.e., if that phase is the continuous phase. Thus, if there is a low contact angle ( $\theta < 90^\circ$ , relatively hydrophilic particles), then an oil-in-water (O/W) emulsion should form and a high contact angle ( $\theta > 90^\circ$ , relatively hydrophobic particles) should produce a water-in-oil (W/O) emulsion. For example,

- particles that have been used to stabilize O/W emulsions include silica, clays like kaolinite and montmorillonite, barium sulfate, and the hydrous oxides of vanadium, iron (III), and aluminum;
- particles that have been used to stabilize W/O emulsions which include carbon black, asphaltenes, and waxes.

In food science, ice crystals play a role in stabilizing ice cream, while fat crystals play a role in stabilizing whipping cream. It should be emphasized that in practice the contact angles should neither be too high nor too low, or else the particles will remain in the water or oil phases, respectively, and not stabilize an emulsion [297]. Although there are many exceptions to such rules they remain useful for making initial predictions. The particles used for emulsion stabilization have to be much smaller than the size of the emulsion droplets they are intended to stabilize so the particles are usually quite small, typically less than 1  $\mu\text{m}$  in diameter.

As already mentioned, in Pickering emulsions the particles can be quite close-packed and the stabilizing film between droplets can be quite rigid, providing a strong mechanical barrier to coalescence. If charged, then electrostatic repulsion will also contribute to emulsion stability. This can lead to emulsions having stabilities on the order of 1 year [298]. For this to occur the solid particles need to be well anchored at the oil/water interface and to have significant lateral attractive interactions with each other [298]. Hydrophilic silica particles that have been partially hydrophobized by treatment with organosilane compounds are bi-wetting and can exhibit significant lateral (mutual) attraction when adsorbed at the O/W interface. Figure 5.17 shows an example of a Pickering O/W emulsion having such mechanically strong interfacial films that the emulsion could be dried to a semi-solid state without significant oil droplet coalescence. Arditty *et al.* [298,299] and Binks [297] describe the preparation of O/W, W/O and multiple emulsions using solid particles as the stabilizing agents. Noble *et al.* [300] describe the preparation of colloidosome emulsions, stabilized by networks of microrods (microfibres).



**Figure 5.17** A Pickering O/W emulsion that had sufficient stability to permit partial drying at 40 °C to this semi-solid disc shape. From Arditty [298]. Copyright 2004, Elsevier.

### 5.4.3

#### Other Influences on Foam Stability

Where there exists a bubble size distribution there will exist pressure gradients between bubbles of different size in a foam. Concentration gradients may form across lamellae which promotes gas diffusion between bubbles. This effect will cause larger bubbles to grow at the expense of smaller bubbles, and is termed disproportionation. It becomes a mechanism for foam degeneration as the liquid films thin between the bubbles. Foam stability involves stability against two different processes: film thinning and coalescence (film rupture). In film thinning, two or more bubbles approach closely together – the liquid films separating them thin – but the bubbles do not actually touch each other and there is no change in total surface area. In coalescence the thin liquid film between bubbles ruptures and the bubbles fuse together to form a single larger bubble.

Foam drainage, driven by capillary pressure (that is, suction from plateau borders), is thus an important element in the formation and early development of a foam, as reviewed by Weaire *et al.* [109] and Wasan *et al.* [301]. Although the drainage half-life of a typical foam is of the order of tens of minutes, some foams can have much greater stability. In carefully controlled environments, it has been possible to make surfactant-stabilized foam bubbles and films having lifetimes of from months to years [45]. Prins [302] reviews foam-making and stabilizing. Pugh [281] reviews both foaming and defoaming phenomena.

Foaming capability relates to both foam formation and foam persistence. Surface tension lowering is necessary, but not sufficient. Other important factors include surface elasticity, surface viscosity, and disjoining pressure [303]. Considering stabil-

ity to aggregation, film thinning, and bubble coalescence, the factors favouring foam stability can be summarized as follows.

- Low surface tension – makes it easier to form and maintain large interfacial area.
- Low gravity drainage – decreases the rate of film thinning.
- Low capillary suction – decreases the rate of film thinning.
- High surface elasticity – counteracts the effect of surface perturbations.
- High bulk viscosity – reduces the rate of film thinning.
- High surface viscosity – reduces the rate of film rupture.
- High electric double layer repulsion – increases disjoining pressure and reduces the rates of film thinning and rupture.
- High steric repulsion – reduces the rates of film thinning and rupture.
- Low dispersion force attraction – decreases the rates of film thinning and rupture.

Some mildly surface-active compounds will stabilize weakly stable, transient foams. Examples include short-chain alcohols, short chain fatty acids, aniline, phenol, and pine oil. These “weak” frothers tend to produce foam films having stabilities on the order of seconds. More strongly surface-active compounds can stabilize quite strong, meta-stable foams. Examples include long-chain alcohols and fatty acids, and proteins. These “strong” frothers tend to produce foam films having stabilities on the order of minutes to hours.

Solid particles are usually associated with foam destruction, but there are examples of foams being stabilized by fine particles. Hydrophilic particles can enhance aqueous foam stability by collecting in the plateau borders of the foam and retarding film drainage, but it appears that such particles need to have just the right wettability to stabilize a given system. Solid particles together with other, linking, agents can also be involved in foam stabilization, such as is the case with ice cream (see Section 13.5.1). Binks provides other examples [297].

The stability of foams in constraining media, such as porous media, is much more complicated. Some combination of surface elasticity, surface viscosity and disjoining pressure is still needed, but the specific requirements for an effective foam in porous media remain elusive, partly because little relevant information is available and partly because what information there is appears to be somewhat conflicting. For example, both direct [304] and inverse [305] correlations have been found between surface elasticity and foam stability and performance in porous media. Overall, it is generally found that the effectiveness of foams in porous media is not reliably predicted based on bulk physical properties or on bulk foam measurements. Instead, it tends to be more useful to study the foaming properties in porous media at various laboratory scales: micro-, meso-, and macro-scale.

Micro-scale experiments involve the microscopic observation of flowing foams in etched-glass micromodels. Here the pore dimensions are typically on the order of hundreds of micrometers. Such experiments provide valuable and rapidly obtainable qualitative information about foam behaviour in constrained media under a variety of experimental conditions, including the presence of a residual oil saturation

[114,306,307]. Meso-scale experiments involve conducting foam floods in samples of porous rock, which may be reservoir core samples or quarried sandstones and carbonates, the quarried samples being more reproducible. The overall rock dimension here is of the order of 10 cm. These meso-scale foam floods allow the determination of gas mobility reduction by foams under widely varying conditions [1]. The mobility reduction factor (MRF) is the ratio of pressure drops across a core resulting from the simultaneous flow of gas and liquid in the presence and absence of surfactant in the liquid phase. Mobility reduction factors achieved depend on many factors [306,308–310] including all of the chemical compositions, the nature of the porous medium, the foam quality, texture, and flow rate, and the overall temperature and pressure. Macro-scale experiments involve a special apparatus that allows foam floods to be performed at reservoir conditions of temperature and pressure in an integral two-metre length of rock sample, that is, in porous media samples one order of magnitude longer than the meso-scale. In addition to being a first step in scale-up, this allows the study of dynamic foam behaviour that would be impossible in short core samples [311].

## 5.5 Kinetics

From a practical point of view, in addition to understanding the direction in which reactions will proceed, it is just as important to know the rates at which such reactions will proceed. It is the same in colloid science and its applications. For the many lyophobic dispersions that are not thermodynamically stable, the degree of kinetic stability is very important. Although all of the typical rate processes are important, sedimentation (creaming), aggregation, and coalescence, this section will discuss the rate of aggregation.

As introduced earlier, aggregation is when any of Brownian motion, sedimentation, or stirring causes two or more dispersed species to clump together, possibly touching at some points, and with virtually no change in total surface area. Once aggregated the species retain their identity but lose their kinetic independence since the aggregates move as single units. Two principal factors determine the rate of aggregation of particles in a suspension: the frequency of particle encounters, and the probability that the thermal energy of the particles is sufficient to overcome the potential energy barrier to aggregation.

If velocity or shear gradients are present and are sufficiently large, the frequency of collisions depends on the volume fraction of solids and the mean velocity gradient. Assuming that sedimentation is slow compared to other collision mechanisms, the overall aggregation rate,  $-dN/dt$ , is:

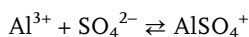
$$-dN/dt = k_d N^2 + k_s N \quad (5.11)$$

where  $N$  is the number concentration of dispersed species,  $k_d$  and  $k_s$  are the respective rate constants corresponding to diffusion-controlled and shear-induced collision



processes, and the minus sign denotes that the number concentration decreases with time,  $t$ . Equation (5.11) can be determined by measuring  $N$  as a function of time (by, for example, light scattering) and then evaluating the rate constants. The constants,  $k_d$  and  $k_s$ , depend on particle/droplet/bubble properties such as chemical composition of bulk and surface phases, dielectric constant, dipole moment, size, size distribution, shape, surface charge, solid-phase distribution within particles, and particle anisotropy. Therefore, during the process of aggregation  $k_d$  and  $k_s$  may not remain constant. Properties of the liquid-dispersing medium that contribute significantly to the values of these rate constants are dielectric constant, dipole moment, and the ability to dissolve electrolytes and polymers, in addition to those properties cited earlier. The  $k_d$  term usually dominates in quiescent systems containing submicrometre particles. The full expression for  $(-dN/dt)$  and its use are treated in more detail elsewhere [12,13,26,312]. There are several reviews of aggregation phenomena in emulsions, foams and suspensions [13,291,313].

Chemical reactions can also affect the  $k_d$  and  $k_s$  terms and thereby influence or control colloidal stability [314]. Pertinent examples are dissolution, precipitation, hydrolysis, and chemical complexing. The last reaction may involve either simple species, e.g.,



or complicated solutes such as  $\text{Al}_8(\text{OH})_{20}^{4+}$ , chelated metals [312], synthetic and natural polymers [152,286–290], or a variety of surfactants and dispersants [32,211]. Many of the possible bulk solution chemical reactions that influence colloidal stability, along with specific sample reactions and their general interfacial analogues, are listed in Table 5.2.

**Table 5.2** Representative solution and surface equilibria influencing colloidal stability (from Schramm, [426]. Copyright 2003, Wiley).

Solution	Surface analogue
<i>Hydrolysis</i>	
$\text{CH}_3(\text{CO})\text{OCH}_3 + \text{H}_2\text{O} \rightleftharpoons \text{CH}_3(\text{CO})\text{OH} + \text{CH}_3\text{OH}$	$\text{M}_2\text{O} + \text{H}_2\text{O} \rightleftharpoons 2 \text{MOH}$
$\text{PO}_4^{3-} + \text{H}_2\text{O} \rightleftharpoons \text{HPO}_4^{2-} + \text{OH}^-$	$\text{MOH} + \text{H}_2\text{O} \rightleftharpoons \text{MOH}_2^+ + \text{OH}^-$
<i>Dissociation</i>	
$\text{Al}(\text{OH})_3 \rightleftharpoons \text{Al}^{3+} + 3 \text{OH}^-$	$\text{MOH}_2^+ \rightleftharpoons \text{MO}^- + 2 \text{H}^+$
$\text{C}_6\text{H}_5(\text{CO})\text{OH} \rightleftharpoons \text{C}_6\text{H}_5(\text{CO})\text{O}^- + \text{H}^+$	$\text{MOH} \rightleftharpoons \text{MO}^- + \text{H}^+$
<i>Dissolution</i>	
$\text{ZnC}_2\text{O}_4 (\text{s}) \rightleftharpoons \text{Zn}^{2+} + \text{C}_2\text{O}_4^{2-}$	
$\text{Al}(\text{OH})_3 (\text{s}) + \text{OH}^- \rightleftharpoons \text{AlO}_2^- + 2\text{H}_2\text{O}$	
<i>Complexation</i>	
$\text{Cu}^{2+} + 4 \text{OH}^- \rightleftharpoons \text{Cu}(\text{OH})_4^{2-}$	$\text{MO}^- + \text{Na}^+ \rightleftharpoons \text{MO}^- \text{Na}^+$
$n\text{-C}_{12}\text{H}_{25}\text{N}(\text{CH}_3)_2 + \text{H}_2\text{O} \rightleftharpoons n\text{-C}_{12}\text{H}_{25}\text{NH}^+(\text{CH}_3)_2\text{Cl}^-$	$\text{MOH} + \text{HCl} \rightleftharpoons \text{MOH}_2^+\text{Cl}^-$

For small particles, droplets, or bubbles, if the energy barrier to aggregation is removed (e.g., by adding excess electrolyte) then aggregation is diffusion controlled, with mostly Brownian motion of independent particles, droplets, or bubbles being present. (There may also be some mutual attraction causing a slight acceleration.) For a monodisperse suspension of spheres, Smoluchowski developed an equation for this “rapid coagulation” or “perikinetic coagulation”:

$$-dN/dt = k_d N^2 \quad (5.12)$$

$$n = n_0 / (1 + 8\pi D a n_0 t) \quad (5.13)$$

where  $a$  is the radius, the diffusion coefficient,  $D = kT/(6\pi\eta a)$ , and the rate constant for diffusion controlled aggregation,  $k_d = 4kT/(3\eta)$ . For aqueous dispersions at 25 °C,  $k_d = 6.13 \times 10^{-18} \text{ m}^3 \text{ s}^{-1}$  [292].

**Example.** It has been estimated that North Pacific deep water has a concentration of about  $3 \times 10^7$  particles/ml of fine particles having diameters in the range 0.01–0.5  $\mu\text{m}$ . The time in which the mass of particles originally present in the water column would be reduced by  $1/e$  of its original value, the “passage time,” has been calculated from direct observations to be on the order of 200 years. In 200 years the original concentration of particles would be reduced by perikinetic coagulation to 100 particles/ml if every collision was successful. Therefore in order to match the rate of removal actually observed for the ocean, the collision efficiency must be lower, by a factor of about  $10^{-5}$  [315]. This implies an energy barrier to aggregation.

When there is an energy barrier to aggregation there is mutual repulsion and only a fraction,  $1/W$ , of encounters lead to attachment.  $W$  is the stability ratio  $W = k_d/k_s$ , where  $k_s$  is the rate constant for slow coagulation. If the energy barrier to aggregation is electrostatic then for low values of ionic strength, a plot of  $W$  versus salt concentration, or ionic strength, will exhibit a linear decrease. This is the region of “slow coagulation”. In this region, the interaction energy and hydrodynamic viscous drag forces must be considered. For example, Alince and Van de Ven [316] studied the rate of destabilization of clay particles by pH adjustment and by cationic polyethylenimine addition. They found that the stability ratio could be correlated with the electrophoretic mobility of the clay particles and that the maximum rate of destabilization corresponded to conditions for which the electric charge on the clay particles/aggregates was nearly zero. At some value of increasing salt concentration, the plot of  $W$  versus ionic strength will usually exhibit sharp transition from the linear decrease to a plateau, or at least a region of slight decrease. The transition concentration marks the critical coagulation concentration.

Although detailed calculation of the stability ratio is quite involved [27,276,317], some approximate expressions for  $W$  have been provided. For example, an approximate expression is [28],

$$W = (1/(2\kappa a)) \exp(V_{\max}/(kT)) \quad (5.14)$$

Finally, dispersed species can also be brought into interaction distances by stirring or sedimentation where the relative motions of two adjacent regions of fluid, each carrying dispersed species, can cause an increased rate of particle encounters. Coagulation due to this influence is called orthokinetic coagulation, as distinguished from the Brownian-induced perikinetic coagulation. The theory for orthokinetic coagulation is much more complicated than that for perikinetic, and is not dealt with here. It should be remembered, however, that shear can also cause dispersion if the energy introduced allows the interaction energy barrier to be overcome.

For a given, low applied shear rate, perikinetic collision rates tend to be higher than orthokinetic rates when the dispersed species are quite small, of the order of 100 nm or less. The orthokinetic collision rates tend to dominate for larger-sized dispersed species, of the order of several  $\mu\text{m}$  or more. For more information on aggregation kinetics see Refs. [27,292,318,319].

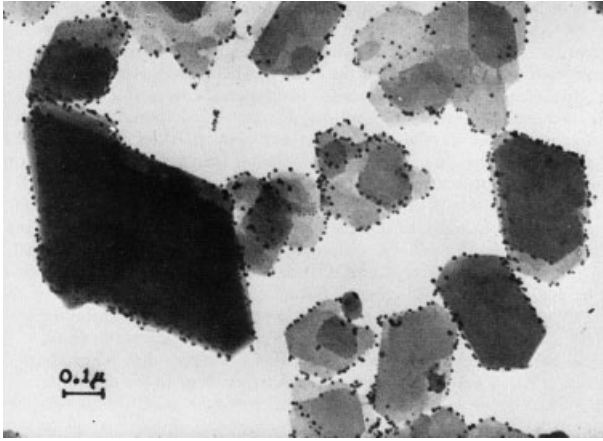
The best experimental technique for monitoring colloid stability is usually dictated by the nature of the specific colloidal material and the dispersing medium. In principle, any distinctive physical property of the colloidal system in question can be used, at least empirically, to monitor changes in the dispersed state. The more complex a system is chemically, or with respect to its particulate heterogeneity, the less likely it is that a single property uniquely and completely describes changes in the colloidal state. Aggregation and/or coalescence of colloidal material can be monitored by a wide variety of techniques including light scattering, neutron scattering, microscopy, rheology, conductivity, filtration, sedimentation, and electrokinetics.

## 5.6

### Destabilization of Colloids

The preceding sections have dealt in some detail with particle aggregation due to electric double-layer compression. Another, much simpler, category is the aggregation of dispersed species that carry opposite electric charges (termed mutual coagulation). For example, Figure 5.18 shows the result of mixing a clay particle suspension with a suspension of gold particles. Here the negatively charged gold particles have aggregated with (adsorbed onto) the positively charged clay particle edges.

Also, one needs to be aware that simply adding polymers and polyelectrolytes to a dispersion does not ensure protective action. In fact, the opposite can happen, especially if the added concentration is very low or if the polymers can form bridges across multiple dispersed species.



**Figure 5.18** Electron micrograph of a suspension containing a mixture of kaolinite and gold particles. From van Olphen [1]. Copyright 1977, Wiley-Interscience.

### 5.6.1

#### Aggregation and Flocculation

Nearly all colloidal systems undergo some aggregation on their own, leading to a distribution of aggregate sizes. Sometimes this aggregation is assisted. For example, sensitizing agents can be protective agents that are added in small amounts, producing a low polymer/dispersed species ratio. In this way, low concentrations of polyelectrolyte can promote aggregation. Again there are several possible mechanisms of action. If the additive is oppositely charged to the dispersed particles, then decreased double-layer repulsion will result. In some kinds of protecting adsorption, where a bilayer is formed with the outer layer having lyophilic groups exposed outwards, addition of enough additive to form only the single layer will have lyophobic groups oriented outwards with a sensitizing effect.

Ultramicroscopy is the preferred method for measuring the rate and/or extent of aggregation because it is direct. The indirect methods discussed in Section 2.2 can also be used when tailored to suit the specific colloidal system in hand. More than one technique is required to assess the state of aggregation when a wide range of colloidal dimensions exists. If aggregates larger than approximately  $5\ \mu\text{m}$  are present, the aggregate-size distribution can be evaluated using classical techniques such as sieving as long as such methods do not themselves induce or break aggregates.

## 5.6.2

**Structures in Flocculation**

Clay colloids provide a good example of the kinds of structures that can be formed upon flocculation. The association of plate-like clay particles is complicated by the fact that minerals such as montmorillonite, illite, and kaolinite can exhibit different surface charges at different particle surfaces.

**Example.** The clay minerals are composed [1,320] of sheets of tetrahedrally coordinated silica and sheets of octahedrally coordinated alumina or magnesia. These sheets occur stacked upon one another forming plate-like layers or particles. Montmorillonite clay, for example, occurs as relatively broad, thin platelets, typically about 0.3  $\mu\text{m}$  across and about 2 nm thick. When dispersed in aqueous solutions of near-neutral to alkaline pH, the particles carry a net negative charge. This is largely due to negative charging of the particle faces, caused by isomorphous substitution of cations of lower charge for cations of higher charge within the lattice (e.g.,  $\text{Al}^{+3}$  for  $\text{Si}^{+4}$  in tetrahedral sheets and  $\text{Fe}^{+2}$  or  $\text{Mg}^{+2}$  for  $\text{Al}^{+3}$  in the octahedral sheet). Of the various clay minerals, this is most prevalent in montmorillonite. Meanwhile, the edges of clay particles may be positive, negative, or neutral, depending upon solution pH and the degree of protonation of various atoms exposed at the edges. Figure 5.18 shows an electron microscope picture of a suspension of kaolinite clay particles with which a suspension of gold particles had been mixed. The gold particles, being negatively charged, have adsorbed onto the positively charged clay particle surfaces. The picture shows that the regions of positive charge are almost exclusively located at the clay particle edges.

This heterogeneous charge distribution leads to a number of kinds of particle interaction orientations that are possible for clay suspensions, as shown in Figure 1.7. Three basic modes are possible: face-to-face (FF), edge-to-face (EF), and edge-to-edge (EE). The different modes can be combined in different ways depending upon the clay mineralogy (montmorillonite has higher negative charge density than kaolinite, for which the positive edge charging can be more significant), solution pH (directly determining the contributions from edge charging), solution ionic composition and solution ionic strength (both of which affect aggregation overall and also the number of plates per tactoid in aggregates, see references [321,322]).

More information on mineralogy and its effect on particle charges can be found in Refs. [1,49,320–322]. The EE and FF aggregation results from the overlapping of similar electrical double layers, while the EF aggregation results from the overlapping of dissimilar electrical double layers. EF association (heterocoagulation) involves positive and negative surfaces, respectively, so there is no potential energy barrier to aggregation. This makes the EF heterocoagulation rapid. The EE and FF kinds of aggregation, since they involve similar charges, are influenced by a potential energy barrier. Thus, EE and FF aggregation tends to be very slow unless there is sufficient electrolyte to reduce the energy barrier. For each type of association the van der Waals forces will vary, being greatest for the FF type (FF aggregation tends to have the lowest primary minimum).

The rates of coagulation for the different types of association differ from each other. The EE aggregation is generally the fastest, since it involves the largest collision diameter (the platelet diameter). The FF aggregation is generally the slowest, since it involves the smallest collision diameter (the platelet thickness). Also, the three types of associations will not necessarily occur together or at the same rates when the clay flocculates [49].

In terms of structure, the FF association leads to the build-up of successively larger stacks of particles called oriented aggregates, or tactoids [321–323]. The EE and EF associations produce flocs and can lead to voluminous, three-dimensional assemblages, often described as “card-house” structures. Figure 1.7 provides an illustration of these modes of interaction. Descriptions of the details surrounding the transitions from one structure to another are given by van Olphen [1].

The different kinds of particle associations in aggregation have an important consequence in that they can also strongly influence sediment volumes. The sediments formed from stable suspensions are much more compact than those of flocculated suspensions (see Figure 2.19). When particles in a stable suspension settle they are able to move past each other and realign quite easily, aided in part by their mutual repulsion, and can become quite closely packed into a dense sediment. In a flocculated suspension, on the other hand, the settling particle flocs will tend to congregate into a voluminous sediment containing large void spaces. This generalization breaks down when gravity (for large particles) or other forces (like centrifugal) can break the particle–particle linkages that exist in flocculated structures. Nevertheless, there are many practical situations in both natural and formulated dispersion occurrence for which floc structure determines sediment volumes. Figure 5.19 shows an example involving sodium-form montmorillonite particles. It can be seen that the addition of a few milli-equivalents of sodium chloride to this suspension causes a flocculated structure to become peptized, which in turn causes significant decreases in sediment volumes and yield stress. Addition of more salt causes these properties to increase again as the suspension becomes re-flocculated, this time into a different structure [1].

### 5.6.3

#### **Bridging Flocculation**

Flocculation of particles, droplets, or bubbles may also be achieved through the addition of high molar mass polymers to a dispersion. These molecules act as bridging agents by adsorbing onto more than one dispersed species at a time with a significant portion of the polymer chain still remaining in the aqueous phase. The bridging action causes the formation of porous flocs. The molecules have to be quite large and have at least two regions of the molecule available for adsorption. This can happen in static, concentrated dispersions for which dispersed species are in relatively close proximity and remain close to each other for a sufficiently long period of time to permit the dual adsorption. Bridging flocculation can also occur when, for example, any of proteins, casein micelles, xanthan gum or polysaccharides bridge between droplets in food emulsions [78,291]. An example can be found in the induc-

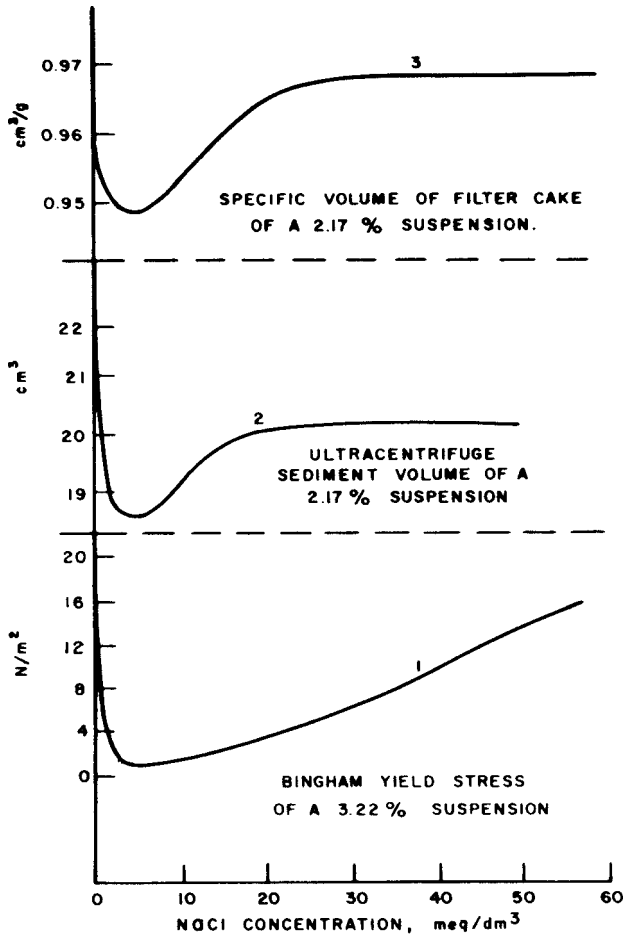


Figure 5.19 The specific volume of filter cake, sediment volume, and Bingham yield stress of sodium montmorillonite sols as a function of the NaCl concentration. From van Olphen [1]. Copyright 1977, Wiley-Interscience.

tion of clustering of droplets in non-dairy creams in order to increase viscosity and partially gel the cream, and casein molecules and fat crystals can combine to cause bridging flocculation in food emulsions (see Section 13.5). Process changes can also cause bridging flocculation, such as when a suspension of particles that are covered by polymer adsorption layers is mixed with a suspension of uncovered particles [291].

The formation of flocs due to bridging flocculation has a dramatic effect on sedimentation rates, sediment volumes, and on the ease of filtration. Effective flocculation may occur over a narrow range of polymer concentration because too little polymer will not permit floc formation, while too much polymer adsorption will eliminate the fraction of free particle surface needed for the bridging action (i.e., the poly-

mer molecules will adsorb onto single particles in preference to bridging several particles). It has been proposed that the optimum degree of bridging flocculation may occur when particle surfaces are half covered with adsorbed polymer, providing the greatest opportunities for polymer bridging [292]. The nature of the flocculation is quite dependent on experimental conditions such as the nature and degree of agitation that may be present. Colloidal destabilization by electrolytes and bridging flocculation by polymers have been addressed both experimentally and theoretically [286–290].

Bridging flocculation can sometimes be prevented or destroyed by adding surfactant in sufficient quantity to adsorb and cover all of the interfaces in a system, thus displacing the bridging molecules from at least one of each pair of interfaces.

#### 5.6.4

##### **Agglomeration Flocculation**

The addition of a second, immiscible liquid to a suspension can cause flocculation if the second liquid preferentially adheres to the particles and bridges between them. This is called agglomeration. Depending upon the amount of bridging liquid added, and the degree of agitation present, the particles may agglomerate in the form of flocs, or large rounded lumps (“spherical agglomeration”), or they may become completely transferred into the second liquid phase [324–326]. Any of these forms may provide the solution to a particular solids separation problem. In some cases, surfactants may be added to ensure that the solids become fully wetted by the second liquid, or to provide a selective separation of one kind of solid over another.

Examples of the kinds of fine solids that have been separated from suspension in the form of flocs or spherical agglomerates include phosphate ore particles from water, calcium phosphate from phosphoric acid, soot from various aqueous process streams, coal particles from coal-washing slurry, and iron ore from aqueous tailings [324–326].

#### 5.6.5

##### **Depletion Flocculation**

When a liquid dispersion contains non-adsorbing polymers there will be a layer of liquid surrounding each dispersed species that is depleted in polymer, compared with the concentration in bulk, solution. This causes an increase in osmotic pressure in the system compared with what it would be were the dispersed species absent. If the dispersed species move close to each other then the volume of solvent depleted is reduced, reducing the overall osmotic pressure, which provides a driving force for flocculation. Xanthan gum, added in low concentrations, can cause depletion flocculation [291].



## 5.6.6

**Filtration**

The foregoing discussions of flocculation are important to the process of filtration because the properties of a filter cake depend on the degree of dispersion, including flocculation, of the dispersion being filtered [1]. Thin, compact filter cakes tend to result from the filtration of stable, well-dispersed particles. The permeability of compact filter cakes is quite low, so the rate of the filtration process tends to be self-slowing in this case. In contrast, thick, porous filter cakes tend to result from the filtration of flocculated suspensions. The permeability of porous filter cakes is, of course, quite high, so it is much easier to maintain an acceptable rate of filtration in this case. It should be noted that, if the suspension particles are small enough to enter and clog the pores of the filter medium, then the filtration rate may rapidly decline, almost independently of the stability considerations.

## 5.6.7

**Foam Stability in the Presence of Oil**

Among the many available defoamers, crude oil has been used to prevent the formation of foams, or destroy foams already generated, in a variety of industrial processes [43,46,327]. Crude oil can also destabilize foams applied in petroleum reservoirs, i.e., foams in porous media [3,306,328–331] (see Section 11.2.2). Although crude oils tend to act as defoamers, foams actually exhibit a wide range of sensitivities to the presence of oils, and some foams are very resistant to oil [3,332,333]. Many system variables influence the oil tolerance of a given foam and many attempts have been made to correlate foam-oil sensitivity with physical parameters [307,332–337]. These have met with mixed success [114,338].

Foams occur or are created throughout the full range of processes in many industries. In the petroleum industry they occur from drilling through production, refining, transportation, and fire-fighting. The foams can be either aqueous or oleic, although the former are by far the most common, and may be desirable in some process contexts and undesirable in others (see Table 11.1). The undesirable foams need to be broken or have their formation prevented. Conversely, desirable foams usually need a certain degree of oil tolerance in order to have the necessary overall stability to perform their intended function. This applies even to the oil-based foams which, at the very least, risk having their continuous phase being diluted to the point at which their foam stabilizers cease to be effective.

A major difficulty is the proper selection of foam-forming surfactants for the challenging environments involved in petroleum reservoir applications, since many characteristics are thought to be necessary for performance, including good tolerance of the foam to interaction with crude oil in porous media [3,306]. Here the physical situation is even more complex than for bulk foams due to influences of pore structure, wettability, and oil saturation. For both bulk foams and foams in porous media, oil-sensitive foams are usually less stable as increasing amounts of emulsified oil are contacted (bulk tests) or in the presence of increasing oil satura-

tions (porous medium tests). Oil-sensitive foams are generally less stable in the presence of lighter (lower density) crude oils than heavier [3,339]. Here again, some foams are quite stable in the presence of light through heavy crude oils [307], using either relatively pure foaming agents (usually quite expensive), or else with specially formulated mixtures, which can be cost-competitive with traditional foaming agents (e.g., [340,341]).

There are several mechanisms by which bulk foams can be destabilized by oils, and more than one mechanism may be involved in any given situation.

#### **Adsorption of Stabilizing and Destabilizing Components**

Foam-forming surfactant may be absorbed or adsorbed by the oil, especially if there is emulsification, causing depletion from the gas/liquid interface. Natural surfactants from the oil may be adsorbed by the foam lamellae, forming either a mixed or replaced adsorption layer and producing a less favourable state for foaming. In a reservoir application, components from the oil may be adsorbed by the porous medium altering the wettability of the solid phase and making it more difficult for foam to be generated and regenerated.

#### **Spreading and Entering Coefficients**

From thermodynamics, an oil is predicted to spread as a lens over a foam when the spreading coefficient,  $S$ , is positive [114]. Rapid spreading of a drop of oil over a foam lamella can cause rupture by providing a weak spot. Similarly, an oil droplet is predicted to be drawn up into and bridge the lamellar region between two adjacent bubbles, breaching the aqueous/gas interface, when the entering coefficient,  $E$ , is positive. If the oil breaches the interface this usually causes the interfacial film to lose its foam stabilizing capability and thin to the rupture point, although “entering” does not always destabilize a foam. If  $E$  is negative, the oil should be ejected from the lamellar region and not destabilize the foam by this mechanism. Several authors have suggested predicting defoaming action by considering the possible combinations of values of  $S$  and  $E$  [114,329].

Spreading and entering coefficients have been applied to both bulk foams and to foams flowing in constraining media and, in general, correlate best for the former. Reasonably good correlations have been found in most of the micro-visual studies conducted [3,114,328,331,342] but only a few core-flood studies [329]. Although a very large negative value for  $S$  seems to fairly reliably distinguish the very oil-tolerant (stable) foams from the rest, neither  $S$  nor  $E$  reliably distinguish the varying degrees of foam tolerance to oil [114,330]. The main limitation of the spreading and entering coefficient approach is that it assumes thermodynamic equilibrium throughout, whereas foams, especially flowing foams, tend to be quite dynamic systems.

#### **Emulsification and Imbibition Models**

Oil droplet size is thought to be quite important to the effectiveness of crude oils at destabilizing foams, with smaller droplets being the more effective [44,114,330,342]. A number of microvisual and core-flood studies suggest that the emulsification/imbibition of oil into foam can be a very important factor [44,114,328,330,339,342].

Figure 1.5 shows an example of an aqueous foam with emulsified and imbibed crude oil droplets residing in its plateau borders. Using a simple model the degree of emulsification and imbibition has been found to correlate quite well with foam sensitivity to oil for a wide variety of foams, oils, and conditions [114]. A limitation of emulsification/imbibition models is that they will only be important for foam lamellae that are thick enough to accommodate realistic emulsion droplet sizes. Typical foam lamellae in porous media appear to have thicknesses on the order of tens of  $\mu\text{m}$  [70,71,114,328].

#### **Pseudoemulsion Film Model**

The thin liquid films bounded by gas on one side and by oil on the other, denoted air/water/oil are referred to as pseudoemulsion films [301]. They are important because the pseudoemulsion film can be metastable in a dynamic system even when the thermodynamic entering coefficient is greater than zero. Several groups [301,331,342] have interpreted foam destabilization by oils in terms of pseudoemulsion film stabilities [114]. This is done based on disjoining pressures in the films, which may be measured experimentally [330] or calculated from electrostatic and dispersion forces [331]. The pseudoemulsion model has been applied to both bulk foams and to foams flowing in porous media.

Micro-visual studies have demonstrated the actions of spreading and entering, emulsification and imbibition, and pseudoemulsion film thinning in foam lamellae [3,328,331]. Comparisons among core-flood results from the literature are difficult because a wide range of experimental procedures, materials, conditions, and performance measures have been used [3]. For example, the wetting preference of the porous medium has a significant effect on foam sensitivity to oil [329,343]. Overall it is clear that some foams, that are otherwise quite stable while flowing in porous media, are not stable in the presence of a significant residual oil saturation (i.e., greater than 10–15%) [329,330,339,344].

Ultimately, the evaluation of foam effectiveness includes numerical simulations and field tests [345]. The concept of a critical foaming oil saturation, a residual oil saturation above which the foams are not stable and will not propagate, has been incorporated into reservoir foam-flood simulations [5,344,346], and field tests are increasingly being designed using oil-tolerant foams [347]. It is emphasized that this applies to most but not all foams, since some foams are stable and can propagate at higher residual oil saturations and some foams are not oil-sensitive at all. In this context, several researchers [3,339,348] have suggested that, with proper foam selection, controlled emulsification and imbibition of oil into foam can be used to improve microscopic displacement efficiency, and therefore as a mechanism for improved oil recovery.

In summary, many foams are completely unstable in the presence of oil, many others are moderately unstable in the presence of oil, and some foams are very stable in the presence of oil. Much is known about the factors contributing to foam-oil sensitivity, but attempts at correlation with independent physical parameters have met with mixed success.

## 6 Colloid Rheology



**Figure 6.1** Cut-away illustration of fluid in a concentric cylinder rheometer. Courtesy G. Schramm [349]. Copyright 1981, Gebrüder Haake GmbH.

When stresses are applied to ideal gases or liquids they deform irreversibly. The gas or liquid flows and can be considered to be viscous. Viscosity can be thought of as the resistance of a fluid to flow. When a stress is applied to an ideal solid it deforms reversibly, i.e., the solid regains its original state and thus can be considered to be elastic. The discussion of the flow of matter is simplest for model systems such as Newtonian fluids and perfectly elastic solids. These two model systems represent the extremes of rheological behaviour. However, many liquids and solids are not ideal and exhibit a combination of viscous and elastic properties. Furthermore, when a given stress is applied to different materials the resulting deformations can be very different. Rheology is the science of the deformation and flow of matter.

The rheological properties of a dispersion are very important. High viscosity may be the reason that a dispersion is troublesome, a resistance to flow that must be dealt with, or a desirable property for which a dispersion is formulated. From

Stokes' law the terminal settling velocity is inversely proportional to the viscosity of a colloidal dispersion, which has a direct impact on sedimentation in the treatment of waste water, in mineral fractionation, and in flotation [91,350]. Another major application area is transport behaviour, involving the pumping of fluid systems containing colloids, such as in extrusion in the polymer industry, the processing of gelatinous foods and cosmetic items, the fabrication of high-performance materials in the ceramic and metallurgical industries, transportation in the petroleum industry, and the preparation and handling of pigment slurries in the paint industry. The prediction and control of emulsion, foam, and suspension rheology, especially the thixotropic and dilatant tendencies, is primarily important for these and other uses.

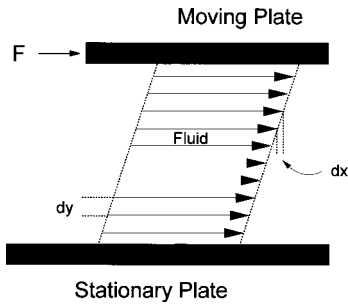
Industrial process streams are frequently treated as being "single phase" fluids, having simple properties of viscosity and density for calculations involving pumping, mass transfer, etc. In fact most industrial process streams occur as dispersions of two or more phases as discussed in earlier chapters. Dispersed phases introduce complications such that, in many cases, the viscosity is not expressed by a single number at constant temperature and pressure, but also depends upon whether the material is flowing, and even its recent history!

**Example.** Consider the observed properties of bituminous froth produced in the oil sands hot water flotation process. When fresh, the froth is very viscous when stagnant (hard to pump) but becomes less viscous (twice as easy to pump) when it is flowing. As it is handled, or stored, the entrained air is released and it becomes less viscous (eventually six times as easy to pump). Its viscosity, whether fresh or aged, is exponentially related to temperature so that upon cooling from process temperature to ambient temperature it becomes 50–200 times more difficult to pump.

You have a pump that was designed to handle fresh, flowing froth at a process temperature of 80 °C, but there is a process interruption and the pump is halted for two days, during which time the whole circuit cools to the treatment plant's ambient temperature of about 20 °C. What will happen when you eventually try to restart the pump?

## 6.1 Principles

Consider a fluid that is contained between parallel plates as shown in Figure 6.2. The fluid can be made to flow as follows. If the upper plate is moved, it exerts a force across the nearest plane layer of fluid. Depending on the force per unit area ( $F/A$ ) some deformation is produced (parallel to the plane). If the fluid is visualized as a set of thin plane layers, the uppermost layer will move with the plate while the lowermost layer remains motionless (no-slip condition). Intermediate layers will have intermediate velocities. The flow situation just described is termed laminar flow (turbulent flow is discussed in Section 10.3.1). The distance between adjacent layers is  $dy$  and between adjacent layers, there exists a velocity difference,  $dV$ , thus a velocity gradient  $dV/dy$ . This velocity gradient arises out of a competition between the applied force per unit area ( $F/A$ ) and an internal resistance provided by the fluid,



**Figure 6.2** Illustration of deformations produced between parallel plates when the upper plate, of surface area  $A$ , is moved in response to a force  $F$ .

which is highly dependent on the nature of the fluid. Newton's Law of Viscosity states that:

$$F/A \propto dV/dy \quad (6.1)$$

Equation (6.1) can be rewritten as:

$$F/A = \eta(dV/dy) \quad (6.2)$$

where  $\eta$  is the coefficient of **viscosity** (units of  $\text{mPa} \cdot \text{s}$ ) and represents the internal resistance to flow of the fluid.

By introducing some terminology, Eq. (6.2) can be placed in a more familiar form. The force per area in the plane is termed the **shear stress** ( $\tau$ ). The displacement of a plane layer ( $dx$ ) over the separation between layers ( $dy$ ) is termed the shear ( $dx/dy$ ) acting on the fluid. Now since  $dV = d(dx/dt)$ ,

$$dV/dy = d(dx/dy)/dt \quad (6.3)$$

The derivative  $dV/dy$  is termed the **shear rate** ( $\dot{\gamma}$ ). Substituting the shear rate into Eq. (6.2) yields:

$$\tau = \eta \dot{\gamma} \quad (6.4)$$

Clearly, the coefficient of viscosity should have units of  $\text{mass} \cdot \text{length}^{-1} \cdot \text{time}^{-1}$ . In SI units we have  $\tau$  in Pa,  $\dot{\gamma}$  in  $\text{s}^{-1}$ , and hence  $\eta$  is expressed in units of  $\text{Pa} \cdot \text{s}$ . Table 6.1 shows some fairly common fluids having widely varying viscosities.

**Table 6.1** Approximate viscosities of some materials at room temperature.

Material	Viscosity, 20 °C (mPa·s)
Air	$10^{-2}$
Ether	$10^{-1}$
Water	$10^0$
Blood	$10^1$
Engine oil (10W30)	$10^2$
Glycerin	$10^3$
Honey	$10^4$
Bitumen (Athabasca)	$10^5$
Cheddar cheese	$10^8$
Gelatine	$10^9$
Ice	$10^{16}$

In turbulent flow there is mixing of the moving layers and the fluid resists distortion to a greater degree than in laminar flow, therefore the viscosity is greater. For turbulent flow, Eq. (6.4) becomes:

$$\tau = (\eta + \mu) \dot{\gamma} \quad (6.5)$$

Here  $\mu$  is termed the eddy viscosity, which describes the internal friction developed as the laminar flow passes around irregularities and becomes turbulent. Laminar and turbulent flow are distinguished using the Reynolds number,  $N_R$ :

$$N_R = \rho(VR/\eta) \quad (6.6)$$

where  $\rho$  is the density,  $V$  is the mean velocity of flow, and  $R$  is the characteristic length. The characteristic length depends on the situation and may be the diameter of a pipe or the depth of a river. The flow for water in a pipe is laminar when  $N_R < 2100$  and turbulent when  $N_R > 2100$ . For other fluids, or for other physical situations, the transition values are different but, in general, laminar flow occurs for low Reynolds numbers and turbulent flow for high Reynolds numbers.

Equation (6.4) is applicable to a description of the flow behaviour of ideal fluids, or **Newtonian** fluids. Examples include water, mineral oils, bitumen, and molasses. However, many fluids, especially colloidal dispersions, do not obey Eq. (6.4), usually due to the mutual orienting and even structure formation of the dispersed species in the flow.

Due to polydispersity, high dispersed phase content, mutual orienting and/or structure formation of the dispersed species under flow, a non-Newtonian dispersion exhibits a viscosity that is not a constant, but is itself a function of the shear rate, thus:

$$\tau = \eta(\dot{\gamma}) \dot{\gamma} \quad (6.7)$$

The function itself can take many forms [351–356]. To specify the viscosity of a non-Newtonian fluid, it is essential also to specify the shear rate to which it applies. It is common for industrial pumping and processing equipment to employ shear rates that fall in the intermediate shear regime from about 1 to 1000  $\text{s}^{-1}$ . Table 6.2 gives some examples. Table 6.3 gives an example of the range of viscosities that can be encountered at different stages in a processing industry.

**Table 6.2** Some approximate values of shear rate appropriate to various processes.

Process	Approximate shear rate ( $\text{s}^{-1}$ )
Very slow stirring	0.01–0.1
Reservoir flow in oil recovery	1–5
Mixing	10–100
Pumping	100–1000
Brushing, Coating	10 000
Spraying	100 000

Sources: Refs. [93,349].

**Table 6.3** Range of viscosities encountered in the flotation recovery of bitumen from Canadian oil sands. Viscosities are either essentially Newtonian (N) or else are reported for a reference shear rate.

Material or process stream	Approximate viscosity (mPa·s)	Shear rate ( $\text{s}^{-1}$ )	Temperature ( $^{\circ}\text{C}$ )
Bitumen in oil sand	$3.75 \times 10^5$	N	15
Primary flotation vessel slurry	$2.0 \times 10^1$	4000	80
Process water	$3.5 \times 10^{-1}$	N	80
Bituminous froth	$2.0 \times 10^3$	58	80
Deaerated bituminous froth	$5.0 \times 10^2$	N	80
Naphtha	$2.5 \times 10^{-1}$	N	80
Naphtha diluted froth	$6.0 \times 10^0$	N	80
Bitumen from process	$5.0 \times 10^2$	N	80
Tailings pond sludge	$1.0 \times 10^1$	2770	4
Synthetic crude oil	$2.8 \times 10^0$	N	40

## 6.2 Measurement

There are a number of types of rheological measurement, some are appropriate for Newtonian fluids only, while others may be used for Newtonian or non-Newtonian fluids. Some of the principal types are listed in Table 6.4. Some very useful descriptions of experimental techniques have been given by Whorlow [355] and others [215,352,353,356,357]. The principal methods are discussed in the next several sections.



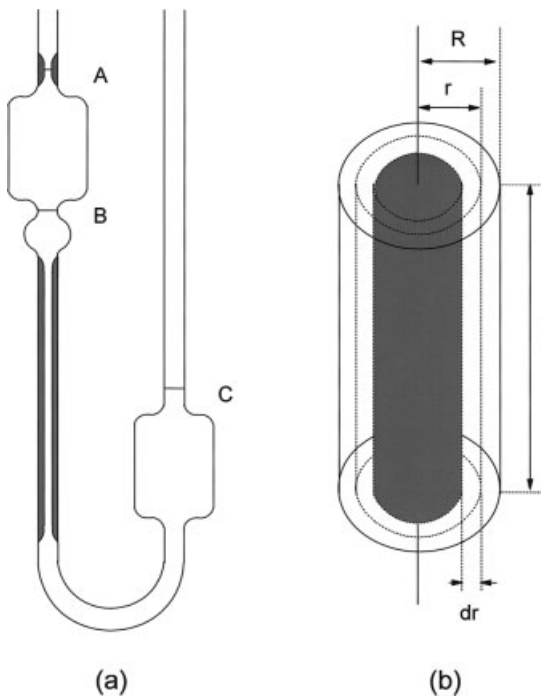
**Table 6.4** A simple classification of rheological methods.

Method class	Examples	Applicability to fluids	Section
Tube methods	Capillary viscometers	Newtonian	6.2.1
	Pressure capillary viscometers	Newtonian	6.2.1
	Pulse capillary viscometers	Non-Newtonian	6.2.1
	Orifice viscometers	Newtonian	6.2.1
Rotational methods	Concentric cylinder viscometers	Non-Newtonian	6.2.2
	Cone and plate viscometers	Non-Newtonian	6.2.2
Other methods	Falling ball viscometers	Newtonian	6.2.3
	Oscillation viscometers	Newtonian	6.2.3

## 6.2.1

**Tube Methods**

A common method for measuring the viscosity of Newtonian liquids involves the use of gravity force capillary viscometers. A simple capillary viscometer is illustrated in Figure 6.3(a). The viscometer is filled with a sample so that by applying suction one meniscus can be held above point A while the other is below point C. After



**Figure 6.3** Illustration of (a) an Ostwald viscometer and (b) a co-ordinate system showing the position of concentric flow layers.

releasing the suction one measures the time required for the liquid meniscus to fall between points A and B. The long, narrow capillary helps to approximate steady, laminar flow, while the bulb reservoirs help to approximate a constant hydrostatic pressure. In addition to the Ostwald-style viscometer shown in Figure 6.3(a) a number of other styles are available to accommodate transparent or opaque fluids and different viscosity ranges, many of them having their own names such as Ubbelohde and Cannon–Fenske, see Refs. [349] and [358] for examples.

To understand how gravity force capillary viscometers work, consider the layers of fluid that we previously drew between parallel plates (Figure 6.2) now to be concentric layers in a cylinder as sketched in Figure 6.3(b). If each layer has radius  $r$ , thickness  $dr$ , and the “no slip” condition holds at the walls, then the velocity of each layer is zero at the outer wall and increases toward the center. The viscous force on the shell is given by the force per unit area ( $\eta dv/dr$ ) times the area ( $2\pi rl$ ) so that in a steady flow condition:

$$\begin{aligned} \text{Viscous force on shell} &= \text{Gravitational force} + \text{Pressure force} \\ \eta (2\pi rl)(dv/dr) \Big|_r^{r+dr} &= 2\pi l \rho g r \, dr + 2\pi \Delta P r \, dr \end{aligned} \quad (6.8)$$

Integrating Eq. (6.8) twice and evaluating for the boundary conditions yields the classic parabolic velocity profile given by:

$$v = (\rho g + \Delta P/l)(r^2 - R^2) / 4\eta \quad (6.9)$$

This is for the shell at  $r$ . The total volumetric flow is  $v$  times the cross-sectional area of the shell integrated from 0 to  $R$  (Poiseuille’s law):

$$V/t = (\rho g l + \Delta P)(\pi R^4) / (8\eta l) \quad (6.10)$$

In gravity force capillary viscometers the bulb reservoirs help to approximate a constant hydrostatic pressure, so Equation 6.10 reduces to:

$$\eta = C \rho \Delta t \quad (6.11)$$

where the constant  $C$  includes all the apparatus terms and is evaluated by calibrating with standard liquids of known viscosity and density.

Where tube methods are used, an often-encountered viscosity parameter is the kinematic viscosity. It is determined from the same measurement as above, but without requiring any knowledge of the density:

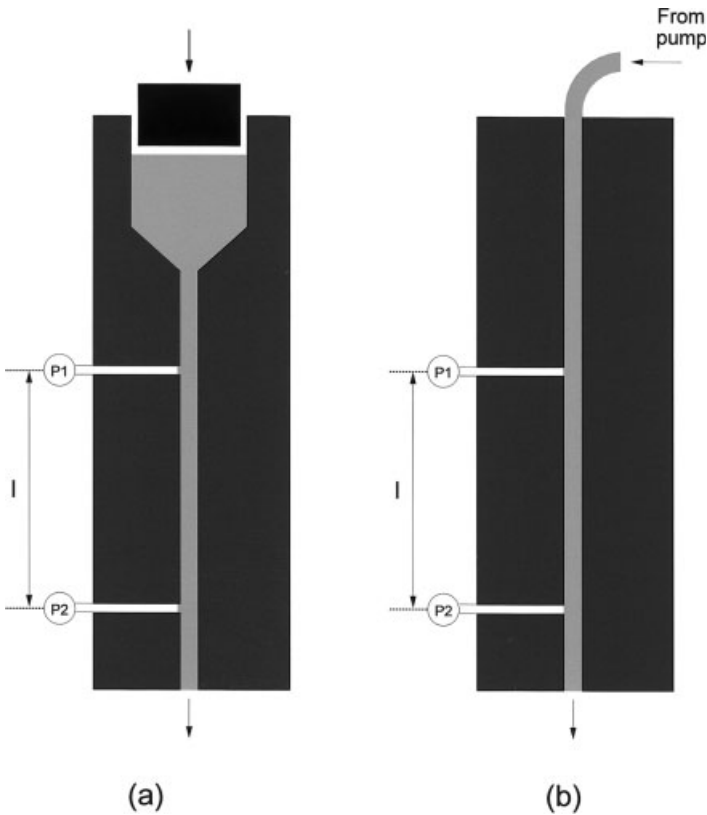
$$v = C \Delta t = \eta / \rho \quad (6.12)$$

The unit of kinematic viscosity is  $\text{m}^2/\text{s}$  but it should be recognized that much of the older literature refers to a different unit of kinematic viscosity, the Stoke (St) or centi Stoke (cSt);  $1 \text{ mm}^2/\text{s} = 1 \text{ cSt}$ .

For non-Newtonian liquids the capillary viscometer is inappropriate, although in principle capillary viscometers of different internal radii could be used to give data for different average shear rates. A very wide range of such averages would be needed. In practice a concentric cylinder or related rheometer is used instead.

In a pressure capillary viscometer, such as a rheological die, pressure is used to force fluid through a capillary tube at constant volumetric flow rate  $Q$ , as shown in Figure 6.4. The pressure difference  $\Delta P$  is measured between points A and B spaced apart a distance  $l$  along the tube. The basic rheological equations are as follows for shear stress and shear rate taken to be very near the wall in a tube of radius  $r$ :

$$\begin{aligned}\tau &= r\Delta P/(2\Delta l) \\ \dot{\gamma} &= 4Q/(\pi r^3) \\ \eta &= \Delta P\pi r^4/(8Q\Delta l) = \text{constant} \times \Delta P/Q\end{aligned}\quad (6.13)$$



**Figure 6.4** Illustration of two pressure capillary viscometers, or rheological dies.

Equation (6.13) is the Poiseuille equation. It shows that injecting a fluid at a given flow rate and measuring the pressure drop along the length  $l$  is sufficient to determine the (Newtonian) viscosity if the tubing constant is known. These equations also apply to pipelines. Corresponding equations for a number of non-Newtonian fluid types are available in the literature [355,359]; they tend to be somewhat unwieldy and require a knowledge of the fluid rheology. Equation (6.13) also applies to the flow of dispersions in tubes and pipes as illustrated in Section 6.6.1. A variation of pipe flow rheometry for high pressures and temperatures, using a rotating hollow wheel, has been described by Johnsen and Rønningsen [360].

If the capillary has a slit cross-section of thickness  $h$ , which is very small compared with the slit width  $w$ , then the basic rheological equations are as follows for shear stress and shear rate taken to be very near the wall:

$$\begin{aligned}\tau &= h\Delta P/(2\Delta l) \\ \dot{\gamma} &= 6Q/(wh^2) \\ \eta &= \Delta Pwh^3/(12Q\Delta l) = \text{constant} \times \Delta P/Q\end{aligned}\quad (6.14)$$

A range of orifice viscometers are available which function like gravity force or pressure driven capillary viscometers, except that the fluids are placed in cups (either by filling or dipping) and then forced through an exit orifice only and do not flow along a capillary tube or, at best, only along a short capillary tube. Orifice viscometers are known under a variety of names in different industries, e.g., melt indexes for polymer melts. The orifice can be considered to be a capillary tube of extremely short length, short enough that steady state and laminar flow are not achieved. There is an acceleration of fluid into the orifice, as well as a combination of turbulence and exit effects in these systems. A parameter is determined by measuring the time required for a volume of fluid to pass through the orifice, or vice versa. However, because Newton's Law cannot be applied these devices do not measure absolute viscosity. Instead, a number of non-viscosity parameters and units have evolved, including the Zahn- or Shell-seconds [361], Ford-cup seconds [362], Engler degrees, Saybolt universal- and Saybolt furol-seconds [363], Redwood seconds, and Marsh funnel seconds. For many of these there exist cup-specific formulae for converting flow times to approximate kinematic viscosities [361–363]. Some approximate conversions for viscous fluids are shown in Table 6.5. Despite the questionable application of such devices to absolute viscosity measurement, their simplicity, ruggedness and low cost make them attractive for use in industrial plants and similar situations where quality or process control applications really only require viscosity comparisons among similar fluid types. For example, the Marsh funnel, a funnel-shaped orifice viscometer, is commonly used to measure the viscosity of drilling fluid samples at drilling rig sites [359].

**Table 6.5** Some approximate viscosity conversions for viscous fluids.

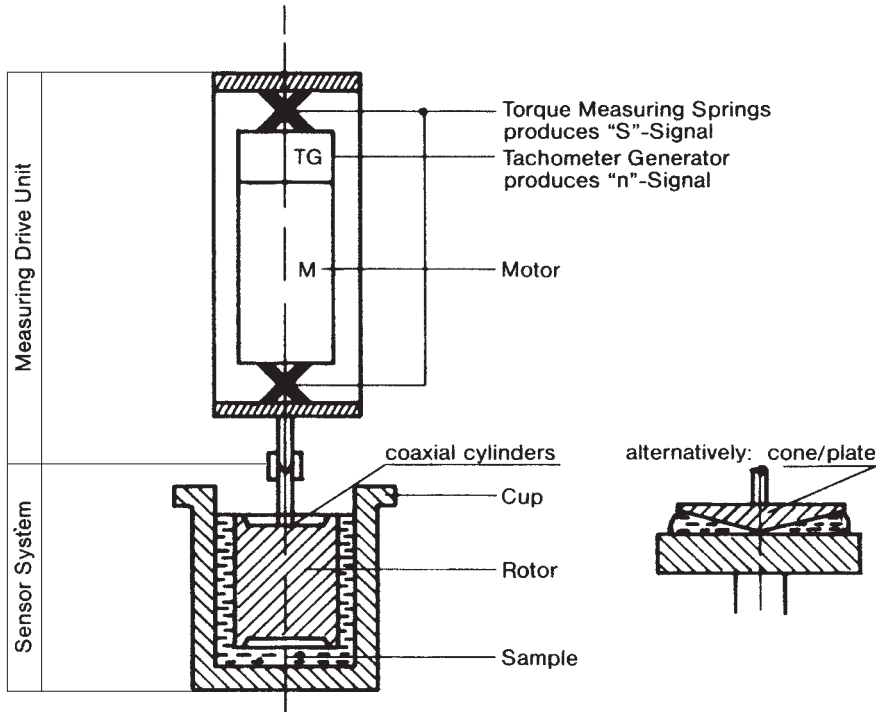
Method	Unit	Approximate equivalent	Applicable viscosity range
Saybolt Universal	seconds	cSt $\times$ 4.55	> 50 cSt
Engler	degrees	cSt $\times$ 0.132	> 50 cSt
Redwood #1	seconds	cSt $\times$ 4.05	> 50 cSt

Source: Stewart, S. A., A Glossary of Urethane Industry Terms, The Martin Sweets Co., Louisville, KY, 1991.

### 6.2.2

#### Rotational methods

Measurement of the flow properties of non-Newtonian fluids is typically accomplished via rotational techniques. The rotational methods fall into two basic types, concentric cylinder and cone and plate rheometers. In a concentric cylinder rheometer, a bob is placed inside a cylinder so that the fluid to be studied may be placed into the gap between the cylinders. This arrangement helps approximate a uniform shear rate throughout a sample by shearing only a thin film of sample fluid between



**Figure 6.5** Illustration of a Searle-type rheometer with a concentric cylinder sensor; to the right a cone and plate sensor. Courtesy G. Schramm [349]. Copyright 1981, Gebrüder Haake GmbH.

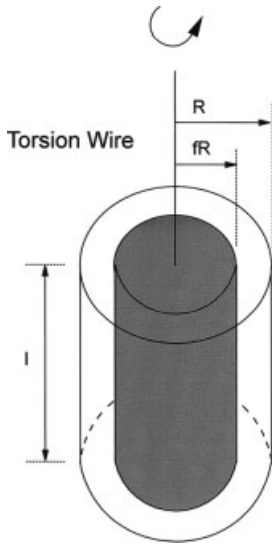


Figure 6.6 Geometry of a Searle-type concentric cylinder sensor.

the cylinders. In the Searle method the inner cylinder is rotated so that interchangeable bobs can be used (to vary the gap). The outer cylinder does not rotate making it easier to apply a temperature control jacket. In the Couette method the outer cylinder turns. In each case, the torque on the inner bob is measured.

Figure 6.5 shows a Searle-type arrangement in which a sample is placed into the gap between the cylinders. An illustration of the geometry of the cylinders is given in Figure 6.6, in which the outer cylinder has an internal radius of  $R$  while the inner cylinder has a radius of  $fR$ ; the gap dimension is  $R(1-f)$ . The motor causes the inner cylinder to rotate while a measuring spring allows the torque produced at the inner cylinder to be measured. If the earlier example of fluid layers between parallel plates were wrapped into a closed ring around the  $z$ -axis, the concentric cylinder arrangement would result. If  $r$  is radial distance,  $dr$  the thickness of a small fluid layer, and  $\omega$  the angular velocity, then the gradient across the gap is  $(r \, d\omega/dr)$ . The viscous force acting on a cylindrical shell of fluid of length  $l$  is:

$$F = \eta A \, (dv/dr) = \eta (2\pi r l)(r \, d\omega/dr) \quad (6.15)$$

The torque on the torsion wire is:

$$T = rF = 2\pi \eta l r^3 \, (d\omega/dr) = \text{constant at steady flow} \quad (6.16)$$

This can be integrated to yield the torque at the inner cylinder wall:

$$T = RF = 4\pi \eta l (fR)^2 \omega \left( \frac{f^2}{1-f^2} \right) \quad (6.17)$$

This equation can be used to measure viscosity since all the parameters can be determined independently. The shear rate can be varied by changing the angular velocity. The shear rate at the inner wall is given by:

$$\dot{\gamma} = 2 \omega (f^2/(1-f^2)) \quad (6.18)$$

for an inner cylinder turning at a speed of  $n$  revolutions per minute, this equation becomes:

$$\dot{\gamma} = (n\pi/15) (f^2/(1-f^2)) \quad (6.19)$$

From the above equations we can obtain the shear stress at the inner cylinder wall as:

$$\tau = T/\{2\pi l(fR)^2\} \quad (6.20)$$

In this technique, the shear stresses (and viscosities) can be determined at different shear rates by changing the gap or, more typically, changing the angular velocities. But since  $r^2(d\omega/dr) = r^2(dV/dr)$  is constant across the gap (not  $dV/dr$ ), it is the average shear rate that changes. Experimentally, small gaps are used to minimize the variation. To approximate a linear velocity gradient across the gap the inner cylinder to outer bob radius ratio,  $1/f$ , must be less than about 1.1. In most cases this will allow measurements to within 3% of the true viscosity. A small gap size also minimizes problems associated with some samples' tendency to slip at the sensor walls due to poor adhesion. Corrections for end-effects are also needed unless minimized by using air gaps (see Figure 6.5) or else shaping the bob so as to yield shearing rates at the bottom that are similar to those in the gap. For dispersions, some advantages of concentric cylinder geometry over cone and plate geometry are that the constant size gap produces less likelihood of dispersed species bridging from one surface to the other and that the concentric cylinder arrangement is less affected by the normal forces produced by viscoelastic substances.

In the cone and plate rheometer, a cone-shaped bob is placed against a flat plate so that the fluid to be studied may be placed into the gap between the lower face of the cone and the upper face of the plate. Again, in the Searle method, the cone is rotated while in the Couette method the plate turns. In each case, the torque on the cone is measured. Figure 6.5 shows a Searle-type cone and plate arrangement. For this arrangement the shear stress is given by:

$$\tau = 3T/(2\pi R_c^3) \quad (6.21)$$

where  $R_c$  is the outer radius of the cone. The shear rate at the cone is given by:

$$\dot{\gamma} = \omega/(\tan \alpha) \quad (6.22)$$

where  $\alpha$  is the cone angle in degrees. For a cone turning at a speed of  $n$  revolutions per minute this equation becomes:

$$\dot{\gamma} \approx (n\pi/30\alpha) \quad (6.23)$$

Cone and plate sensor systems are useful when a constant shear rate across the gap is required, when sample sizes must be very small, and when sensor cleaning or sample recovery are problematic. They are less well suited to the study of suspensions of moderately-sized particles which may bridge the gap, causing erroneous readings, and cause wear to the cone and plate surfaces.

A range of rotational instruments are available which function like the concentric-cylinder rheometer described above. For example, the Fann viscometer, which is often used in the petroleum, environmental, and mineral processing industries, uses immersible concentric-cylinders (with modified geometry to alleviate the inevitable end-effects this introduces) and has eight selectable rotational speed settings. Bailey and Weir [364] discuss how to use such instruments to estimate the parameters in the common rheological models. Another example, the Thomas<sup>®</sup>–Stormer<sup>®</sup> viscometer, gravity drives a falling weight which in turn causes a certain number of revolutions of a cylinder immersed in a sample. The time required for a certain number of revolutions is measured. In this case, the shear rate is not held constant and the results, calculated in Krebs units, can only be converted into absolute viscosities if the sample fluids are known to be Newtonian. For Newtonian fluids, the conversion is given by:

$$\ln(KU) = a + b \ln(0.1938\eta + 36) - c [\ln(0.1938\eta + 36)]^2 \quad (6.24)$$

where  $KU$  is the viscosity in Krebs units,  $a$ ,  $b$  and  $c$  are empirical parameters, and  $\eta$  is viscosity in  $\text{mPa}\cdot\text{s}$ . Some values for  $a$ ,  $b$  and  $c$ , at 25 °C, are [358]:

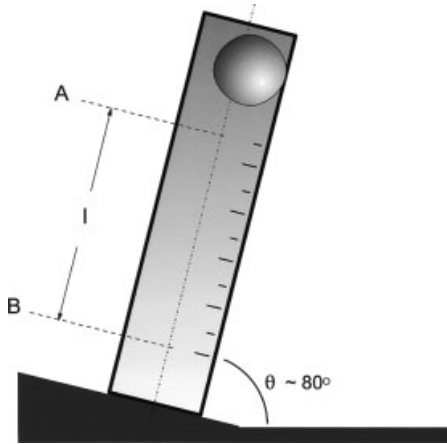
Viscosity range (mPa·s)	$a$	$b$	$c$
200–2100	1.1187	0.8542	0.0443
600–4300	1.348	0.762	0.035
2100–5000	1.8118	0.596	0.0206

### 6.2.3

#### Other methods

The falling ball (falling sphere or Höppler) viscometer consists of a solid sphere which can freely move within a transparent cylindrical measuring tube, usually placed at an angle of 10° to the vertical direction (see Figure 6.7). The apparatus is filled with fluid and the ball allowed to fall from the top of the inclined cylinder. The ball first accelerates to a steady velocity; one then measures the time required for the ball to fall between points such as those marked A and B in the figure. The time value is then converted to viscosity using calibration results obtained from the test-

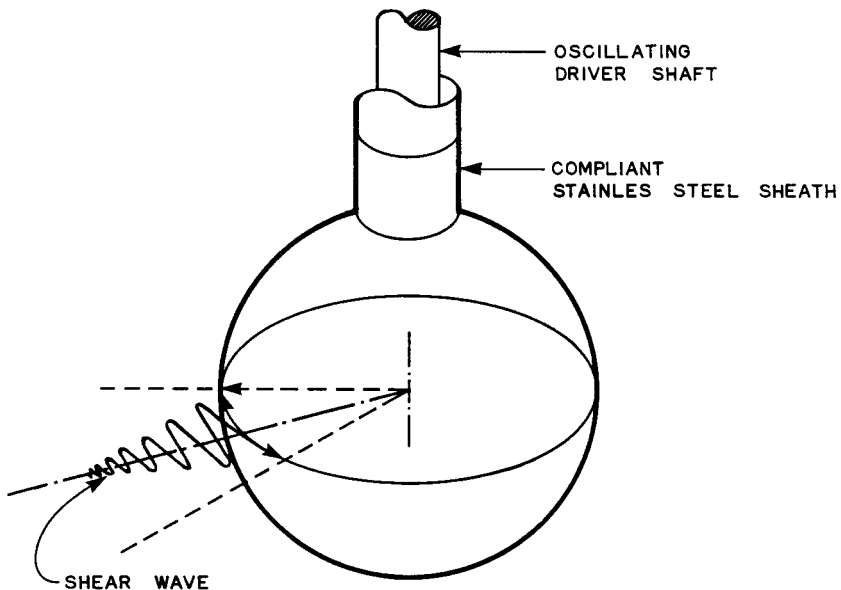




**Figure 6.7** Illustration of a falling ball viscometer.

ing of viscosity standard fluids. This apparatus is very easy to use but the test fluid must be transparent. The inset in Figure 6.7 shows how the gap size varies around the ball. Accordingly there is a significant range of shear rates and the technique is strictly applicable only to Newtonian fluids. A variation that can be used for non-Newtonian fluids is the falling needle viscometer. In this case a needle falls within a cylinder, so the shear rate is known. The rising bubble viscometer operates on the same principle except that the bubble naturally rises rather than falling.

An oscillation viscometer employs a vibrating surface in contact with a fluid of interest (Figure 6.8) [365]. If such a surface is made to vibrate at its natural fre-

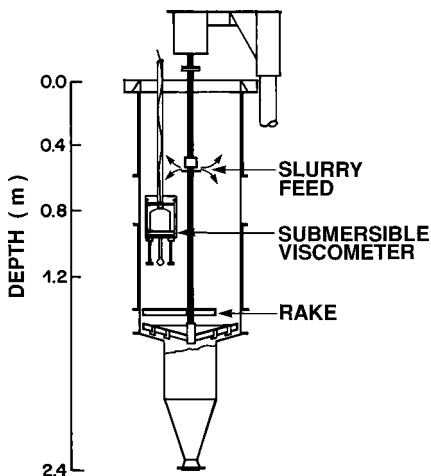


**Figure 6.8** An oscillation viscometer's vibrating surface in contact with a fluid. From reference [365]. Copyright 1972, Nametre Co.

quency then a continuous loss of amplitude of vibration occurs due to viscous drag. The power required to maintain a given amplitude, such as that experienced in air, gives a measure of the viscosity–density product of the test fluid [366,367]. Such instruments operate at high shear rates, about  $4000\text{ s}^{-1}$  [368] and, while strictly appropriate only for Newtonian fluids, can yield an estimate of high-shear viscosities. Since only a relatively inert torsional pendulum need be in contact with the fluid of interest such instruments are readily applied to measurements in pipes [369] and vessels [370]. Figure 6.9 shows a completely enclosed sensor immersed in a process vessel for *in situ* viscosity monitoring at various depths and under varying process conditions [92]. Such *in situ* measurements in process pipes or vessels have the advantage of yielding viscosity in the local process environment, which may include a particular state of dispersion of particles, droplets or bubbles at a given location, at a given point in time, and without the potential introduction of artifacts due to sampling.

Very much less useful are the various kinds of simplified measuring devices found in many industrial plants and even in their technical support laboratories. Such devices may not be capable of determining shear stresses for known shear rates or may not be capable of operation at shear rates that are appropriate to the process under consideration. Instruments that are capable of absolute viscosity measurements provide the most useful information.

There have now been attempts to determine rheological properties on the nano-scale. The nano-rheological properties (surface viscoelasticity) of emulsion droplets have been estimated through modelling based on data from atomic force microscope measurements [371].

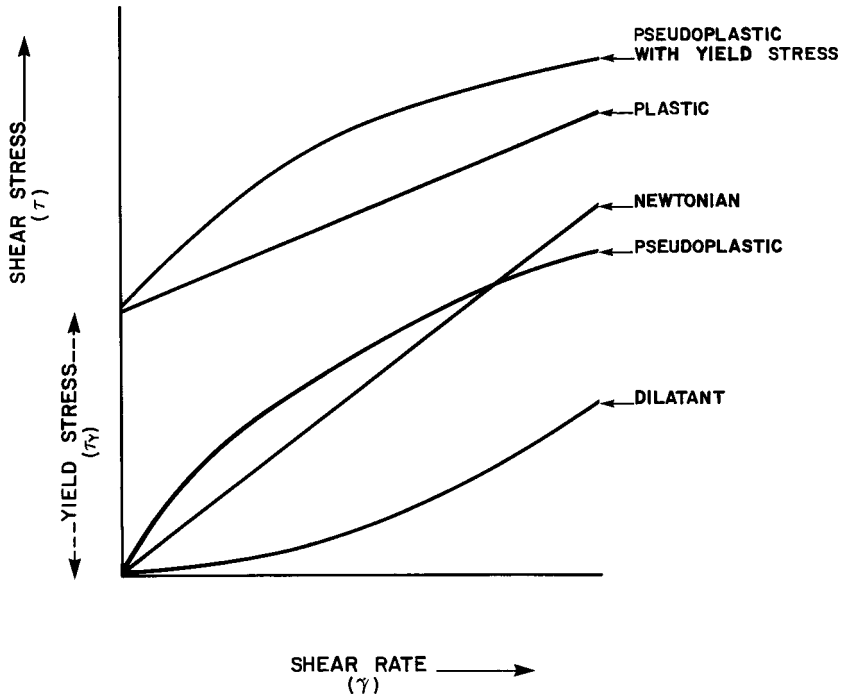


**Figure 6.9** A submersible oscillation viscometer for *in situ* viscosity measurements in a continuous process vessel. From Schramm [92]. Copyright 1989, The Petroleum Society.

## 6.3

## Non-Newtonian Flow Properties

As mentioned earlier, for non-Newtonian fluids the coefficient of viscosity is not a constant, but is itself a function of the shear rate. This leads to some very interesting flow properties. Some convenient ways to summarize the flow properties of fluids are by plotting curves (flow curves) of shear stress versus shear rate ( $\tau$  versus  $\dot{\gamma}$ ) as shown in Figure 6.10 [372], or by plotting viscosity versus shear rate as shown in Figure 6.11. These curves can be categorized into several rheological classifications, although it should be remembered that a colloidal system can exhibit several of the following characteristics at once.



**Figure 6.10** Typical flow curves of shear stress versus shear rate. From Schramm [372]. Copyright 1996, American Chemical Society.

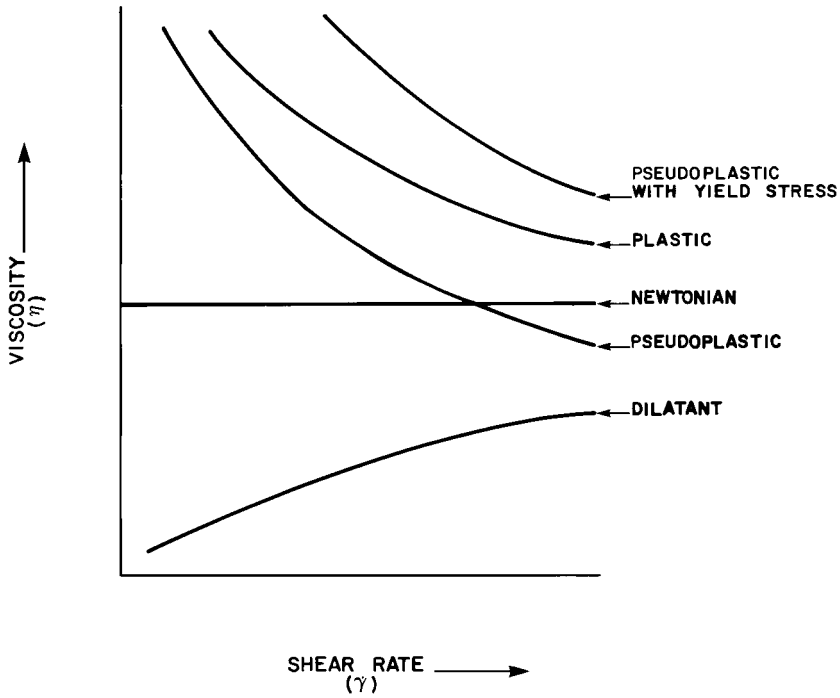


Figure 6.11 Typical curves of viscosity versus shear rate.

Some descriptions appropriate to different yield stresses and some approximate values of shear rate appropriate to various industrial processes are given in reference [373]. Some illustrations of dispersions at rest and under flow are given in Figure 6.12. Some examples are listed in Table 6.6.

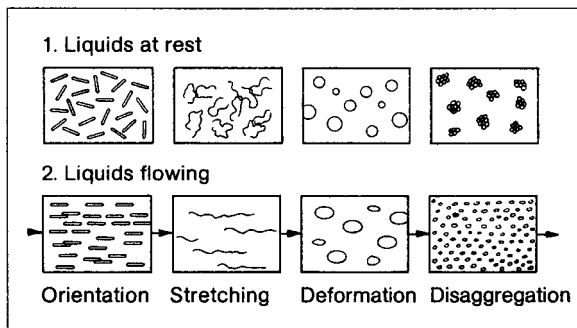


Figure 6.12 Illustrations of some dispersions at rest and under flow. From Schramm [349]. Copyright 1981, Gebrüder Haake GmbH.

**Table 6.6** Examples of dispersions exhibiting different rheological characteristics.

Rheological classification	Description	Examples
Pseudoplastic (shear-thinning)	As shear rate increases, viscosity decreases.	Paint, polymer solutions. In paint (a suspension of pigment particles in a liquid) irregular particles can align to match the induced flow, lowering the viscosity.
Dilatant (shear-thickening)	As shear rate increases, viscosity increases.	Wet beach sand, starch suspensions, PVC plastisols. In the “drying” of wet beach sand when walked on, a dense packing of particles occurs. Under low shear the particles can move past each other, whereas under high shear the particles wedge together such that the fluid cannot fill the increased void volume.
Pseudoplastic with yield stress (plastic)	Pseudoplastic or Newtonian flow begins only after a threshold shear stress, the yield stress, is exceeded.	Toothpaste, lipstick, grease, oil-well drilling mud. In oil-well drilling mud, the inter-particle network offers resistance to any positional changes. Flow only occurs when these forces are overcome.
Thixotropic	Time-dependent pseudoplastic flow. At constant applied shear rate, viscosity decreases. In a flow curve, hysteresis occurs.	Paint, quicksand. In bentonite clay “gels” which “liquefy” on shaking and “solidify” on standing, there is a time-dependent aligning to match the induced flow. After the shear rate is reduced it takes some time for the original alignments to be restored.
Rheoplectic	Time-dependent dilatant flow. At constant applied shear rate, viscosity increases. In a flow curve, hysteresis occurs.	Clay suspensions. A suspension which sets slowly on standing, but quickly when gently agitated due to time-dependent particle interference under flow.
Rheomalaxic	Time-dependent behaviour in which shear rate changes cause irreversible changes in viscosity.	Emulsions that invert when sheared irreversibly. An emulsion which, when sheared, inverts to a higher (or lower) viscosity emulsion, and does not re-invert when the shear is removed.

## 6.3.1

**Pseudoplasticity**

As shear rate increases, the viscosity of many colloidal dispersions decreases. Such systems are termed pseudoplastic, or shear-thinning. For such dispersions, the viscosity decreases the faster material is pumped through a pipe, sprayed out of a nozzle, or mixed with a mixer. As Figure 6.12 shows, pseudoplastic behaviour in dispersions can be caused by alignment, stretching, deformation, or peptization of dispersed material while being sheared. To refer to the viscosity of a non-Newtonian fluid or dispersion one must also cite the shear rate to which it applies. Table 6.2 gives some examples of some practical shear-rate ranges.

One of the most common empirical models used to describe the behaviour of pseudoplastic fluids is the the Ostwald–de Waele [374,375] model or, more colloquially, the power law model:

$$\tau = K \dot{\gamma}^n \quad (6.25)$$

where the exponent  $n$  is termed the flow behaviour index, or power law index) and  $K$  is termed the consistency factor. Notice that for a Newtonian fluid  $n=1$  and  $K$  is the Newtonian viscosity. For pseudoplastic fluids  $n < 1$ .

Better fits to the portions of the flow curve that are near  $\dot{\gamma} \rightarrow 0$  and  $\dot{\gamma} \rightarrow \infty$  are the Ellis (Eq. (6.26)) and Sisko (Eq. (6.27)) models, respectively:

$$\dot{\gamma} = -\tau \{ (1/\eta_0 + K_1 |\tau|^{\alpha-1}) \} \quad (6.26)$$

$$\tau = -\dot{\gamma} \{ \eta_\infty + K_2 |\dot{\gamma}|^{\delta-1} \} \quad (6.27)$$

where  $\eta_0$  is the viscosity at  $\dot{\gamma} \rightarrow 0$ ,  $\eta_\infty$  is the viscosity at  $\dot{\gamma} \rightarrow \infty$ ; and  $K_1$ ,  $K_2$ ,  $\alpha$ , and  $\delta$  are adjustable parameters. Both of Equations (6.26) and (6.27) have the power law, and Newton's law, as limiting forms.

The entire flow curve for pseudoplastic behaviour can often be fitted using the Reiner–Philippoff equation:

$$\tau = -\dot{\gamma} \{ \eta_\infty + [(\eta_0 - \eta_\infty)/(1 + (\tau^2/A))] \} \quad (6.28)$$

where  $A$  is an adjustable parameter. Other models are given elsewhere [364,376].

Examples of pseudoplastic fluids include many emulsions, foams, and suspensions. At very low shear rates, some pseudoplastic dispersions will behave like a Newtonian fluid because the Brownian motion of dispersed species counteracts the orienting effects of the applied shear. Above a certain shear rate, the shear effects then dominate and pseudoplastic flow is observed. In many dispersions exhibiting pseudoplastic flow the effect will be reversible, sometimes after some time lag (see thixotropy below).

## 6.3.2

**Dilatancy**

As the shear rate increases, the viscosity of some dispersions actually increases. This is called dilatancy, or shear-thickening. Dilatancy can be due to the dense packing of particles in very concentrated dispersions for which at low shear, the particles can just move past each other but at high shear they become wedged together such that the fluid cannot fill (lubricate) the increased void volume, and the viscosity increases. An example of this effect is the apparent “drying” of wet beach sand when walked on, the sand in the footprint initially appears very dry and then moistens a few seconds later. Other examples include concentrated suspensions (plastisols) of polyvinyl chloride (PVC) particles in plasticizer liquid and the commercial novelty product Silly Putty® (which is a silicone material).

## 6.3.3

**Plasticity/Pseudoplasticity with Yield Stress**

In some colloidal dispersions, the shear rate (flow) remains at zero until a threshold shear stress is reached, termed the yield stress ( $\tau_Y$ ), and then Newtonian or pseudo-plastic flow begins. A common cause of such behaviour is the existence of an inter-particle or intermolecular network which initially acts like a solid and offers resistance to any positional changes of the volume elements. In this case flow only occurs when the applied stress exceeds the strength of the network and what was a solid becomes instead a fluid.

Examples include oil-well drilling muds, greases, lipstick, toothpaste, and natural rubber polymers. An illustration is provided in Figure 6.13. Here, the flocculated structures are responsible for the existence of a yield stress. Once disrupted, the nature of the floc break-up process determines the extent of shear thinning behaviour as the shear rate increases.

Two of the most common empirical models used to describe the behaviour of pseudoplastic fluids with yield stresses are the Bingham plastic [377] model:

$$\tau = \tau_o + \eta_p \dot{\gamma} \quad (6.29)$$

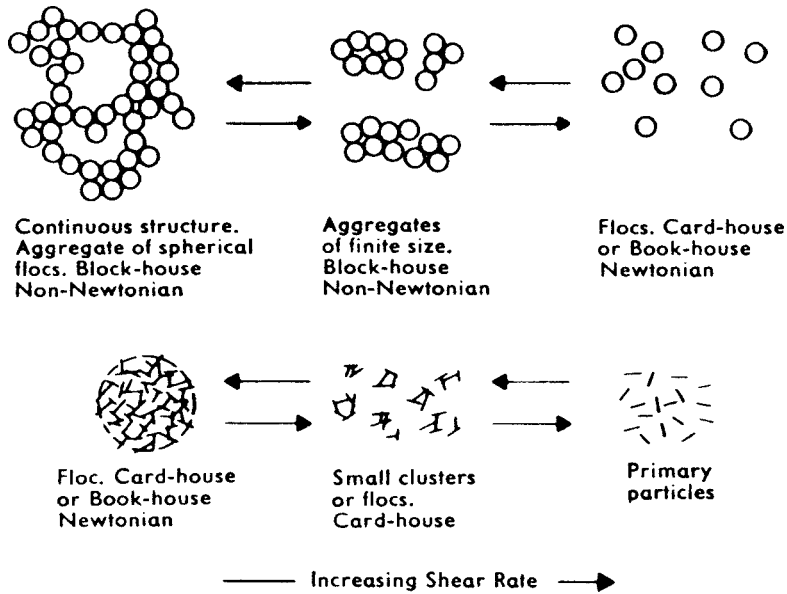
where  $\tau_o$  is the yield stress and  $\eta_p$  is the Bingham plastic viscosity, and the Herschel–Bulkley [378] model:

$$\tau = \tau_o + K \dot{\gamma}^n \quad (6.30)$$

Comparison with Eq. (6.24) shows that the Herschel–Bulkley model is the power-law model with the addition of a yield stress. Another such derivative model is the Robertson–Stiff [379] model:

$$\tau = K(C_o + \dot{\gamma})^n \quad (6.31)$$

where  $C_o$  is a constant. Other models are given elsewhere [364,376,380].



**Figure 6.13** Schematic representation of the disruption of structure of flocculated particles accompanying an increase in flow rate. From Yariv and Cross [49]. Copyright 1979, Springer-Verlag: Berlin.

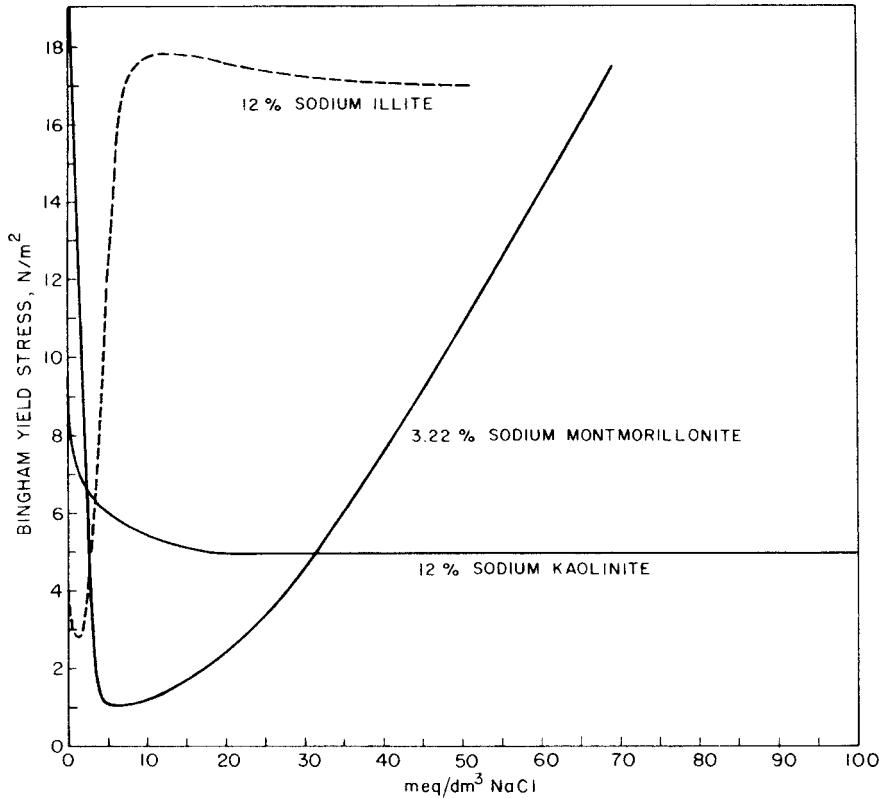
Some examples of dispersions that are formulated to have yield stresses, include oil-well drilling muds, toothpaste and lipstick. The yield stresses can vary considerably in magnitude; Table 6.7 provides some descriptions appropriate to different yield stresses. As an example, Figure 6.14 shows how the yield stress in clay suspensions can change with varying electrolyte concentration. In this case the variations result from the influence of indifferent electrolyte on different electric double layers (those present at particle faces and edges), and the consequent effects on particle associations in the dispersion (face–face, edge–face, and edge–edge, see Section 5.6.2).

**Table 6.7** Some descriptions appropriate to different yield stresses.

Yield stress (Pa·s)	Description
< 10	Easy to pour, like milk.
10–20	Thick, pours easily, like thin milk-shake. Use conventional liquid designs.
30–40	Thick, hard to pour, forms peaks, can write on surface. Difficult to make flow under pump suction.
40–100	Flows poorly, will cleave to walls under gravity. Need to push into pump suction.
> 100	Can build with it, will cleave to top of jar. Requires positive flow pump.

Source: Ref. [373].





**Figure 6.14** Bingham yield stress of clay gels as a function of the amount of NaCl added. From van Olphen [1]. Copyright 1977, Wiley-Interscience.

#### 6.3.4

#### Thixotropy

Thixotropy refers to pseudoplastic flow that is time dependent. At a constant applied shear rate, the viscosity decreases, as shown in Figure 6.15. In a flow curve, hysteresis occurs; here the interparticle or intermolecular alignments are not only influenced by the magnitude of the applied shear but also by the time interval over which the shear is applied. Thixotropy arises because, after the shear is applied, it takes some time for the interparticle or intermolecular alignments to be altered, and after the shear rate is reduced it takes some time for the original alignments to be restored. If the sheared system is allowed to stand it will eventually regain its original structure. Lipstick must be pseudoplastic and thixotropic so that it will flow when applied and immediately after application (for a smooth finish) but then quickly regain a high (semi-solid) effective viscosity so that it will not sag or run. Other examples are found in ceramics, foods, cosmetics, and pharmaceuticals.

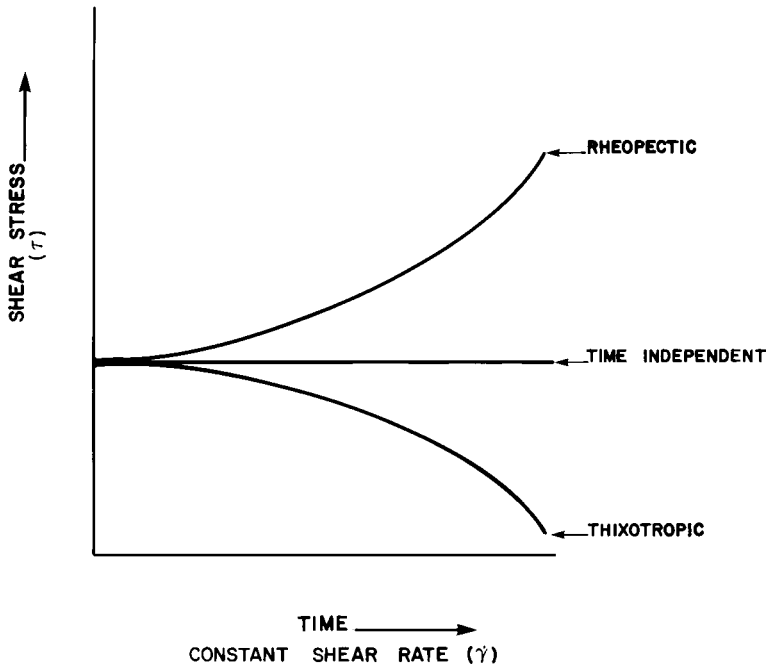


Figure 6.15 Illustration of time-dependent types of rheological behaviour.

**Example.** A colloidal system can exhibit several of these characteristics at once. For example, paint must be plastic and thixotropic so that it will flow when brushed on and (only) immediately after brushing (for a smooth finish); a further benefit is that vigorous mixing readily disperses the pigments which then stay dispersed for some time when standing (high yield stress). Finally, shortly after brushing-on, the paint should cease to flow so that it doesn't "run".

### 6.3.5

#### Rheopexy

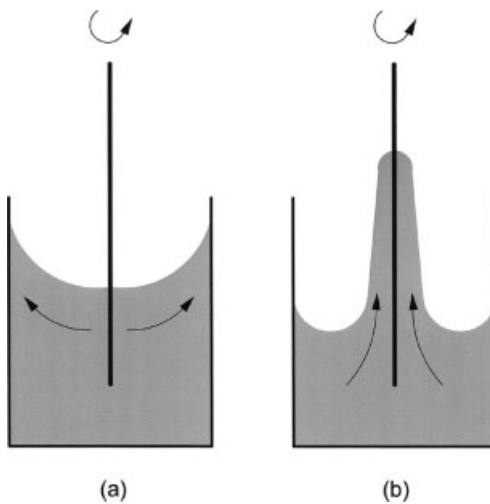
Rheopexy refers to dilatant flow which is time dependent. At a constant applied shear rate viscosity increases, as shown in Figure 6.15. In a flow curve, hysteresis occurs (but opposite to the thixotropic case). An example of a rheopectic system is a bentonite clay "gel" system which sets slowly on standing, but sets quickly when gently agitated.

## 6.3.6

**Viscoelasticity**

Viscoelastic fluids have elastic properties in addition to their viscous properties. When under shear, such fluids exhibit a normal stress in addition to a shear stress. For example, if a vertical rod is partly immersed and rotated in a non-viscoelastic liquid the rod's rotation will create a centrifugal force that drives liquid outwards toward the container walls, as shown in Figure 6.16(a). If, on the other hand, the liquid is viscoelastic then as the liquid is sheared about the rod's axis of rotation, a stress normal to the plane of rotation is created which tends to draw fluid in towards the centre. At some rotational speed, the normal force will exceed the centrifugal force and liquid is drawn towards and up along the rod; see Figure 6.16(b). This is called the Weissenberg effect. Viscoelastic fluids flow when stress is applied, but some of their deformation is recovered when the stress is removed [381].

Concentrated emulsions can exhibit viscoelasticity, as can gelled foams and some suspensions. Compared with the previous equations presented, additional coefficients (including primary and secondary normal stress coefficients) are needed to characterize the rheology of viscoelastic fluids [376,382].



**Figure 6.16** The centrifugal effect in a non-elastic liquid (a), and the Weissenberg effect in a viscoelastic liquid (b).

## 6.3.7

**Rheomalaxis**

Rheomalaxis is a special case of time-dependent behaviour in which the shear rate changes cause irreversible changes in viscosity. The change can be negative, as when structural linkages are broken, or positive, as when structural elements become entangled (like work-hardening). Example: An emulsion which when

sheared inverts to a higher (or lower) viscosity emulsion, and does not re-invert when the shear is removed.

### 6.3.8

#### Summary

The categorizations just presented are helpful in describing the rheological properties of many emulsions, foams, and suspensions. It should be remembered, however, that some dispersions are not well described by any single category. Some dispersions exhibit Newtonian behaviour at low shear rates, shear thinning at moderate shear rates, Newtonian at still higher, and shear thickening at yet higher shear rates, all as a result of different structure-forming tendencies in different shear regimes, on the part of the dispersed species [376,382]. As discussed in Section 7.1.1, emulsions can invert under high shear, which provides an additional change in rheological behaviour.

## 6.4

### Other Viscosity Nomenclature and Parameters

#### 6.4.1

#### Viscosity Nomenclature

There are numerous ways in which viscosities are expressed in the literature. Some of the most common are defined Table 6.8. There is an entire lexicon of terms used to describe the different rheological classifications of colloidal dispersions [9–11,353,355].

**Table 6.8** Bulk viscosity terms.

Term	Symbol	Explanation
Absolute viscosity	$\eta$	$\eta = \tau / \dot{\gamma}$ and can be traced to fundamental units independent of the type of instrument.
Apparent viscosity	$\eta_{APP}$	$\eta_{APP} = \tau / \dot{\gamma}$ but as determined for a non-Newtonian fluid, usually by a method suitable only for Newtonian fluids.
Differential viscosity	$\eta_D$	$\eta_D = d \tau / d \dot{\gamma}$
Inherent viscosity	$\eta_{Inh}$	$\eta_{Inh} = C^{-1} \ln(\eta/\eta_o)$
Intrinsic viscosity	$[\eta]$	$[\eta] = \lim_{c \rightarrow 0} \lim_{\dot{\gamma} \rightarrow 0} \eta_{SP} / C = \lim_{c \rightarrow 0} \lim_{\dot{\gamma} \rightarrow 0} (1/C) \ln \eta_{Rel}$
Kinematic viscosity	$\nu$	$\nu = \eta / \rho$
Reduced viscosity	$\eta_{Red}$	$\eta_{Red} = \eta_{SP} / C$
Relative viscosity	$\eta_{Rel}$	$\eta_{Rel} = \eta / \eta_o$
Specific increase in viscosity	$\eta_{SP}$	$\eta_{SP} = \eta_{Rel} - 1$

$\eta_o$  = viscosity of the pure solvent or dispersion medium).

C = dispersed phase concentration (usually volume fraction).

## 6.4.2

**Other Viscosity Parameters**

In general, the viscosity will be a function of the physical-chemical nature of the dispersion or substance, its temperature (usually  $\eta$  drops as T increases), its pressure (usually increasing P compresses and increases the intermolecular resistance, increasing  $\eta$ ), the applied shear rate (as seen above this can either increase or decrease viscosity), and time (for many dispersions their recent history influences the present viscosity). An important consequence is that if one wishes to determine viscosity as a function of one of these parameters then the other four must be kept well defined (usually constant).

**Example.** Suppose five different water-in-oil emulsions have to be tested for viscosity comparison. One might keep the sample temperatures maintained to  $\pm 0.1^\circ\text{C}$  (using jacketed sensors). If the emulsion production and application are both at ambient pressure then testing should be under the same condition (open sensors). Assuming that the emulsions are non-Newtonian, viscosity will be a strong function of  $\dot{\gamma}$ ; one should compare measurements made at the same fixed shear rate (minimum requirement), or (preferably) compare complete flow curves. These samples are likely to be thixotropic so the tests should follow a reproducible schedule (e.g., measuring always after high (specified) shearing, always after 5 or 10 min. of (specified) shearing, or always after 1 or 7 days of standing (following a specified means of shearing).

It was just stated that the viscosity of liquids and dispersions usually decreases as temperature increases. An exception is the case of gases whose viscosities usually increase slightly with temperature, with a temperature coefficient of about 0.3% per degree Kelvin [383]. The viscosities of liquids usually decrease with increasing temperature, and more strongly. A number of equations, of varying degrees of complexity, have been formulated to enable one to empirically predict liquid viscosities as a function of temperature [384–386]. A simple, often used, relation is the Andrade equation,

$$\eta = A \exp (b/T) \quad (6.32)$$

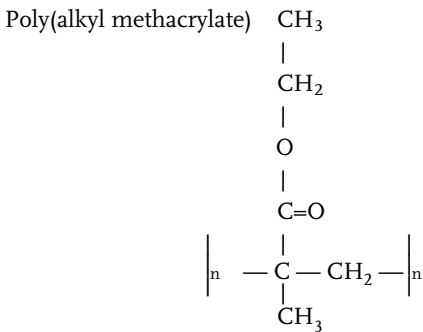
where A and b are empirical constants. This equation has been used to describe the behaviour of even very viscous liquids, suspensions and emulsions containing such as bitumen, and bituminous froths [387].

In the petroleum industry a dimensionless number termed the viscosity index has been used to describe the temperature dependence of a fluid's kinematic viscosity. The calculation of viscosity index involves the use of published look-up tables [388]. In terms of relative changes, a higher viscosity index represents a smaller decrease in viscosity with increasing temperature.

**Example: Multigrade lubricating oils.** The viscosity grading of some automotive engine oils is shown in the table below [389].

SAE viscosity grade	Maximum absolute viscosity at $-18^{\circ}\text{C}$ , mPa·s	Minimum kinematic viscosity at $+100^{\circ}\text{C}$ , $\text{mm}^2/\text{s}$	Maximum kinematic viscosity at $+100^{\circ}\text{C}$ , $\text{mm}^2/\text{s}$
5W	1250	3.8	
10W	2500	4.1	
20W	10 000	5.6	
20		5.6	< 9.3
30		9.3	<12.5
40		12.5	<16.3
50		16.3	<21.9

It is frequently desirable to use oils that meet the requirements of more than one grade, e.g., 10W–50. This can be achieved by adding viscosity-index improvers to a base oil. These are typically linear polymers such as poly(alkyl methacrylate) (MW 45 000–1 700 000). Thus, a few percent addition of poly(alkyl methacrylate) can make a light oil such as 10W more viscous to meet the 10W–50 specification, without making its viscosity much more temperature dependent. This is an advantage since heavier oils are generally more temperature sensitive than light oils. At low temperatures the polymer adopts a compact, curled configuration and has little effect on the base oil viscosity. At higher temperatures the molecules uncurl and begin to adopt stretched-out (higher surface area) configurations which increasingly interact with each other, increasing the viscosity of the oil above that of the base oil at the same temperatures. This selective thickening allows the viscosity to remain in a useful viscosity range over a much broader range of temperatures.



The viscosities of liquids usually increase with increasing pressure. For many oils the increase with pressure is exponential [383].

## 6.4.3

**Experimental Considerations**

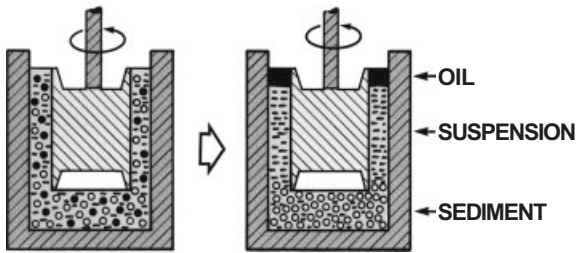
To apply Newton's Law (Eq. (6.4)) test conditions must approximate the assumptions made in evaluating Newton's Law and the Equation of Motion:

- Applied shear must produce laminar flow (homogeneous sample, no mixing). In some measuring systems Newtonian samples such water sometimes appear to be dilatant at very high shear rates due to the additional energy requirements of increasing turbulence.
- Steady-state flow is required (enough time to reduce initial acceleration to zero).
- "No-slip" is assumed (care is needed for some dispersions such emulsions and foams).
- Samples are assumed homogeneous (in dispersions the size of the dispersed species must be much smaller than the thickness of the shear layers; laminar flow will not mix a sample; cannot allow for phase separation).
- Samples are assumed stable (shear-induced structural changes may or may not be part of the study; decomposition, evaporation, etc., not allowed).
- If the samples are non-Newtonian then measurements should be made over the same range of shear rates that they would encounter in the application of interest.

In attempting to conduct rheological measurements on dispersions a number of changes, such as phase separation, may occur in the sample chamber making the measurements irreproducible and not representative of the original dispersion [390]. For suspensions, prevalent among these changes is the sedimentation, or even centrifugal segregation of solids causing a non-uniform distribution within the measuring chamber. In the extreme sedimentation can cause complete removal of solids from the region in which measurements are made. One reason for the relative lack of rheological data for emulsions and foams, compared with that for other colloidal systems such as suspensions, is the difficulty associated with performing the measurements in these systems. Such changes (see Figure 6.17) may include the following.

- Creaming of droplets or bubbles, causing a non-uniform distribution within the measuring chamber, or even removal of all droplets/bubbles into an upper layer away from the region in which measurements are made.
- Centrifugal separation of gas, oil, water and solid phases, making the dispersion radially inhomogeneous, and possibly breaking emulsions or collapsing foams.
- Loss of volatile solvent from a dispersion, causing the dispersed phase concentration to increase.
- Shear-induced coalescence or finer dispersion of droplets or bubbles, changing the properties of the sample.

## RHEOLOGICAL MEASUREMENT PROBLEMS IN MULTI-PHASE SYSTEMS



**Figure 6.17** Some of the phase separations that may occur during rheological measurements involving colloidal dispersions. The sample shown contains oil droplets (●), coarse solids (○), and fine solids (-). From Schramm [95]. Copyright 1992, American Chemical Society.

- Sedimentation of solids (or other dense phase), causing a non-uniform distribution within the measuring chamber, or even removal of one phase into a lower layer away from the region in which measurements are made.

Careful observations may be needed to identify the occurrence of these phenomena. Some strategies that may be helpful include conducting repeated measurements on individual samples versus repeated measurements on independent aliquots of original dispersion, and generating families of flow curves using different rates of change of shear rate. Many of the above problems can be minimized by always employing the minimum possible measuring system gap. Instrument manufacturers market a number of profiled concentric cylinder rotors intended to counteract the processes of creaming and sedimenting, but which make the assessment of effective shear rate(s) more difficult.

With due care, many of the above described techniques may be applied to emulsions, foams, and suspensions. For example, measurements may be made with a foam or froth sample placed in the annulus between two concentric cylinders [43,98].

## 6.5 Dispersion Rheology

### 6.5.1 Einstein's Equation

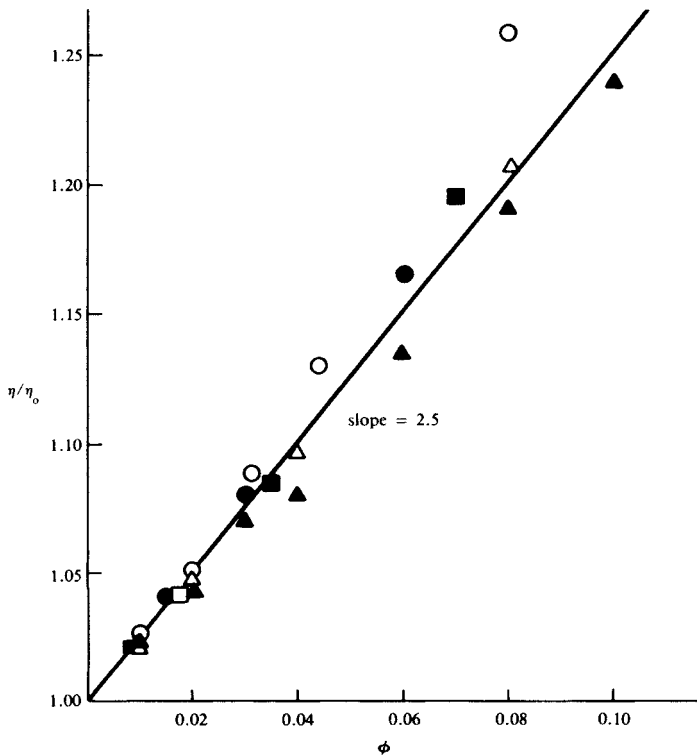
It is frequently desirable to be able to describe and/or predict dispersion viscosity in terms of the viscosity of the continuous phase ( $\eta_0$ ) and the amount of dispersed material. A very large number of equations have been advanced for estimating emul-



sion, or foam, or suspension viscosities. Most of these are empirical extensions of Einstein's equation for a dilute suspension of non-interacting spheres:

$$\eta = \eta_0 (1 + 2.5\phi) \quad (6.33)$$

where  $\eta_0$  = medium viscosity and  $\phi$  = dispersed phase volume fraction (with a requirement that  $\phi < 1$ ). This equation usually applies best when  $\phi < 0.02$ . Figure 6.18 shows several sets of experimental data compared with the Einstein equation. In practice, once  $\phi$  reaches between 0.1 and 0.5, the dispersion viscosity increases significantly and can also become non-Newtonian (due to particle/droplet/bubble "crowding," or structural viscosity). The maximum volume fraction possible for an internal phase made up of uniform, incompressible spheres is 0.74, although emulsions and foams with an internal volume fraction of over 0.99 can exist as a consequence of droplet/bubble distortion. Figure 6.18 and Eq. (6.33) illustrate why vol-



**Figure 6.18** Comparison of several sets of experimental data and the Einstein equation. From Hiemenz [87]. Copyright 1986, Dekker.

ume fraction is such a theoretically and experimentally favoured concentration unit in rheology. In the simplest case a colloidal system can be considered Einsteinian, but in most cases the viscosity dependence is more complicated.

Note from Table 6.8 that the reduced viscosity gives the relative increase in the viscosity of the solution over the solvent, per unit of concentration. Since  $[\eta]$  is the limiting value of the reduced viscosity, it is a measure of the first increment of viscosity due to the dispersed particles and is therefore characteristic of the particles. Equation (6.33) predicts that the intrinsic viscosity should equal 2.5 for spherical particles. If the dispersed phase volume fraction is used to reflect the dry-weight concentration of particles that may become solvated when dispersed, then intrinsic viscosity measurements can be used to determine the extent of solvation as follows. Suppose the mass of colloidal solute in a solution is converted to the volume of unsolvated material using the “dry” density. If the particles are assumed to be uniformly solvated throughout the dispersion then the solvated particle volume exceeds that of the unsolvated particle volume by the factor  $1 + (m_{1,b}/m_2)(\rho_2/\rho_1)$ ; where  $m_{1,b}$  is the mass of bound solvent,  $m_2$  is the mass of the solute particle,  $\rho_2$  is the density of the particle and  $\rho_1$  is the density of the solvent. Since  $\phi_{\text{dry}}$  has been used to evaluate  $[\eta]$ , we get:

$$(1/\phi_{\text{dry}})(\eta/\eta_0 - 1) = 2.5\{1 + [(m_{1,b}/m_2)(\rho_2/\rho_1)]\} \quad (6.34)$$

Another equation for concentrated suspensions is that of Brinkman [391] (sometimes also attributed to Roscoe [392]):

$$\eta = \eta_0(1 - \phi)^{-2.5} \quad (6.35)$$

Equation (6.35) reduces to the Einstein Equation (6.33) when  $\phi \rightarrow 0$ .

Other modifications have been made for application to suspensions of anisometric particles such as clays. In this case the intrinsic viscosity  $[\eta]$ , given by:

$$[\eta] = \lim_{\phi \rightarrow 0} \lim_{\dot{\gamma} \rightarrow 0} (\eta/\eta_0 - 1) / \phi \quad (6.36)$$

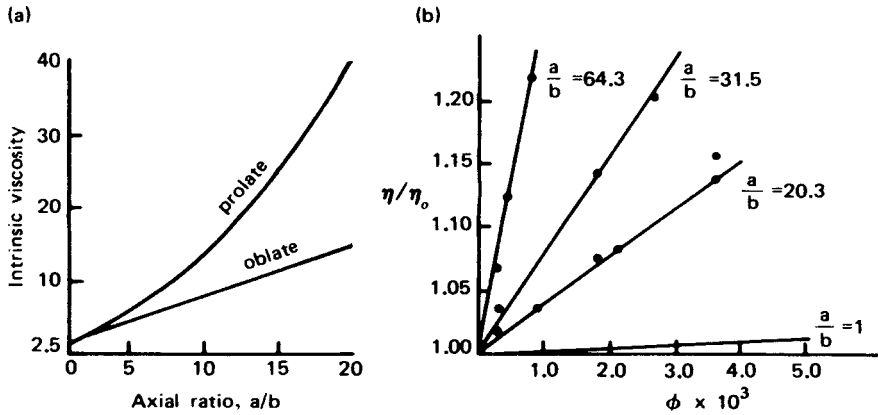
which equals 2.5 for a dilute suspension of uncharged spheres, takes on a different and more difficult to predict value. A useful such modification to Einstein’s equation for dilute suspensions of anisotropic particles, such as clay suspensions, is given by the Simha Equation, which is:

$$\eta = \eta_0(1 + 32\phi/\{15p\pi\}) \quad (6.37)$$

where  $p$  is the ratio of particle thickness to particle diameter (and must be small). This equation is sometimes cited in its approximate form as:

$$\eta = \eta_0(1 + a\phi/1.47b) \quad (6.38)$$

where  $a$  is the major particle dimension and  $b$  the minor particle dimension (i.e.,  $p=b/a$ ). See Figure 6.19 for illustrations.



**Figure 6.19** Experimental variation of relative viscosity with volume fraction for particles having different  $a/b$  ratios. From Hiemenz [87]. Copyright 1986, Dekker.

**Example.** A tailings stream from the hot-water flotation process (oil sands) contains 27 % (mass) solids. Estimate the suspension viscosity. Light-scattering analysis indicates that the particles are finely divided and anisotropic with a  $10 \mu\text{m}$  major dimension and a  $0.5 \mu\text{m}$  minor dimension. Using Eq. (6.38):

$$\phi = (27\text{g} / 2.54\text{g/mL}) / \{(73\text{g} / 1.0\text{g/mL}) + (27\text{g} / 2.54\text{g/mL})\} = 0.127$$

$$\eta = (1.0\text{mPa}\cdot\text{s}) \{1 + (10 \cdot 0.127) / (1.47 \cdot 0.5)\} = 2.7\text{mPa}\cdot\text{s}$$

Actual *in situ* process viscosity measurements (see Figure 6.9) yield values of 7–10  $\text{mPa}\cdot\text{s}$  for this concentration, depending upon solution pH (see Figure 6.20). Why are they higher than the equation predicts?

### 6.5.2

#### Virial Expansions

Many of the other viscosity equations are simply empirical virial expansions, and typically have the form [37,215]:

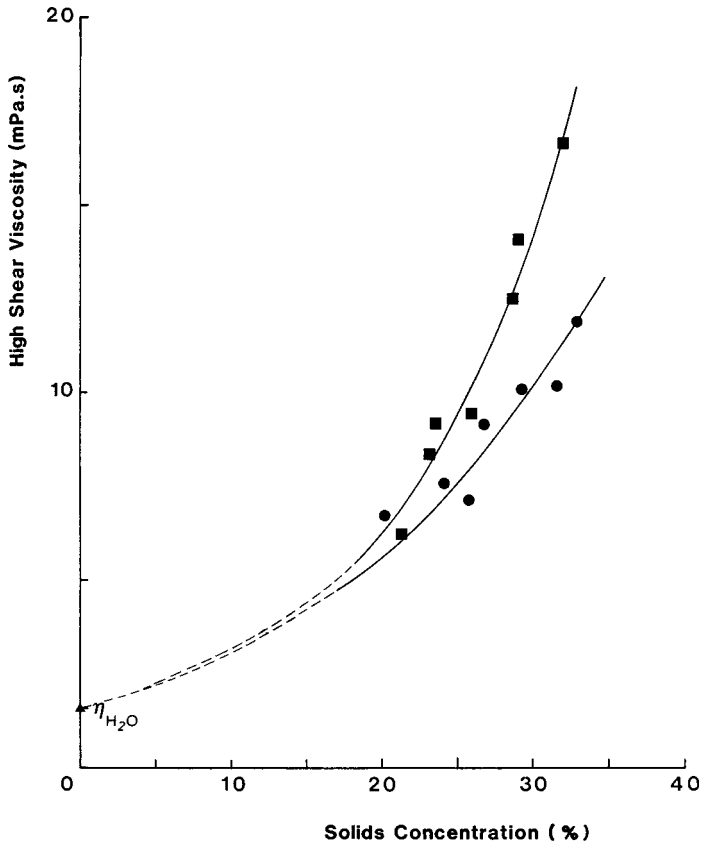
$$\eta = \eta_0 (1 + a_0\phi + a_1\phi^2 + a_2\phi^3 + \dots) \quad (6.39)$$

such as the Guth–Gold–Simha equation ( $\phi < 0.06$ ), which has a  $\phi^2$  term:

$$\eta = \eta_0 (1 + 2.5\phi + 14.1\phi^2) \quad (6.40)$$

and such as the Oliver–Ward equation for spheres [10], which has higher terms:

$$\eta = \eta_0 (1 + a\phi + a^2\phi^2 + a^3\phi^3 + \dots) \quad (6.41)$$



**Figure 6.20** Variation of high shear viscosity with particle concentration for tailings pond slurries at pH 6 (■) and 8 (●). From Schramm [92]. Copyright 1989, The Petroleum Society.

where  $a$  is an empirical constant. Similar equations may include other terms, as in the Thomas equation [215] for suspensions,

$\eta = \eta_0 (1 + a\phi + b\phi^2 + c\phi^3 + \dots + A_T \exp[B_T\phi])$ , one form of which is:

$$\eta = \eta_0 (1 + 2.5\phi + 10.5\phi^2 + 0.00273 \exp[16.6\phi]) \quad (6.42)$$

Where  $a$ ,  $b$ ,  $c$ ,  $A_T$  and  $B_T$  are constants. Values for the constants in the more general form of the Thomas equation are tabulated in Ref. [215].

## 6.5.3

**Other Empirical Equations**

Still other equations for concentrated suspensions depart from the above forms. There are a number of variations on the Mooney equation [393],

$$\eta = \eta_0 \exp(2.5\phi/\{1 - a\phi\}) \quad (6.43)$$

(where  $a$  is an empirical constant), including that of Krieger and Dougherty [394],

$$\eta = \eta_0 (1 - \phi/\phi_{\max})^{-2.5\phi_{\max}} \quad (6.44)$$

where  $\phi_{\max}$  is the maximum packing fraction. For non-spherical particles the intrinsic viscosity can be substituted for the factor 2.5 in Eq. (6.44) [93].

A comparison of some of these models with a range of experimental results is given by Liu and Masliyah [376]. These equations (6.43 and 6.44) and other, similar relations, have also been used to describe the viscosity of both suspensions and emulsions [376,382].

The above equations assume Newtonian behaviour, or at least apply to the Newtonian region of a flow curve, and they usually apply if the dispersed species are not too large, and if there are no strong electrostatic interactions. Any of emulsions, foams, or suspensions can show more strongly varying rheological, or viscosity, behaviours and may not be well described by any of these equations. Sometimes these properties are due to stabilizing agents in the dispersion. However, typically droplet–droplet, bubble–bubble, or particle–particle interactions alone are sufficient to cause the suspension viscosity to increase due to electrostatic interactions, or simply particle “crowding.” The rheological properties also depend on any specific interactions among the colloidal species, the dispersing medium, and the solute additives, i.e., salts, surfactants, and polymers. Additional equations are tabulated elsewhere [10,37]. More detailed treatment of these relationships is given elsewhere for emulsions [37,360,382], foams [46,301], and suspensions [1,376].

## 6.5.4

**Dispersed Phase Size and Polydispersity**

Thus far most of the relationships discussed apply to monodisperse systems in which the dispersed species have the same size and shape. Although for a monodisperse system, relative viscosity is often independent of droplet/bubble/particle size, at the high end of the dispersed phase volume fraction range the viscosity will often become influenced by size. The actual range of volume fraction for which this occurs depends strongly on the nature of a particular system, including factors such as surface rigidity [215].

For a polydisperse system, the size distribution tends to have an important influence on viscosity regardless of the volume fraction concerned. For a given volume fraction of dispersed species, having a size distribution tends to reduce the hydrody-

dynamic resistance to flow. Generally, viscosity decreases and the maximum achievable dispersed phase volume fraction increases. For dispersions that are essentially bi-modal, a common approach to estimating the relative viscosity involves calculating the product of the relative viscosity for each component, as determined for each by an empirical equation such as the Krieger–Dougherty equation. This works best when both the concentration and sizes of each kind of dispersed species are very different from each other. Additional details are available elsewhere [9,215,376].

### 6.5.5

#### Additional Considerations for Emulsions and Foams

Some equations have been developed specifically for emulsions. Some are variations on Einstein's equation, such as that developed by Taylor [395]:

$$\eta = \eta_0 (1 + 2.5\phi[(\eta_2/\eta_1) + 0.4] + ((\eta_2/\eta_1) + 1)) \quad (6.45)$$

where  $\eta_2/\eta_1$  is the ratio of the dispersed ( $\eta_2$ ) to continuous ( $\eta_1$ ) phase viscosities. Other starting points are often the Richardson equation [396],

$$\eta = \eta_0 \exp(a\phi) \quad (6.46)$$

or the Broughton–Squires equation [397],

$$\eta = \eta_0 \exp(a_1\phi + a_2) \quad (6.47)$$

where  $a$  and  $a_i$  are empirical constants. For concentrated emulsions ( $\phi > 0.5$ ) there is the Hatschek equation [398],

$$\eta = \eta_0(1/\{1 - \phi^{1/3}\}) \quad (6.48)$$

and a later variation, the Sibree equation [399],

$$\eta = \eta_0(1/\{1 - (a\phi)^{1/3}\}) \quad (6.49)$$

For polydisperse, possibly non-Newtonian emulsions, Eilers [400] developed,

$$\eta = \eta_0(1 + [12.5\phi/(1 - a\phi)])^2 \quad (6.50)$$

where in this case  $a = 1.35$  for uniform spheres, and otherwise ranges from 1.28 to 1.30.

Pal and Rhodes [401] developed,

$$\eta = \eta_0(1 + [(\phi/\phi^*)/(1.187 - (\phi/\phi^*))])^{2.49} \quad (6.51)$$

where  $\phi^*$  is the dispersed phase volume fraction for which the relative viscosity becomes 100. Equation (6.51) was developed for both Newtonian and non-Newtonian

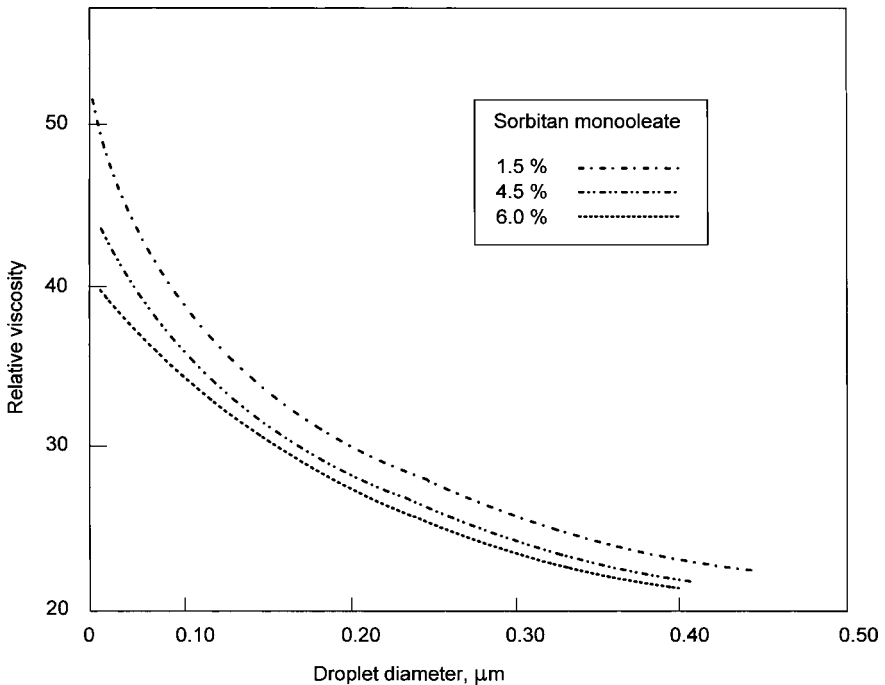
nian emulsions. Pal's work has been adapted to higher concentrations by Krynke and Sęk [402].

For electrostatically or sterically interacting drops, emulsion viscosity will be higher when droplets are smaller. The viscosity will also be higher when the droplet sizes are relatively homogeneous, that is, when the drop size distribution is narrow rather than wide. The nature of the emulsifier can influence not just emulsion stability but also the size distribution, mean droplet size, and therefore the viscosity. To describe the effect of emulsifiers on emulsion viscosity Sherman [215] has suggested a modification of the Richardson Equation to the following form:

$$\eta = \eta_o \exp(K_S C_E \phi + Y_S) \quad (6.52)$$

where  $C_E$  is the concentration of the emulsifier and  $K_S$  and  $Y_S$  are constants. Figure 6.21 shows an example of the effect of the emulsifier on viscosity.

If the internal phase in an emulsion has a sufficiently high volume fraction (typically anywhere from 10 to 50%) the emulsion viscosity increases due to droplet "crowding," or structural viscosity, and becomes non-Newtonian. The maximum volume fraction possible for an internal phase made up of uniform, incompressible spheres is 74%, although emulsions with an internal volume fraction of 99% have

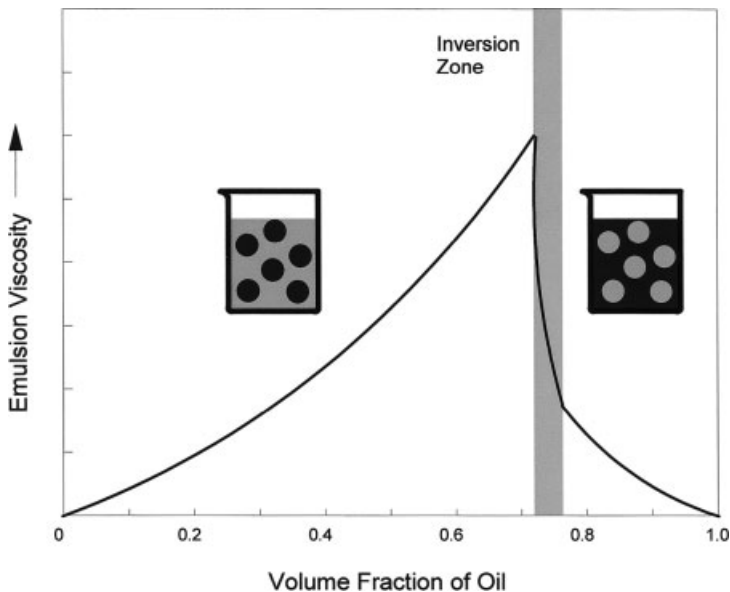


**Figure 6.21** The influence of emulsifier concentration on the relative viscosity of sorbitan mono-oleate stabilised W/O emulsions in paraffin. The emulsions had dispersed phase volume fractions in the range 0.37 to 0.68 and mean droplet diameters,  $a_m$ , as plotted along the x-axis. From data in Sherman [215].

been made [96]. Figure 6.22 shows how emulsion viscosity tends to vary with volume fraction; the drop in viscosity at  $\phi = 0.74$  signifies inversion. At this point the dispersed phase volume fraction becomes 0.26, in this example, and the lower value of  $\phi$  is reflected by a much lower viscosity. If inversion does not occur, then the viscosity continues to increase. This is true for both W/O and O/W types.

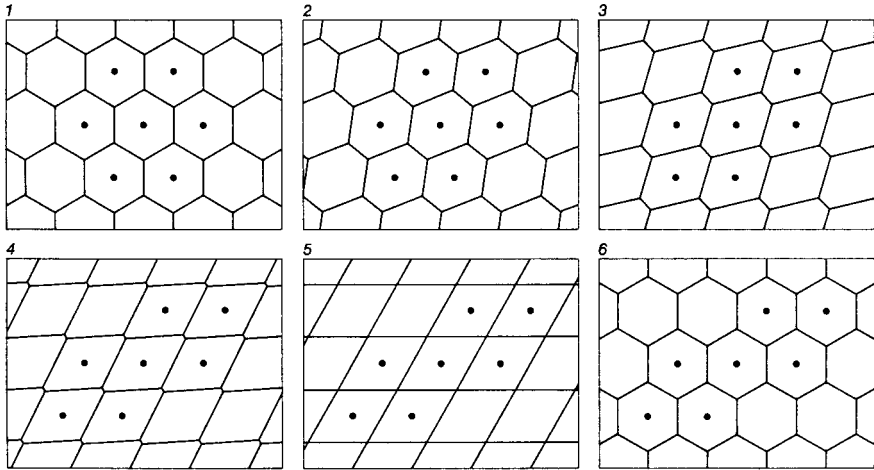
When solids are present in emulsions, the volume fractions of the particles and the droplets are usually not additive for the purpose of predicting overall dispersion viscosity. A number of different kinds of behaviours can result, depending on the sizes and shapes of the particles versus the droplets, and upon whether they exist as kinetically independent entities, whether the particles exist in adsorption layers surrounding the droplets, or dispersed within the droplets themselves, or a combination of all of the above. Pal *et al.* [382] and Nasr-El-Din [85] discuss the rheology of emulsions containing solids in some detail.

Since wet foams contain approximately spherical bubbles, their viscosities can be estimated by the same means that are used to predict emulsion viscosities. In this case the foam viscosity is described in terms of the viscosity of the continuous liquid phase ( $\eta_0$ ) and the amount of dispersed gas ( $\phi$ ). In dry foams, where the internal phase has a high volume fraction the foam viscosity increases strongly due to bubble “crowding,” or structural viscosity, becomes non-Newtonian, and frequently exhibits a yield stress. As is the case for emulsions, the maximum volume fraction possible for an internal phase made up of uniform, incompressible spheres is 74%, but since the gas bubbles are very deformable and compressible, foams with an internal vol-



**Figure 6.22** Illustration of the influence of phase volume fraction on the emulsion type and viscosity of a hypothetical emulsion. In this example emulsion inversion from O/W to W/O occurs over a narrow range of oil volume fractions, centered at  $\phi = 0.74$ .





**Figure 6.23** Shearing stress applied to a bulk foam causing distortion (frames 2–4) and eventually bulk flow once the yield stress is exceeded (frames 5 and 6). Dots in a constellation of cells show how the relative positions of those cells have changed. From Aubert *et al.* [403]. Scientific American Inc.

ume fraction of 99% or more are easy to make. As mentioned earlier, the structure of such a foam consists of irregular polyhedrons with a maximum of three lamella meeting at the plateau borders. Figure 6.23 shows an illustration of foam polyhedra being deformed in the presence of applied shear [403]. Following the cells marked with dots, shows that no flow occurs until there is so much distortion that four films meet at plateau borders. This situation is energetically unstable and also marks the point at which the yield stress is reached. The foam layers will shift to relieve the stress and attain an energetically more favourable structure, restoring the stable three film contacts, resulting in flow.

#### 6.5.6

##### Other Equations

It is not uncommon to encounter emulsions, foams, and suspensions, both in nature and in industry, that contain polymers. If the polymer concentration is high enough, and the dispersed species concentration low enough, the overall viscosity may be better described by the contribution from the polymer solution than that from the dispersed species. One commonly employed equation for describing the viscosity of polymer solutions is the Carreau equation,

$$\eta = \eta_N (1 + (\tau_r \dot{\gamma})^2)^{(n-1)/2} \quad (6.53)$$

where  $\eta_N$  is the low shear Newtonian viscosity,  $\tau_r$  is a rotational relaxation time, and  $n$  is the power-law exponent.

## 6.6 Surface Rheology

The foregoing discussion of rheology has dealt with the bulk viscosity properties. A closely related and very important property is the interfacial viscosity, which can be thought of as the two-dimensional equivalent of bulk viscosity, operative in the interfacial regions in a dispersion. As droplets in an emulsion, or bubbles in a foam, approach each other, the thinning of the films between them, and their resistance to rupture, are thought to be of great importance to the ultimate stability of the overall emulsion or foam. Thus, a high interfacial viscosity can promote emulsion and foam stability by retarding the rate of droplet/bubble coalescence [294,404–407]. As drops approach each other, the rate of oil film drainage will be determined, in part, by the interfacial viscosity which, if high enough, will significantly retard the final stage of film drainage and possibly even provide a viscoelastic barrier to coalescence. More detailed descriptions are given in Refs. [295,408,409]. Further details on the principles, measurement and applications to dispersion stability of interfacial viscosity are reviewed by Malhotra and Wasan [408], and Miller *et al.* [410].

Surface rheology deals with the functional relationships that link the dynamic behaviour of a surface to the stress that is placed on the surface. Both elastic and viscous resistances oppose the expansion and deformation of surface films. The complex nature of these relationships can be expressed in the form of a surface stress tensor [303] in which the isotropic (diagonal) components describe the dilational behaviour of the surface element while the deviatoric (off-diagonal) components relate the resistance to changing the shape of the surface element to the applied shear stresses. Two types of viscosities are defined within the interface, a dilational viscosity and a shear viscosity. For a surfactant monolayer, the surface shear viscosity " $\eta^S$ " is analogous to the three-dimensional shear viscosity: the rate of yielding of a layer of fluid due to an applied shear stress. The phenomenological coefficient " $\kappa^S$ " represents the surface dilational viscosity and expresses the magnitude of the viscous forces during a rate expansion of a surface element.

To illustrate, consider a simplified surface geometry, a soap film that is stretched on a wire frame (see Figure 3.2). For small areal changes, the dynamic tension difference " $\Delta\gamma_d$ " between the starting and ending positions can be approximated by using the surface elasticity,  $E_M$ ,

$$\Delta\gamma_d = E_M \Delta \ln A + (\kappa^S + \eta^S) (d \ln A / dt) \quad (6.54)$$

Unlike in three dimensions, where liquids are often considered incompressible, a surfactant monolayer can be expanded or compressed over a wide area range. Thus, the dynamic surface tension experienced during a rate-dependent surface expansion, is the result of the surface dilational viscosity, the surface shear viscosity, and elastic forces. Often, the contributions of shear and/or the dilational viscosities are neglected during stress measurements of surface expansions. Isolating interfacial viscosity effects is difficult because, since the interface is connected to the substrate on either side of it, the interfacial viscosity is coupled to the two bulk viscosities.

Therefore, it becomes laborious to determine purely interfacial viscosities without the influence of the surroundings.

As bubbles in a foam approach each other, the thinning of the films between the bubbles, and their resistance to rupture, are thought to be of great importance to the ultimate stability of the foam. Thus, a high interfacial viscosity can promote foam stability by lowering the film drainage rate and retarding the rate of bubble coalescence [407]. Fast draining films may reach their equilibrium film thickness in a matter of seconds or minutes due to low surface viscosity, while slow draining films may require hours due to their high surface viscosity. Bulk viscosity and surface viscosity thus do not normally contribute a direct stabilizing force to a foam film but rather act as resistances to the thinning and rupture processes. The bulk viscosity will most influence the thinning of thick films, while the surface viscosity will be dominant during the thinning of thin films.

To the extent that viscosity and surface viscosity influence foam stability, one would predict that stability would vary according to the effect of temperature on the viscosity. Thus some petroleum industry processes exhibit serious foaming problems at low process temperatures, which disappear at higher temperatures. Ross and Morrison [25] cite some examples of petroleum foams that become markedly less stable above a narrow temperature range that may be an interfacial analogue of a melting point.

The presence of mixed surfactant adsorption seems to be a factor in obtaining films with very viscous surfaces [411]. For example, in some cases the addition of a small amount of non-ionic surfactant to a solution of anionic surfactant can enhance foam stability due to the formation of a viscous surface layer, which is possibly a liquid crystalline surface phase in equilibrium with a bulk isotropic solution phase [25,110]. In general, some very stable foams can be formed from systems in which a liquid crystal phase is present at lamella surfaces and in equilibrium with an isotropic interior liquid. If only the liquid crystal phase is present, stable foams are not produced. In this connection foam phase diagrams may be used to delineate compositions that will produce stable foams [25,110].

Adamson [15] and Miller *et al.* [410] illustrate some techniques for measuring surface shear viscosity. Further details on the principles, measurement and applications to foam stability of interfacial viscosity are reviewed by Wasan *et al.* [301,412]. It should be noted that most experimental studies deal with the bulk and surface viscosities of bulk solution rather than the rheology of films themselves.

## 6.7

### Flow in Pipelines and Constraining Media

#### 6.7.1

##### Applications in Pipeline Flow

A number of kinds of emulsions, foams, and suspensions may be made to flow in tubes or pipes, at scales ranging from the laboratory (e.g., capillary viscometers, Section 6.2.1) to full-scale industry (e.g., transportation pipelines, Sections 10.2 and

11.3.4). The pressure drop and pumping requirements are functions of the type of flow and of the rheological properties of the dispersion. If the flow rate in a pipeline falls below the critical deposit velocity then particles or emulsion droplets will either sediment or cream to form a layer on the bottom or top wall, respectively, of the pipe. Some correlations that have been developed for the prediction of critical deposit velocity are discussed by Nasr-El-Din [86] and Shook *et al.* [90].

When the pressure capillary viscometer was described earlier the Poiseuille equation (Eq. (6.13)) was introduced. The converse to using a tube or pipe as a means of measuring viscosity is to use a prior knowledge of viscosity to predict the pressure drop needed to force fluid through the tube or pipe. This pressure difference  $\Delta P$  along a length of tube or pipe,  $L$ , is given by the following rearrangement of Eq. (6.13):

$$\Delta P = 8QL\eta / (\pi r^4) \quad (6.55)$$

where  $Q$  is the volumetric flow rate and  $\eta$  is the Newtonian viscosity.

For Newtonian fluids flowing in smooth pipes, the friction losses can be estimated for laminar flow ( $Re \leq 2100$ ) using the Fanning friction factor,  $f$ . The Reynolds number,  $Re$ , is given by:

$$Re = (\rho UD) / \eta \quad (6.56)$$

where  $\rho$  is the fluid density,  $U$  is the bulk fluid (linear) velocity (m/s), and  $D$  is the pipe inner diameter. The Hagen–Poiseuille equation yields:

$$f = 16/Re \quad (6.57)$$

and the Fanning friction factor is:

$$f = (2\tau_w) / (\rho U^2) \quad (6.58)$$

where  $\tau_w$  is the shear stress at the wall of the pipe.  $\tau_w$  is given in terms of pressure drop,  $\Delta P$ , along a length,  $L$ , of the pipe as:

$$\tau_w = D\Delta P / (4L) \quad (6.59)$$

The shear rate at the wall of the pipe,  $\dot{\gamma}_w$ , is given by:

$$\dot{\gamma}_w = 8U/D \quad (6.60)$$

Combining (6.58) and (6.59) gives,

$$f = \{D / (2 \rho U^2)\} (\Delta P / L) \quad (6.61)$$

For turbulent flow of Newtonian fluids in smooth pipes, two common correlations are those of Blasius [413] for  $3000 \leq Re \leq 100\,000$ :

$$f = 0.079Re^{-0.25} \quad (6.62)$$

and of Drew, Koo, and McAdams [414] for  $3,000 \leq Re \leq 3\,000\,000$ :

$$f = 0.0014 + 0.125Re^{-0.32} \quad (6.63)$$

Equations for a number of non-Newtonian fluid types are available in the literature [213,359]. They tend to be somewhat unwieldy and require a knowledge of the fluid rheology. For power-law fluids in smooth pipes, the friction factor can be estimated by using a modified Reynolds number in Eq. (6.57). The Metzner–Reed modified Reynolds number,  $Re'$ , is given by:

$$Re' = (\rho U^{2-n} D^n) / (K'(8)^{n-1}) \quad (6.64)$$

where  $n$  is the power-law constant (Eq. (6.25)) and  $K'$  is a modified power law constant given by:

$$K' = K \{(1 + 3n)/4n\}^n \quad (6.65)$$

The shear rate at the wall for a power-law fluid in a smooth pipe is given by:

$$\dot{\gamma}_w = (8U/D) \{(1 + 3n)/4n\} \quad (6.66)$$

which reduces to Eq. (6.60) for Newtonian fluids ( $n = 1$ ).

More complex equations have been developed for the flow of power-law fluids under turbulent flow in pipes [85,86,90]. The foregoing applies to smooth pipes. Surface roughness has little effect on the friction factor for laminar flow, but can have a significant effect when there is turbulent flow [85].

**Example.** What would be the pressure drop per unit length for blood (a dispersion of red blood cells in plasma), flowing in an artery which has an internal diameter of 1 mm, in an animal's circulatory system at 37 °C? Assuming a volumetric flow rate of 10  $\mu\text{l/s}$ , the shear rate at the walls would be given by:

$$\dot{\gamma} = 4Q/(\pi r^3) = 102 \text{ s}^{-1}$$

At this shear rate the viscosity of blood would be about 5 mPa·s at 37 °C [415] so the pressure drop per unit length would be:

$$\Delta P/\Delta l = 8Q\eta/(\pi r^4) = 20 \text{ Pa/cm}$$

In reality the situation is more complex because, not only is blood non-Newtonian but blood vessels are neither straight nor rigid, the flow is pulsed rather than steady, and as the tubing diameter decreases, at some point red blood cells begin to be excluded and the viscosity approaches that of plasma alone [415].

### 6.7.2

#### Applications in Porous Media

The flow through porous media of emulsions, foams, and suspensions can be important in a number of applications ranging from fixed-bed catalytic reactors in the chemical process industries, to flows through soil environments, to flow in underground reservoirs. To understand the flow of dispersions in porous media one needs a knowledge not only of the properties of the dispersion, but also of the porous medium. Pore characterization itself has been reviewed elsewhere [30,416].

The ease with which any fluid can flow through a porous medium, the fluid conductivity, is measured as the permeability,  $k$ , of the porous medium, which is defined by Darcy's law as:

$$Q = kA(\Delta P/\Delta l)/\eta \quad (6.67)$$

where  $A$  is the cross-sectional area of the porous medium. This equation assumes a linear, horizontal, isothermal flow of fluid. For flow in more than one direction a more complex version of Eq. (6.67) is needed [108,419]. Also, if two or more immiscible fluids are simultaneously flowing through the porous medium, such as in the flow of emulsions or foams, then the flow process becomes much more complex and the concept of relative permeabilities is needed, in which an equation like (6.67) is written for each of the flowing fluids, and the contribution of each fluid,  $i$ , to flow is:

$$Q_i = k k_{ri} A(\Delta P_i / \Delta l) / \eta_i \quad (6.68)$$

Here the relative permeability,  $k_{ri}$ , is the fraction by which the fluid conductivity of the porous medium has to be modified to account for the presence of the other fluid. For a given fluid,  $k_{ri}$  increases with concentration, but is always less than or equal to one. Since the porous medium will usually have a wetting preference for one fluid over others, there will be a distribution of fluids among the different sizes of pores. Some of the factors that can influence the relative permeability of a particular fluid include [108,417–419]:

- the wetting preference of the solid for the fluid relative to other fluids,
- the pore size and geometry distributions,
- the relative saturation of the fluid compared to other fluids, and the saturation history,
- the densities and viscosities of all of the fluids,

- the interfacial tension between the fluids, and
- the relative flow velocities of the fluids present.

Figure 6.24 (a) and (b) show how the relative permeabilities of oil and water can vary with relative saturation of the pores, and with wettability. This figure also illustrates the fact that the relative permeability of a fluid will become zero while the other fluid still has a finite saturation. This is because a significant amount of either fluid can become immobilized and will not be displaced by the other fluid. The nature and extent of this immobilization depends upon the same factors as just listed for permeability.

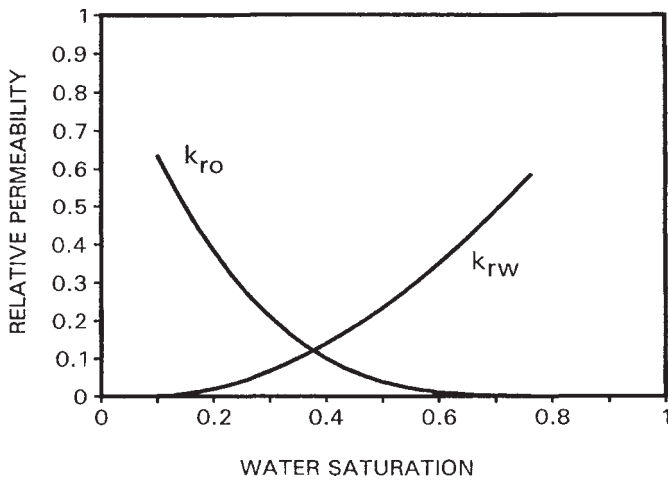
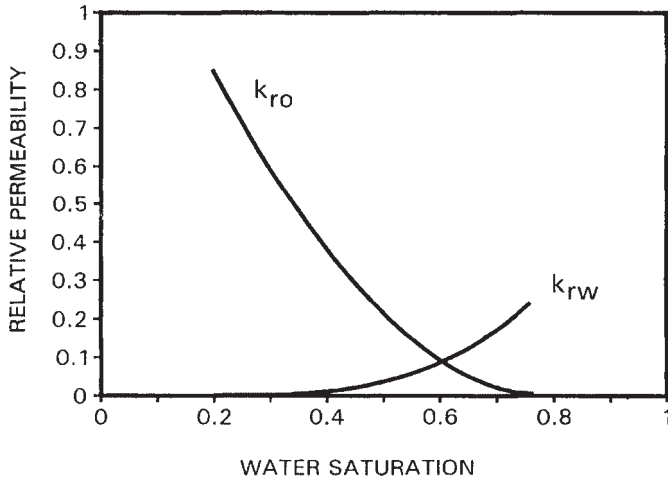
The permeabilities themselves vary widely among natural materials, some approximate values<sup>1)</sup> being:

- $10^{-7} - 10^{-9}$  m<sup>2</sup> for fixed-bed catalysts,
- $10^{-17} - 10^{-9}$  m<sup>2</sup> for common soils,
- $10^{-18} - 10^{-10}$  m<sup>2</sup> for limestone,
- $10^{-16} - 10^{-12}$  m<sup>2</sup> for sandstone,
- $10^{-15} - 10^{-13}$  m<sup>2</sup> for brick.

Additional values are given elsewhere [419].

The flow of emulsions, foams, and suspensions in porous media is more complex due to the nature of the particular dispersion itself. If the droplets, bubbles, or particles are very small compared with the size of the flow channels, then the nature of the dispersed phases can be largely ignored, at least for as long as the dispersion is stable. In most practical cases, however, the sizes of the dispersed species are not much smaller than the pore sizes, if at all, and the the dispersions cannot, then, be treated as pseudo-single-phase. Much more detail is available elsewhere for the flow through porous media of simple fluids [133,420], emulsions [108,227,421], foams [422,423], and suspensions [419,424,425]. See also Sections 11.2.2 and 15.3.

1) In some literature the unit Darcy, D, is still used to denote permeability (1 D = 0.987 × 10<sup>-12</sup> m<sup>2</sup>).



**Figure 6.24**

(a) Relative permeabilities for a water-wet system. ( $k_{ro}$  is the relative oil permeability and  $k_{rw}$  is the relative water permeability). From Kokal *et al.* [108]. Copyright 1992, American Chemical Society.

(b) Relative permeabilities for an oil-wet system. ( $k_{ro}$  is the relative oil permeability and  $k_{rw}$  is the relative water permeability). From Kokal *et al.* [108]. Copyright 1992, American Chemical Society.





## 7

## Preparation, Inhibition, and Destruction of Dispersions

Colloidal dispersions can be formed either by nucleation with subsequent growth or by subdivision processes [12,13,16,25,152,426]. The nucleation process requires a phase change, such as condensation of vapour to yield liquid or solid, or precipitation from solution. Tadros reviews nucleation/condensation processes and their control [236]. Some mechanisms of such colloid formation are listed in Table 7.1. The subdivision process refers to the comminution of particles, droplets, or bubbles into smaller sizes. This process requires the application of shear. Some of the kinds of devices used are listed in Table 7.2 [228].

**Table 7.1** Industrially produced colloidal materials and related processes (from Ref. [426]).

Mechanism	Examples
Vapour → liquid → solid	Oxides, carbides via high intensity arc; metallic powders via vacuum or catalytic reactions.
Vapour + vapour → solid	Chemical vapour deposition, radio frequency-induced plasma, laser-induced precipitation.
Liquid → solid	Ferrites, titanates, aluminates, zirconates, molybdates via precipitation.
Solid → solid	Oxides, carbides via thermal decomposition.

**Table 7.2** Some devices used to produce emulsions and suspensions by comminution (adapted from Ref. [228]).

Device	Mode	Mechanism	Energy input
Chemical stirrer	Batch	Laminar flow/turbulence	Low
Vortex mixer	Batch	Turbulence	Low
Homo mixer	Batch	Turbulence	Moderate
High-pressure homogenizer	Continuous	Turbulence/cavitation	High
Hydro shear	Continuous	Turbulence	High
Colloid mill	Continuous	Laminar flow	Moderate
Flow jet mixer	Batch	Turbulence	Moderate
Ultrasonic disruptor	Batch	Cavitation	High

## 7.1

### Preparation

#### 7.1.1

##### Preparation of Emulsions

Most kinds of emulsions that will be encountered in practice are not formed spontaneously on contact of the phases because they are thermodynamically unstable compared with the separated states. These dispersions can be formed by other means, however. An emulsion can be formed if two immiscible liquids are simply mixed together in a container and then well shaken, but without some kind of stabilizing (emulsifying) agent the emulsion will probably not be very stable. Stabilizing agents for emulsions can comprise one or more of the following: simple inorganic electrolytes, surfactants, macromolecules, or finely divided solids (such as carbon, sulfates, hydroxides, or clay particles with organic coatings [1]). The mechanisms by which emulsifiers stabilize emulsions have been discussed in earlier sections. The emulsifying agent may be needed to reduce interfacial tension, making it easier to create small droplets, or it may be needed to stabilize the small droplets so that they do not coalesce to form larger drops, or even separate out as a bulk phase.

In the classical method of emulsion preparation, the emulsifying agent is dissolved into the phase where it is most soluble, after which the second phase is added, and shear is applied to the mixture using either high-speed mixing or vigorous agitation. For O/W emulsions the agitation must be turbulent and is crucial to producing sufficiently small droplets [427]. Frequently, after an initial mixing, a second mixing with very high applied mechanical shear forces is required. This latter mixing can be provided by a paddle, propeller, or turbine mixer. Frequently a colloid mill or ultrasound generator is employed. A variety of rotor–stator homogenizers are available (colloid mills, pin mills, toothed disc mills) in which the force for disruption comes from the energy of the rotor and the shearing action comes from the narrow gap to the stator [428]. A wide range of other techniques is also now available including, for example, atomizers and nebulizers of various designs used to produce emulsions having relatively narrow size distributions. High shear rates tend to be needed for emulsification into small droplets, while high flow rates tend to be needed for good heat transfer or blending [429]. For W/O emulsions, especially where the oil is fairly viscous, it may be necessary to add the aqueous phase to the oil quite slowly using, for example, a paddle or propeller-type stirrer, and taking care to avoid air entrapment.

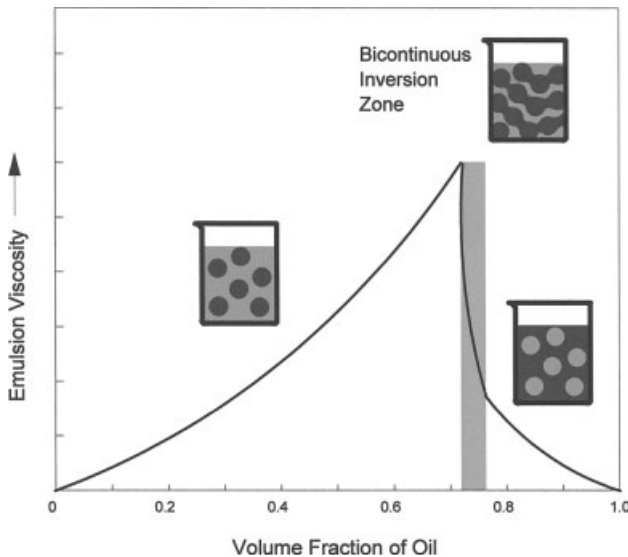
Food emulsions requiring small droplet sizes are frequently made using high-pressure homogenizers, in which a coarse emulsion is passed through a homogenizing valve, slit, or orifice at pressures from about 7–24 MPa (ca. 1000–3500 psi), in which turbulence, cavitation, and velocity gradients provide the drop size reduction [78,428,430]. When dry ingredients are used a liquefier may be employed, which consists of a centrifugal pump with rotating knife blades to chop and mix the ingredients with the liquid [430]. When making high-viscosity emulsions, agitators capable of scraping the walls of the container, such as votators, are used [427,431].

A method requiring much less mechanical energy uses phase inversion, in which the emulsion suddenly changes form, from oil-in-water (O/W) to water-in-oil (W/O), or vice versa. For example, butter results from the creaming, breaking and inversion of emulsified fat droplets in milk. More generally, if ultimately a W/O emulsion is desired, then a coarse O/W emulsion can be first prepared with mechanical energy addition, and the oil content progressively increased. At some volume fraction above 60–70% the emulsion will suddenly invert, producing a W/O emulsion of much smaller water droplet sizes than were the oil drops in the original O/W emulsion (see Figure 7.1).

There are other variations of this approach that involve the phase inversion temperature (PIT) (see Section 3.6.1). In one method an emulsion is formed at a temperature a few degrees lower than the PIT, where the interfacial tension is quite low and small droplets can be formed. The emulsion can then be quickly cooled. Another method uses a controlled temperature change to cause an emulsion to suddenly change from a coarse oil-in-water (O/W) emulsion, through a microemulsion phase, and into a fine water-in-oil (W/O) emulsion [432].

The traditional methods of emulsion preparation, especially those involving stirring and shaking, tend to lead to uncontrolled and wide drop-size distributions. Several methods for the preparation of fairly monodisperse emulsions exist, of which the simplest is probably the extrusion of a dispersed phase through a pipette into a flowing continuous phase. Other, more involved methods are discussed by Mason [433].

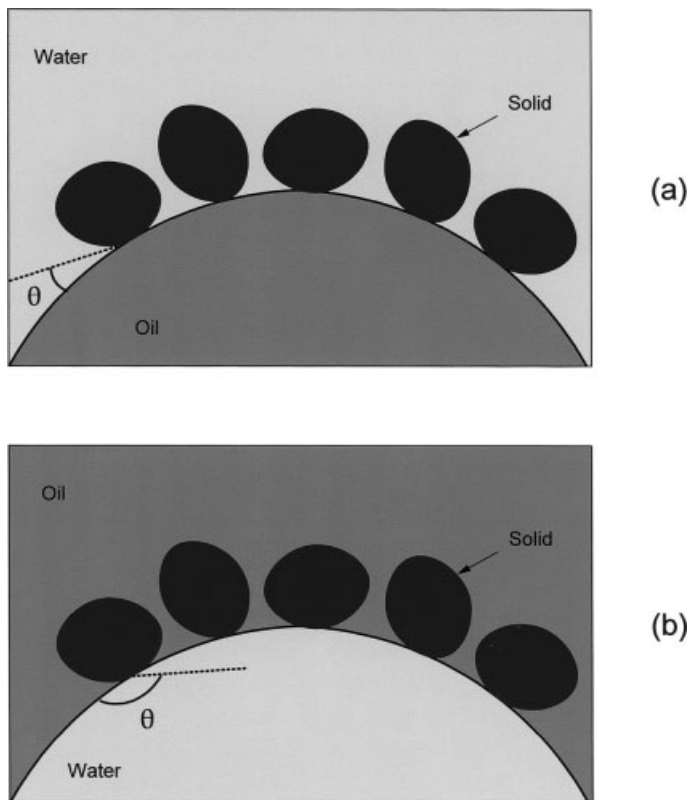
Some of the above emulsion preparation methods are also used as tests of the effectiveness of different surfactants in stabilizing emulsions. For example, the



**Figure 7.1** The influence of volume fraction on the emulsion type and viscosity of a typical emulsion.

Emulsifying Activity Index (EAI) [78] involves making an emulsion, determining the average droplet size (by, for example, turbidimetry), assuming that all of the surfactant is adsorbed (in a monolayer) at the interface, and calculating the area covered per amount of surfactant (in units of  $\text{m}^2/\text{g}$  or  $\text{m}^2/\text{mole}$ ). The Emulsifying Capacity (EC) is determined by dissolving a known amount of surfactant in water, adding oil, and mixing in a blender to form a primary emulsion. Oil is then added until the emulsion inverts, which provides an estimate of the amount of oil that can be emulsified by the specific amount of surfactant used [78]. This test requires standardization of test conditions such as the type of blender, impellor used, time and speed of mixing, and so on. Both kinds of tests provide rough estimates, at best.

There are some rules of thumb for predicting the type of emulsion that will form under certain circumstances. It is emphasized at the outset that there are exceptions to each of these rules, and sometimes one will work where the others do not. They are presented here because they remain useful for making initial predictions.



**Figure 7.2** Illustration of the stabilisation of emulsions by finely divided solids: (a) preferential wetting by water leading to an O/W emulsion; (b) preferential wetting by oil leading to a W/O emulsion.

One rule of thumb for emulsion type states that if an emulsifying agent is preferentially wetted by one of the phases, then more of the agent can be accommodated at the interface if that interface is convex towards that phase – i.e., if that phase is the continuous phase. This is called the oriented-wedge theory and applies for both solids and surfactants as emulsifying agents. For fine solid particles at the liquid/liquid interface, the liquid which preferentially wets the solid particles will tend to form the continuous phase. Thus if there is a low contact angle (measured through the water phase) then an O/W emulsion should form (Figure 7.2). For surfactant molecules this rule of thumb is referred to as Bancroft's rule and can be restated as follows: the liquid in which the surfactant is most soluble becomes the continuous phase. Very often, mixtures of emulsifying agents are more effective than single components. It is thought that some mixed emulsifiers form a complex at the interface, thus yielding low interfacial tension and a strong interfacial film.

A second general rule specifies that soaps of monovalent metal cations tend to produce O/W emulsions, while those of polyvalent metal cations will tend to produce W/O emulsions. Figure 7.3 illustrates the concept. In the example shown, the calcium ions each coordinate to two surfactant molecules that are aligned with their polar groups near the metal ion. This forces the hydrocarbon tails into a wedge-like orientation. The hydrocarbon tails in a close-packed interfacial layer are most easily accommodated if the oil phase is the continuous phase. Thus, the oriented-wedge

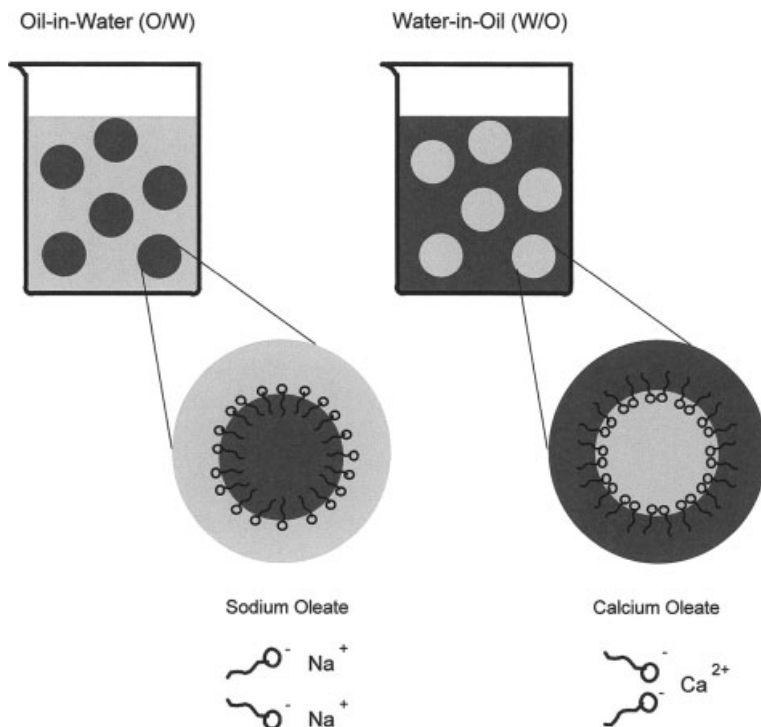


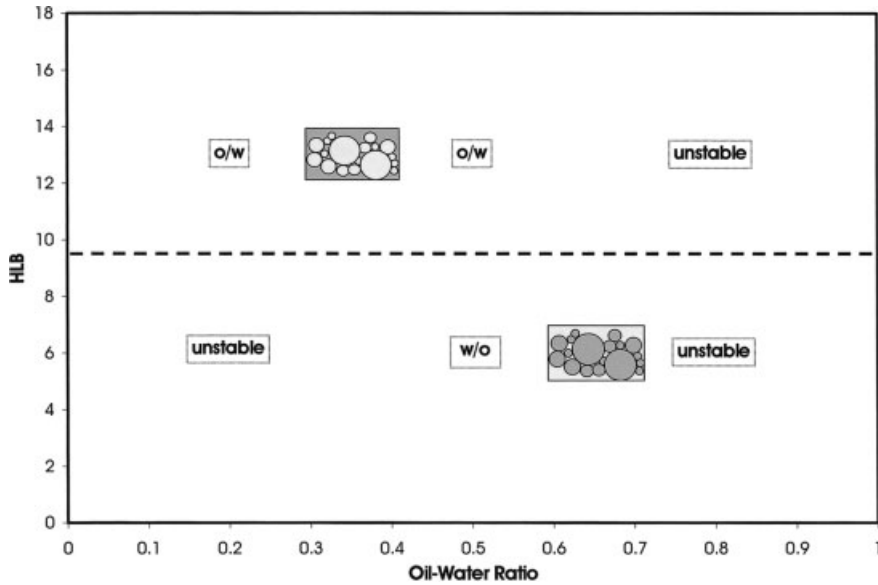
Figure 7.3 Illustration of the oriented-wedge theory of emulsion type.

theory predicts that the calcium soap will produce a water-in-oil emulsion. For the sodium soap, the charged polar groups of the surfactant tend to repel each other more strongly. This, together with the single cation-surfactant coordination, makes it most favourable for the polar groups to be in the continuous phase, and an oil-in-water emulsion results (Figure 7.3).

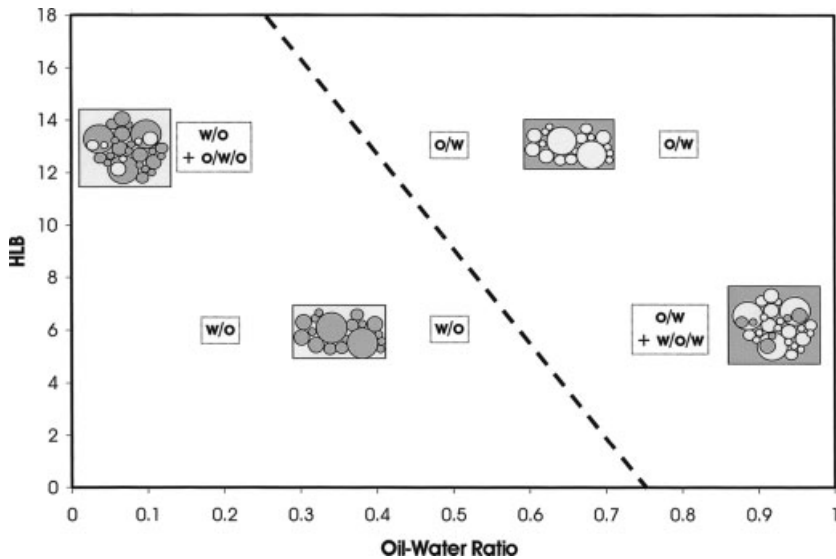
The HLB concept, introduced in Section 3.6.1 is probably the most useful approach to predicting the type of emulsion that will be stabilized by a given surfactant or surfactant formulation. The HLB concept was introduced [207,209] as an empirical scale that could be used to describe the balance of the size and strength of the hydrophilic and lipophilic groups on an emulsifier molecule. Originally used to classify Imperial Chemical Industries' non-ionic surfactant series of "Spans" and "Tweens" the HLB system has now been applied to many other surfactants, including ionics and amphoteric.

The HLB scale ranges from 0 to 20 for non-ionic surfactants. A low HLB (<9) refers to a lipophilic surfactant (oil soluble) and a high HLB (>11) to a hydrophilic (water soluble) surfactant. Most ionic surfactants have HLB values greater than 20. Some examples of surfactant HLBs are given in Table 3.5. In general, water-in-oil (W/O) emulsifiers exhibit HLB values in the range 3–8 while oil-in-water (O/W) emulsifiers have HLB values of about 8–18. There exist empirical tables of HLB values required to make emulsions out of various materials [209,210]. If the value is not known, then lab emulsification tests are required, using a series of emulsifying agents of known HLB values [210]. There are various compilations and equations for determining emulsifier HLB values [96,207,209–211].

There is some evidence to suggest that, depending upon the phase volume ratios employed, the emulsification technique used can be of greater importance in determining the final emulsion type than the HLB values of the surfactants themselves [434]. As an empirical scale the HLB values are determined by a standardized test procedure. However, the HLB classification for oil phases in terms of the required HLB values is apparently greatly dependent on the emulsification conditions and process for some phase-volume ratios. When an emulsification procedure involves high shear, or when a 50/50 phase volume ratio is used, interpretations based on the classical HLB system appear to remain valid. However, at other phase-volume ratios and especially under low shear emulsification conditions, inverted, concentrated emulsions may form at unexpected HLB values [434]. This is illustrated in Figures 7.4 and 7.5.



**Figure 7.4** Observed emulsion tendency as a function of HLB and oil-water ratio for kerosene/water emulsions prepared under high shear. From Vander Kloet and Schramm [434]. Copyright 2002, American Oil Chemists Society.



**Figure 7.5** Observed emulsion tendency as a function of HLB and oil-water ratio for kerosene/water emulsions prepared under low shear. From Vander Kloet and Schramm [434]. Copyright 2002, American Oil Chemists Society.



**Example.** It is desired to make a 15% O/W emulsion of a paraffinic mineral oil. Using a series of blends of emulsifiers A (HLB 4.7) and B (HLB 14.9), a set of emulsion tests are performed, with the following results:

Emulsifier blend	HLB	Emulsion test
100% A	4.7	No emulsion
87% A + 13% B	6	No emulsion
68% A + 32% B	8	Moderate emulsion
48% A + 52% B	10	Stable emulsion
28% A + 72% B	12	Moderate emulsion
6% A + 94% B	14	No emulsion
100% B	14.9	No emulsion

In this case, an HLB of 10 is required to make the O/W mineral oil emulsion.

There also exist empirical equations for calculating HLB values. For example, in the case of polyoxyethylene alcohols  $C_nH_{2n+1}(OCH_2CH_2)_mOH$ , a class of non-ionic surfactants, the HLB can be calculated from:

$$HLB = E/5 \quad (7.1)$$

where E is the percentage by mass ethylene oxide in the molecule. Experimentally, the unknown HLB of an emulsifier can be determined by mixing it with an emulsifier of known HLB, and an oil for which the HLB required for emulsification is known. A series of tests such as illustrated in the above example can be used to determine the unknown HLB.

Some limitations of the HLB system are that other factors are also important and also that HLB is an indicator of the emulsifying characteristics, but not the efficiency of an emulsifier. Thus while all emulsifiers having a high HLB will tend to promote O/W emulsions, there will be a considerable variation in the efficiency with which those emulsifiers act for any given system. The HLB of the emulsifier needed to make a good emulsion also increases as the polarity of the oil to be emulsified (in an O/W emulsion) increases [193]. Also, mixtures of emulsifying agents are more effective than single components, even if the final HLB is the same. It is thought that some mixed emulsifiers form a complex at the interface, thus yielding low interfacial tension and a strong interfacial film. For example, mixtures of polyoxyethylene surfactants containing both short polyoxyethylene chains (low HLB) and long polyoxyethylene chains (high HLB) produce better emulsions than surfactants with a narrow range of polyoxyethylene content [193].

Just as solubilities of emulsifying agents vary with temperature, so does the HLB, especially for the non-ionic surfactants. A surfactant may thus stabilize O/W emulsions at low temperature, but W/O emulsions at some higher temperature. The phase inversion temperature (PIT), at which the surfactant changes from stabilizing O/W to W/O emulsions, is discussed in Section 3.6.1.

There are many industrial processes in which the formation of low internal phase or concentrated emulsions needs to be controlled, whether in terms of formation, stability, destruction or prevention. Examples range from asphalt emulsions to per-

sonal care products, to food products. Success in emulsion control requires achieving the right physical chemistry and also the right fluid mechanics. In addition to HLB (see Section 7.1.1), both the nature of the emulsification method and the oil–water ratio are critical in determining the produced emulsion type. It appears that the emulsification technique (applied shear and oil–water ratio) used, can be of greater importance in determining the final emulsion type than the HLB values of the surfactants themselves.

Low internal phase emulsions typically result when high shear conditions are used for emulsification, while low shear mixing can lead to high internal phase, or concentrated, emulsions [435]. There are several conditions needed to form a concentrated emulsion. Low shear mixing is required while the internal phase is slowly added to the continuous phase, and the surfactants used to create the emulsion need to be able to form elastic films [435–438]. The formation of concentrated emulsions has also been linked to surfactant–oil phase interactions [436] and therefore the oil–water interfacial tension and the potential for surfactant–surfactant interactions [439].

The principles discussed in this section can be applied to the preparation of multiple emulsions. An O/W/O multiple emulsion can be created by, for example, first making a stable “primary” O/W emulsion using a high-HLB surfactant and a mechanical stirrer. The primary emulsion is then itself emulsified into an oil phase that contains a low-HLB surfactant, this time employing gentle, low-shear agitation. The result is an O/W/O multiple emulsion. Some care is needed in the selection of the two emulsifying surfactants. The first surfactant in this case (high HLB) should provide a strong interfacial film in order to protect the droplets during the subsequent preparation steps, and also later, during storage. The second surfactant in this case (low HLB) should provide a barrier to aggregation and coalescence. Variations on this approach are discussed by Seiller *et al.* [440] and Bibette *et al.* [441]. Caution is needed in the applications of shear, especially during the second emulsification step and subsequently [52]. If, for example, high-speed homogenization is applied it will cause release of the internal oil droplets [442]. A polymer coating on the exterior surfaces of the O/W/O droplets can provide additional stability [236].

### 7.1.2

#### Preparation of Foams

If a gas and a liquid are mixed together in a container and then shaken, a foam will be formed. A foam structure can always be formed in a liquid if bubbles of gas are injected faster than the liquid between bubbles can drain away. Even though the bubbles coalesce as soon as the liquid between them has drained away, a temporary dispersion is formed. An example would be the foam formed when bubbles are vigorously blown into a viscous oil<sup>1)</sup>. Such a foam, comprising spherical, well separated

1) Wet foams in which the liquid lamellae have thicknesses on the same scale as the bubble sizes are sometimes referred to as “gas emulsions”.

Typically, in these cases the gas bubbles have spherical, rather than polyhedral shape.

bubbles, is referred to as a wet foam, or Kugelschaum. Here, the distinction of whether one should consider this to be a foam or not relates to stability. But it is complicated by the fact that, as for other types of colloidal dispersions, no foams are thermodynamically stable. Eventually they all collapse.

In pure liquids, gas bubbles will rise up and separate, more or less according to Stokes' law. When two or more bubbles come together coalescence occurs very rapidly, without detectable flattening of the interface between them, i.e., there is no thin-film persistence. It is the adsorption of surfactant, at the gas-liquid interface, that promotes thin-film stability between the bubbles and lends a certain persistence to the foam structure. Here, when two bubbles of gas approach, the liquid film thins down to a persistent lamella instead of rupturing at the point of closest approach. In carefully controlled environments, it has been possible to make surfactant-stabilized, static, bubbles, and films with lifetimes on the order of months to years [45].

Most foams having any significant persistence contain gas, liquid, and a foaming agent. The foaming agent may comprise one or more of the following: surfactants, macromolecules, or finely divided solids. The foaming agent is needed to reduce surface tension and thereby aid in the formation of the increased interfacial area with a minimum of mechanical energy input, and it may be needed to form a protective film at the bubble surfaces that acts to prevent coalescence with other bubbles. Stability against thin-film rupture and bubble coalescence can be further enhanced by the inclusion of agents that increase viscosity and retard evaporation. For example, a common way to increase the persistence of both foams and "soap" bubbles is to add glycerin to the foaming solution. Glycerin increases the solution viscosity and also forms weak hydrogen bonds with water, delaying evaporation.

Although many factors, such as film thickness and adsorption behaviour, have to be taken into account, the ability of a surfactant to reduce surface tension and contribute to surface elasticity are among the most important features of foam stabilization (see Section 5.4.2). The relation between Marangoni surface elasticity and foam stability [201,204,305,443] partially explains why some surfactants will act to promote foaming while others reduce foam stability (foam breakers or defoamers), and still others prevent foam formation in the first place (foam preventatives, foam inhibitors). Continued research into the dynamic physical properties of thin-liquid films and bubble surfaces is necessary to more fully understand foaming behaviour. Schramm *et al.* [306] discuss some of the factors that must be considered in the selection of practical foam-forming surfactants for industrial processes.

The actual generation of a foam can be accomplished by a variety of methods, from some that are extremely simple to some that are quite complex (see also Section 2.6.2). Some examples include:

- bubbling gas into a liquid or solution,
- causing a stream of liquid to fall onto a pool of liquid or solution, thereby engulfing air bubbles,
- suddenly reducing the pressure on a solution of dissolved gas, causing rapid nucleation and growth of gas bubbles within the solution,

- turbulent mixing such that air is whipped into a liquid or solution, as with a beater, paddle- or propeller-stirrer, vortex mixer, blender, etc.,
- co-injecting gas and liquid into a mechanical foam generator, which uses pressure drop, turbulence and/or tortuous flow pathways to cause bubble pinch-off and sub-division.

### 7.1.3

#### Preparation of Suspensions

Suspensions can be formed either by nucleation or by subdivision and dispersion. The nucleation process requires a phase change, such as condensation of vapour to yield solid, or precipitation of a salt from a supersaturated solution. In the latter case a supersaturated solution must be formed. The supersaturation condition is then alleviated by condensation on nuclei (which need not be composed of the same material) already present, or else by formation of nuclei with subsequent condensation. The nuclei eventually grow to microscopic, or macroscopic, size. Additional details of this process are discussed elsewhere [49,320].

Condensation is common in geologic systems, particularly in the hydrosphere. For example, clay minerals can be precipitated directly from solution, and several polyvalent metal cations (including aluminum, iron, manganese, calcium, and magnesium) hydrolyze in aqueous solution to form a variety of sparingly soluble hydrous oxides and hydroxides. These tend to be quite sensitive to acid/base (pH) and oxidizing/reducing (Eh) conditions so that the chemistry of naturally occurring suspensions in natural waters is very complex (see also Yariv and Cross [49], Morgan and Stumm [315], and Hem [444]). In the laboratory setting, an example of the condensation method is provided by the mixing of a silver salt and an iodide. Here, silver iodide is formed as a number of AgI nuclei which then grow. A slight excess of either the silver salt or the iodide causes the particles to acquire a positive or negative surface charge, respectively, which can stabilize the suspension.

Subdivision (dispersion) is also common in geologic systems. In this case dispersion involves weathering of parent rock (physical disintegration and/or chemical dissolution with re-precipitation) followed by suspension of the particles in liquid. The physical disintegration can be caused by a range of events [49]:

- freeze/thaw cycles crushing particles held in the cracks in boulders,
- collisions between the ground and windborne particles,
- collisions between stream- and river-beds, and waterborne particles,
- erosion due to wave action,
- crushing and grinding by glaciers,
- erosion due to the impacts of falling and/or rolling rocks,
- crushing and grinding by plant roots,
- explosive activity of volcanoes.

These are significant activities, that occur repeatedly over many cycles. According to Yariv and Cross “during the geologic history of the earth more than 70% of weath-

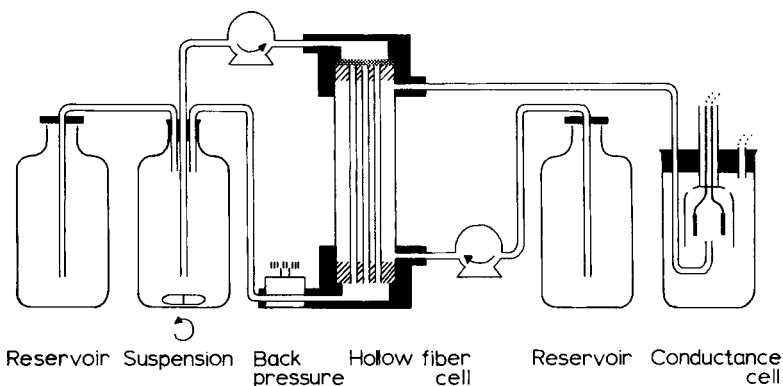
ered magmatic or metamorphic rocks have been reduced in grain size from diameters between 0.1 to several millimetres, to diameters of less than  $20\ \mu\text{m}$ " [49].

Another example of subdivision/dispersion is given by the classic disintegration of metals that occurs when two electrodes of the same metal are submersed and subjected to an electric potential that causes arcing (Bredig's arc). Here, metal melts at the electrode tips and becomes dispersed into suspension. Such suspensions can be stabilized by the presence of peptizing electrolyte.

In industrial and laboratory settings the subdivision process more commonly involves the comminution of large particles or aggregates into smaller sizes, either dry with subsequent dispersion (size reduction to the order of a few  $\mu\text{m}$ ) or directly in a slurry (size reduction to as small as a few tenths of  $\mu\text{m}$ ). Examples of comminution machines include agitator ball mills, colloid mills, cutting mills, disk mills, homogenizers, jet mills, mechanical impact mills, ring-roller mills, and roll crushers.

For clay minerals the natural processes of weathering and erosion tend to produce small particle sizes so that usually only mild dispersion in simple mixers, blenders, or ultrasonic baths are required. Also for clays, having inherent lattice charge means that when in contact with water an electric double layer is immediately created and no stabilizing (peptizing) electrolyte may be needed in this case. The converse may also apply. That is, a sample may contain too much electrolyte to be easily dispersed. Clay and other suspensions that contain a large, aggregating amount of electrolyte can be purified by a number of means to remove this electrolyte and create a reasonably stable dispersion.

- Sedimentation or centrifuging can be alternated with dilution with de-ionized water in order to progressively reduce the electrolyte to a concentration at which the dispersion becomes stable.
- Ultrafilters can be used to permit sequential washing and filtering, after which the filter cake is redispersed into suspension, or continuous hollow-fibre ultrafiltration can be used to accomplish the same result (see Figure 7.6).



**Figure 7.6** Continuous flow hollow fibre apparatus for washing (desalting) and making homoionic clay suspensions. From Schramm [55]. Copyright 1980, Laurier L. Schramm.

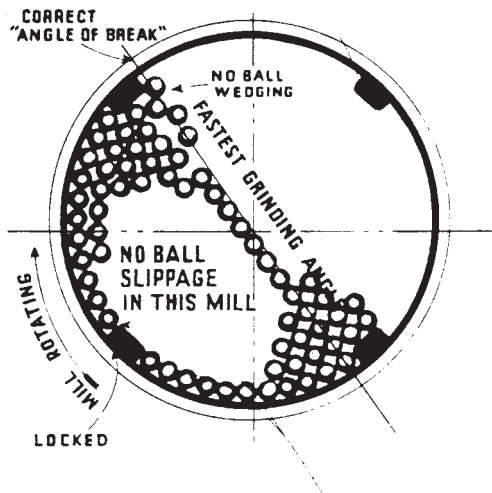
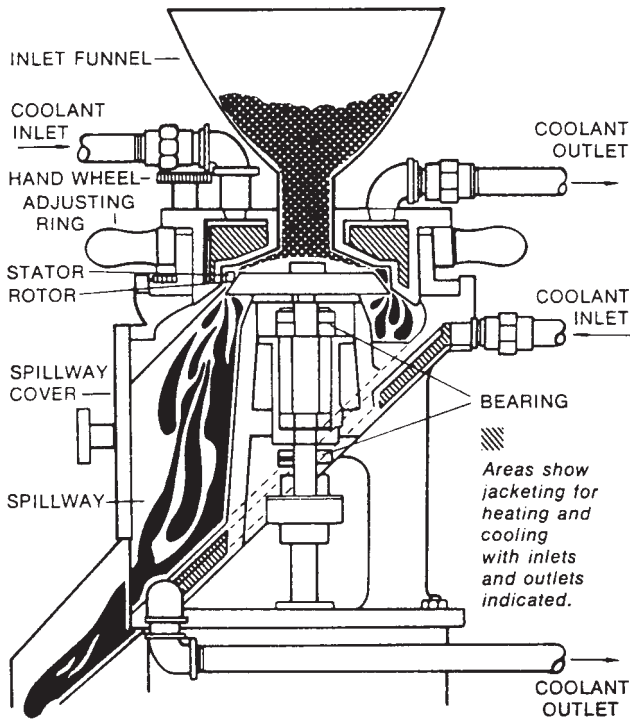
- Either batch or continuous dialysis can be applied in the same manner [445].
- Electrodialysis can be used, as described in Section 4.3.3.

For other solids, high-energy and physical impact may be required to achieve small particle sizes. This is accomplished by applying high energy (high shearing forces) to break apart aggregates or to shatter particles, using devices such as a propeller-style mixer, grinding mill, colloid mill, or ultrasound generator. In some cases, when using grinding in ball or pebble mills, sequences of grinding, employing progressively finer grinding media, may be required to achieve very fine particle sizes. Figure 7.7 shows examples of (a) a colloid mill and (b) a ball mill. The principles and operation of several kinds of dispersing equipment are discussed by Ross and Morrison [25] and others [37,93,446,447]. Factors that aid in the preparation of a suspension include favourable wetting conditions, the absence of strongly bound aggregates, fluid motions in the mixing cell that will submerge the particles, and shear, to aid in disaggregation.

A complex technology has developed to conduct and to control comminution and size-fractionation processes. Fallenius [448] presents criteria for use in scaling turbine and propeller mixers and flotation cells. Mathematical models are also available to describe changes in particle-size distribution during comminution, although these are generally restricted to specific processes. Further details are available elsewhere [57,58,449]. Laskowski and Pugh [84] describe and classify the major kinds of inorganic and polymeric dispersing agents used in mineral processing.

Colloidal suspensions of uniform chemical and phase composition, particle size, and shape are now available for many elements (including sulfur, gold, selenium, and silver, carbon, cobalt, and nickel), many inorganic compounds (including halide salts, sulfates, oxides, hydroxides, and sulfides), and many organic compounds (including, poly(vinyl acetate), polystyrene, poly(vinyl chloride), styrene-butadiene rubber, poly(acrylic acid), polyurea, poly(styrene)-poly(acrylate), and poly(methacrylate)-poly(acrylate). Monosized powders and monodispersed colloidal sols are frequently used in many products, e.g., pigments, coatings, and pharmaceuticals.

Particularly thixotropic suspensions can be prepared in oleic media using organoclays. These can be prepared from Wyoming bentonite or hectorite by, for example, washing the clay and converting it to homo-ionic sodium form, then mixing it with a quarternary amine surfactant. Such organoclays have been used in cosmetics, greases, inks, and oil-based drilling fluids.



**Figure 7.7** Examples of (a) a colloid mill and (b) a ball mill used for the preparation of suspensions by the dispersion method. Figure (a) courtesy Premier Mill, Reading, PA; Figure (b) courtesy Paul O. Abbé Inc., Little Falls, NJ.

## 7.1.4

**Ostwald Ripening**

Having prepared an emulsion, foam, or suspension, changes in the sizes of the dispersed droplets, bubbles, or particles may begin immediately due to Ostwald ripening. This results from the usually limited but still finite solubility of the dispersed phase. There will be a difference between the solubility of small versus large droplets, bubbles, or particles, with the smaller species having the greater solubility due to the effect of curvature on surface free energy. This causes the smaller species to disappear, slowly over time, with the dissolved material being transferred to the larger species. Hence, the larger droplets, bubbles, or particles tend to grow larger while the smaller species grow smaller. From the point of view of dispersion stability this process is almost always undesirable because the larger species will have greater rates of sedimentation or creaming.

One approach to reducing the rate of Ostwald ripening involves adsorbing surfactants and/or polymers at the interfaces, which can hinder the rate of incorporation of new molecules into dispersed species. However, there can be an increase in the rate of Ostwald ripening above the cmc [450]. Another approach involves adding components that reduce the rate of diffusion of molecules within the dispersed species. An example is the possibility of treating O/W emulsions by adding a small amount of highly insoluble oil to the dispersed oil drops, which reduces the rate of diffusion of the original oil molecules [236].

## 7.2

**Destruction and/or Inhibition**

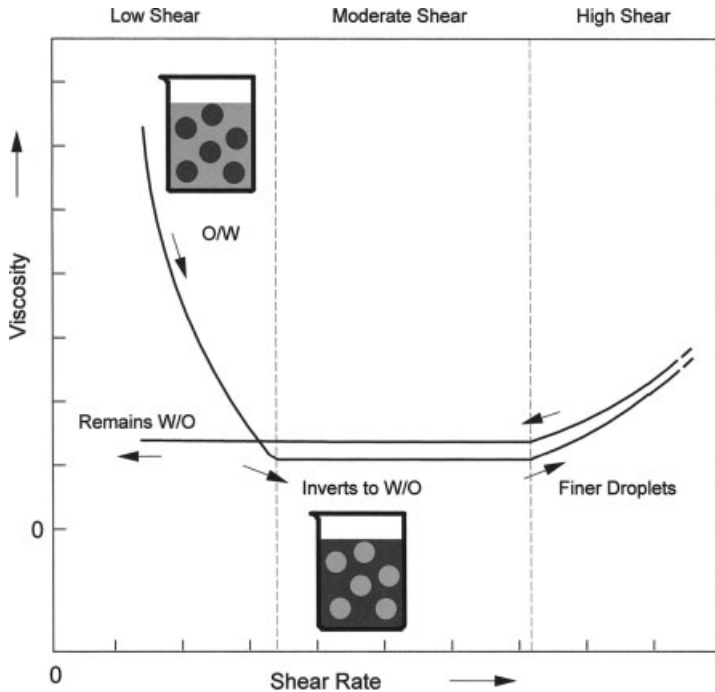
## 7.2.1

**Demulsification**

Some emulsions are undesirable when they occur. In process industries chemical demulsification is commonly used to separate water from oil in order to produce a fluid suitable for further processing. The specific kind of emulsion treatment required can be highly variable, even within the same industry. The first step in systematic emulsion breaking is to characterize the emulsion in terms of its nature (O/W, W/O, or multiple emulsion), the number and nature of immiscible phases, the presence of a protective interfacial film around the droplets, and the sensitivity of the emulsifiers [295,408,451]. Demulsification then involves two steps. First, there must be agglomeration or coagulation of droplets. Then, the agglomerated droplets must coalesce. Only after these two steps can complete phase separation occur. It should be realized that either step can be rate determining for the demulsification process.

Sometimes an emulsion can be broken by changing the temperature or by applying mechanical shear. The temperature can be increased, for example, to cause crystalline or semi-crystalline components, such as paraffins, to melt, or to approach the





**Figure 7.8** Example of the shear-induced inversion of an emulsion of diluted bitumen in water. Based on data from Schramm [95].

boiling point of water [452]. Figure 7.8 shows the irreversible inversion of a diluted bitumen-in-water emulsion brought about by the application of shear [453]. In other cases emulsions can be broken by separating out and concentrating the dispersed phase, such as by membrane ultrafiltration [454]. More commonly, chemical addition is needed to neutralize the effect of the emulsifier, followed by mechanical means to complete the phase separation. A wide range of chemical demulsifiers are available in order to effect this separation [455–459]. Selecting the best demulsifier, however, is complicated by the wide range of factors that can affect demulsifier performance, including oil type, the presence and wettability of solids, oil viscosity, and the size distribution of the dispersed water phase.

If an emulsion is stabilized by electrical repulsive forces, then demulsification could be brought about by overcoming or reducing these forces. In this context the addition of electrolyte to an O/W emulsion could be used to achieve the critical coagulation concentration, in accord with the Schulze–Hardy rule.

More commonly, demulsifiers are surface-active substances (surfactants) that have the ability to destabilize emulsions. This involves reducing the interfacial tension at the emulsion interface, often by neutralizing the effect of other surfactants that are stabilizing the emulsion. An example is antagonistic action – the addition of an O/W promoter to break a W/O emulsion (see sensitization in Section 5.4). Mikula

and Munoz [68] trace the historical evolution of demulsifier chemistry and effective concentration range. Several reviews of demulsifier chemistry and properties are also available [452,458–465]. In order to perform, a demulsifier should:

- migrate rapidly through the continuous phase to reach the droplet interface,
- have a strong attraction to the interface,
- displace or otherwise counteract the emulsifying agent stabilizing the emulsion, and
- promote aggregation and coalescence of the dispersed phase into large droplets that can settle out, or otherwise be separated, from the continuous phase.

Ideally, all of these actions happen quickly, resulting in the separation of the oil and water phases.

The presence of solids further complicates the performance requirements for a demulsifier. Emulsions stabilized by fine particles can usually be broken if the wettability of the particles is reversed. Inorganic particles, such as iron sulfides or clay minerals, can be made water-wet, causing them to leave the interface and diffuse into the water phase, or they can be made oil-wet so that they leave the interface and diffuse into the oil phase [68]. Organic particles, such as paraffins and asphaltenes, can be removed from interfaces by dissolution [461,463,466].

A number of parameters are used to select demulsifiers [68,465,467], including:

- basic physical properties like molar mass, interfacial tension, and partition coefficient,
- performance properties like hydrophile–lipophile balance (HLB), relative solubility numbers (RSN), hexane acetone titration (HAT), preferred alkane carbon number, and
- compositional correlations, like principal component analysis [68].

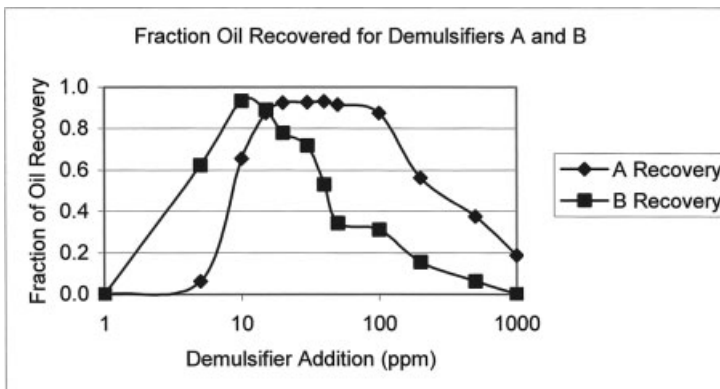
Work on the characterization of oil-field emulsions coupled with chemical characterization of commercially available demulsifier formulations has shown that physical processes (temperature, pumping, and dispersed water size distribution) can be at least as important as the chemical effects associated with demulsifiers themselves in determining demulsifier effectiveness [468,469]. In fact, there are so many variables involved in industrial demulsification that, to a large degree, demulsifier selection and performance evaluation are still conducted using simple test procedures developed for use in the plant or field. These tests, usually bottle or centrifuge tests, can be good indicators of performance trends, and are usually carried out for selected suites of commercial demulsifier formulations.

Another important parameter in characterizing demulsifier performance is the range of effective concentrations. Demulsifiers are very prone to overdosing, so that a judgement of the effective range of demulsifier concentrations is usually required. For processes with very consistent feeds, with little variation in feed properties, the best choice is likely to be the demulsifier with the best absolute performance and lowest required addition rate. In many processes, however, variations in feed, results in significant swings in optimum demulsifier concentration and, without a demulsifier that performs well over a range of dosages, overall effectiveness will be reduced.

Therefore, a demulsifier with poorer performance but a wider range of effective concentrations is usually better in the plant or the field. Product quality is only one factor in defining demulsifier performance, overtreatment, which can lead to rag layer formation, also needs to be avoided. Figure 7.9 shows two separator oil recovery curves showing different oil losses to rag layer formation.

There are also process-specific considerations. For example, a long-residence-time settling vessel might allow the use of a demulsifier that diffuses to the interface slowly, but which produces a very well resolved (separated) emulsion, whereas a centrifuge process (having a short residence time) may require a demulsifier that diffuses to the emulsion interface rapidly, but is slightly less effective at emulsion breaking [68].

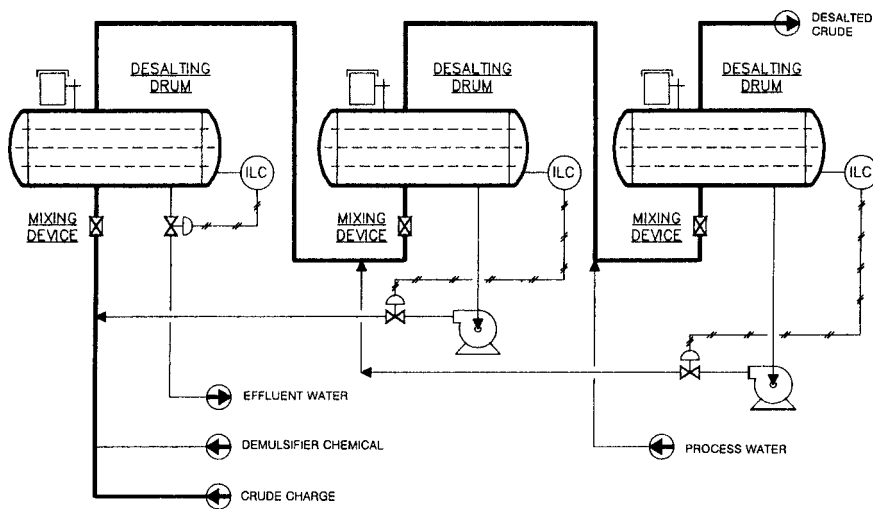
Some examples of the primary active agents in commercial demulsifiers include ethoxylated (cross-linked or uncross-linked) propylene oxide/ethylene oxide polymers or alkylphenol resins. These products are formulated to provide specific properties including hydrophile-lipophile balance (HLB), solubility, rate of diffusion into the interface, and effectiveness at destabilizing the interface [452,470]. Some surfactants are more effective at preventing rag layer (emulsion) formation and others are more effective over wide concentration ranges, and therefore less susceptible to overdosing. Demulsifier blends are often employed to match such conflicting requirements. There are also families of demulsifier chemicals that can be tailor-made to accommodate different emulsion types by adjusting surface activity and the rate at which the demulsifiers move to the interface. A wide range of demulsifying agents are used [38,99,295,408,452,459,461,462,464,465,471–481].



**Figure 7.9** Total oil recovery for demulsifiers A and B as a function of addition rate. Demulsifier B is effective at a much lower addition rate, but rag layer formation affects the recovery, resulting in a narrow range of effective concentration. Demulsifier A requires a higher addition rate, but is not as susceptible to overtreatment.

Wide variation in feed properties would make demulsifier A the better choice because of its wider range of effective concentrations, in spite of the fact that demulsifier B has the same performance at about half the addition rate. From Mikula and Munoz [68]. Copyright 2000, Cambridge University Press.

Apart from the above noted chemical treatments, a variety of physical methods are used in emulsion breaking. The vessels used have names such as separators, treaters, electrostatic desalters, gun barrel settlers, and free-water knockouts (FWKOs) [2]. These are all designed to accelerate coagulation and coalescence, and sometimes to remove gases as well. For example, W/O emulsions may be treated by some or all of settling, heating, electrical dehydration, chemical treatment, centrifugation, and filtration. The mechanical methods, such as centrifuging or filtering rely on increasing the collision rate of droplets, and applying an additional force driving coalescence. An increase in temperature will increase thermal motions to enhance the collision rate, and also reduce viscosities (including interfacial viscosity), thus increasing the likelihood of coalescence. In the extremes, very high temperatures will cause dehydration due to evaporation, while freeze-thaw cycles will break some emulsions. Electrical methods may involve electrophoresis of oil droplets, causing them to collide, to break O/W emulsions. With W/O emulsions, the mechanism involves deformation of water droplets, since these are essentially non-conducting emulsions. Here the electric field causes an increase in the droplet area, disrupting the interfacial film. Increased droplet contacts increase the coalescence rate, breaking the emulsion. Figure 7.10 shows an example. More details on the application of these methods in large-scale continuous processes are given in references [99,452,482].



**Figure 7.10** Illustration of a three-stage electrostatic desalting (emulsion breaking) system. From Grace [452]. Copyright 1992, American Chemical Society.

## 7.2.2

**Antifoaming and Defoaming**

Several reviews of foam inhibiting and defoaming are available [281,327,483–486]. Unwanted foaming occurs in many industrial processes, leading to the use of anti-foaming and/or defoaming agents [43,46,484]. Some agents will act to reduce the foam stability of a system (termed foam breakers or defoamers) while others can prevent foam formation in the first place (antifoamers, foam preventatives or foam inhibitors). There are many such agents; an example of which is poly(dimethylsiloxane),  $(\text{CH}_3)_3\text{SiO}[(\text{CH}_3)_2\text{SiO}]_x\text{R}$ , where R represents any of a number of organic functional groups. Kerner [327] describes several hundred different formulations for foam inhibitors and foam breakers. Although these materials are not necessarily surfactants themselves, their relevance to surfactants is that in all cases the cause of the reduced foam stability can be traced to various kinds of changes in the nature of the surfactant-stabilized interface.

The addition to a foaming system of any soluble substance, that can become incorporated by co-solubilization or by replacement of the original surfactants into the interface, may decrease dynamic foam stability if the substance acts against the formerly present stabilizing factors, such as surface elasticity, and surface viscosity. Some branched, reasonably high molecular mass alcohols can be used for this purpose. Not being very soluble in water, they tend to be adsorbed at the gas/liquid interface, displacing foam promoting surfactant and breaking or inhibiting foam. Similarly the poly(dimethylsiloxane)s, already mentioned, and perfluorohydrocarbons, with their very low surface tensions, can be effective antifoamers. A unique feature of the poly(dimethylsiloxane)s and perfluorohydrocarbons is their ability to act as antifoamers for either aqueous or hydrocarbon foams. Even hydrocarbon vapours have been found to exhibit foam-inhibiting action, apparently by co-adsorbing at the interface and causing an increase in the surfactant concentration required for foam stabilization [487]. Alternatively, a foam can be destroyed by adding a chemical that actually reacts with the foam-promoting agent(s).

Any additives that can act to reduce the viscosity of foam films, and thereby increase the liquid drainage rate, will tend to reduce foam stability as a result. This includes any chemicals that can reduce surface viscosity and/or surface elasticity. Some alcohols can be used to produce these effects.

Aqueous foams may also be destroyed or inhibited by the addition of certain insoluble substances that can bridge between bubbles and accelerate film thinning and breakage. As discussed in Section 5.6.7, petroleum emulsions have been used to prevent the formation of foams, or destroy foams already generated, in various industrial processes [43]. Other hydrocarbon oils, including mineral oils and vegetable oils, have also been used. In fact, the rapid spreading of drops of any low surface tension oil over foam lamellae causes them to rupture, by providing weak spots [488]. Polydimethylsiloxanes are frequently used as practical antifoaming agents because they are insoluble in aqueous media (and some oils), have very low surface tensions and are not overly volatile. They are usually formulated as emulsions for aqueous foam inhibiting so that they will readily become mixed with the aqueous

phase of the foam. Here an oil, such as a white paraffin oil, is used as a carrier. In this context, carriers act to (a) spread on the foam lamella surfaces pushing the foam-stabilizing surfactants ahead of it, and (b) carry the hydrophobic components to the surfaces [483]. In addition to the siloxanes, other hydrophobic compounds used to prevent or reduce foaming include waxes, hydrophobic silica, metal soaps, polypropylene glycols, amides and polyurethanes [483,485,489]. Ferch and Leonhardt [490] describe processes for making hydrophobic silicas.

The tests used to determine antifoaming and defoaming action are essentially the same as used for testing foaming ability (see Section 2.6.2), except that the prospective defoaming agents are added in measured amounts and in a reproducible manner.

**Example.** Commercial dish washing formulations need to be able to destroy the foam that is created by certain food soils such as the proteins from milk and milk products. A shake test can be used to determine the ability of prospective detergent formulations to defoam such food soils [123]. In this case 50 ml of diluted detergent solution that also contains 1 ml of a 10% solution of dried milk are heated to dishwashing temperature in a 250 ml stoppered measuring cylinder. The cylinder is then shaken vigorously by rapidly inverting it 10 times in 5 s, recording the foam volume immediately afterward and at 5 s thereafter. With no surfactant added, the milk proteins yield a significant foam volume. Any reduction due to the detergent addition is noted in terms of defoaming ability. (Note that many prospective detergent formulations will actually increase the foam volume.)



## 8

# Introduction to Practical and Industrial Applications

### 8.1

#### General Uses

As discussed in Chapters 1–7, diffusion, Brownian motion, sedimentation, electrophoresis, osmosis, rheology, mechanics, interfacial energetics, and optical and electrical properties are among the general physical properties and phenomena that are primarily important in colloidal systems [12,13,26,57,58]. Chemical reactivity and adsorption often play important, if not dominant, roles. Any physical chemical feature may ultimately govern a specific industrial process and determine final product characteristics, and any colloidal dispersions involved may be deemed either desirable or undesirable based on their unique physical chemical properties. Chapters 9–16 will provide some examples.

Control of colloid stability is used in a wide range of technological applications, for example [1]:

- flocculants or coagulants may be added to improve the separation of particles or droplets from a dispersion that is to be settled or centrifuged;
- paints or pharmaceuticals may be formulated so that their particles or droplets aggregate to form flocs and flocculated sediments rather than remain well dispersed and settle to form compact sediments upon standing. This makes them easier to redisperse by simple shaking or stirring prior to use;
- the compactness of thin surface coatings made by sedimentation or electrodeposition can be controlled by adjusting the stability of the suspensions from which the coatings are made; and
- the electric double layers on particles in soils can be chemically treated to control compaction, filtration, and hydraulic conductivity.

Although colloids may be undesirable components in industrial systems, particularly as waste or by-products and, in nature, in the forms of fog and mist, they are desirable in many technologically important processes such as mineral beneficiation and the preparation of ceramics, polymers, composite materials, paper, foods, textiles, photographic materials, drugs, cosmetics, and detergents. The remainder of this chapter specifies some applications for colloidal solids, liquids, and gases and illustrates how colloids can affect many technologically important systems.



Modern motor oil provides an example of some of the ways in which a number of colloidal and interfacial considerations come into play: adhesion and lubrication, detergency, dispersion and suspension stabilization, foam inhibition, and viscosity and its temperature dependence. In addition to providing lubrication, a motor oil is expected to prevent corrosion and aid engine cooling and cleaning. Table 8.1 shows how a number of additives are blended in to help the oil achieve these functions [491].

**Table 8.1** Motor oil additives. Adapted from Ref. [491].

Additive	Function
Antioxidants	prevent thickening due to oxidation when engine runs hot
Corrosion inhibitors	protect metal parts from acids and water in engine
Detergents	prevent varnish and sludge deposition on engine parts
Dispersants	keep contaminants suspended and away from engine parts
Foam inhibitors	prevent foam from being formed by crankshaft
Friction modifiers	strengthen the oil film and ensure moving parts are lubricated
Pour-point depressants	allow oil to flow in cold weather
Viscosity-index improvers	make the oil's viscosity more constant with varying temperature

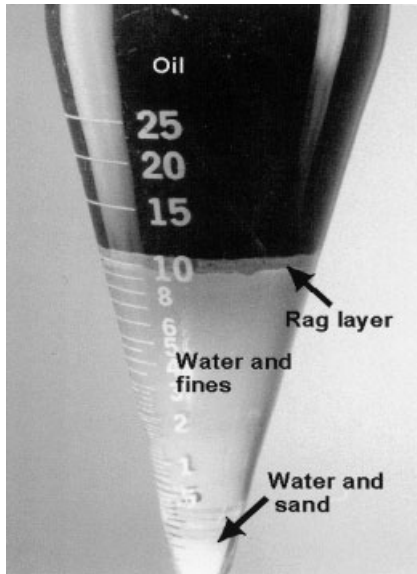
## 8.2

### Emulsions

Emulsions are commonly used in many industries. Some emulsion products (see Table 1.2) include foods, insecticides and herbicides, polishes, drugs, biological systems, paving asphalt, personal care creams and lotions, paints, lacquers, varnishes, and electrically and thermally insulating materials. Double emulsions have applications in cosmetics, agriculture, food, photography, leather, and drug-delivery (see the review in [52]). The use of emulsions to provide permanent and transient anti-foams is an application that is important to an even broader variety of products and processes, including foods, cosmetics, pharmaceuticals, pulp and paper, water treatment, and minerals beneficiation [15,28,492].

Emulsions may be encountered throughout all stages of the process industries. For example, in the petroleum industry (see Chapter 11) both desirable and undesirable emulsions permeate the entire production cycle, including emulsion drilling fluid, injected or *in situ* emulsions used in enhanced oil-recovery processes, well-head production emulsions, pipeline transportation emulsions, and refinery process emulsions [2]. Such emulsions may contain not just oil and water, but also solid particles and even gas, as occur in the large Canadian oil sands mining and processing operations [2–4].

A recurring feature in many process industries is the rag layer, mentioned earlier. A rag layer is a gel-like emulsion that forms and accumulates at the oil/water interface in a separation vessel (Figure 8.1). Rag layers tend to concentrate a range of emulsion-stabilizing components that may be hydrophilic, oleophilic, inorganic,



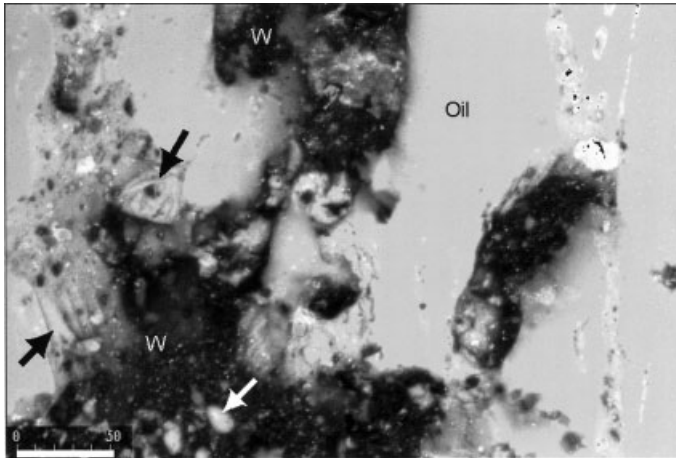
**Figure 8.1** BS&W test of an oil emulsion with a high propensity for rag layer formation. Despite the addition of toluene and the centrifugal force applied during the test a clear rag layer was formed at the oil/water interface. From Mikula and Munoz [68]. Copyright 2000, Cambridge University Press.

and organic in nature. Also, once a rag layer has formed, it can trap additional components that would otherwise have creamed or settled out of the way. This usually makes the rag emulsion even more intractable, causing them to interfere more strongly with separator performance. Rag layers can interfere with level-sensing monitors, short-out electrostatic grids, promote channelling flows, and, of course, prevent oil/water separation [452].

Rag layers can be O/W or W/O, may often contain multiple emulsions (Figure 8.2), and can even be oil- and water-continuous in different parts of the same system [68]. Rag layers present the most challenging demulsification problems. They may require all of demulsifiers, elevated temperatures, and diluents.

The occurrence of rag-layer emulsions highlights the wide-ranging importance of demulsification in many industries. Beyond the process industries, the stability of emulsions is often a problem in many other contexts. Demulsification involves two steps. First, there must be agglomeration or coagulation of droplets. Then, the agglomerated droplets must coalesce. Chemical and particulate agents that displace the surfactant and permit an unstabilized interface to form are used for this purpose. Only after these two steps can complete phase separation occur. It should be realized that either step can be rate-determining for the demulsification process. This is a large subject in its own right; see Section 7.2.1 and Refs. [2,5,37,38,493].

Many industrial and consumer products are formulated as emulsions including numerous surface coatings (Chapter 12), foods, pesticides and herbicides (Chapter 13), pharmaceutical products (Chapter 14), and personal care products such as creams and lotions (Chapter 15). Some emulsions are made to reduce viscosity so that an oil can be made to flow. Emulsions of asphalt, a semi-solid variety of bitumen dispersed in water, are formulated to be both less viscous than the original



**Figure 8.2** Confocal micrograph of a sample from the rag layer shown in Figure 9.1. The oil is the bright phase; it exhibits structures typical of gels (black arrows) which are often found in oxidized crude oil. This rag layer contained between 20 to 30% oil, which represents a significant potential loss of recovery. The water is the dark phase; it exhibits aggregates of clay particles and emulsified oil (white arrow). Bar = 50  $\mu\text{m}$ . From Mikula and Munoz [68]. Copyright 2000, Cambridge University Press.

asphalt and stable so that they can be transported and handled. In application, the emulsion should shear thin and break to form a suitable water-repelling roadway-coating material. Another example of emulsions that are formulated for lower viscosity with good stability are those made from heavy oils and intended for economic pipeline transportation over large distances. Here again the emulsions should be stable for transport but will need to be broken at the end of the pipeline.

Some special problems arise at sea. When crude oil is spilled on the ocean, a slick is formed which spreads out from the source with a rate that depends on the oil viscosity. With sufficient energy an O/W emulsion may be formed, which helps disperse oil into the water column and away from sensitive shorelines. Otherwise, the oil may pick up water to form a water-in-oil emulsion, or mousse (“chocolate mousse”). These mousse emulsions can have high water contents and have very high viscosities, with weathering they can become semi-solid and considerably more difficult to handle, very much like the rag-layer emulsions referred to above. The presence of mechanically strong films makes it hard to get demulsifiers into these emulsions, so they are hard to break. See Chapter 9.

### 8.3

#### Foams

Foams are commonplace in foods, shaving cream, fire-fighting foam, mineral flotation, and detergents [15,28,43,46,492]. Thus, in view of the fact that the concentration of bubbles greatly affects the properties of foams; the production, dispersion, and maintenance of colloidal gas bubbles are crucial to foams and related materials. Often, natural and synthetic soaps and surfactants are used to make fluid foams containing colloidal gas bubbles. These agents reduce the interfacial tension and, perhaps, the viscosity at the gas/liquid interface, making the foam stable. Also, some soluble proteins that denature upon adsorption or with agitation of the liquid phase can stabilize foams by forming insoluble, rigid layers at the gas/liquid interface [28].

Foams, in the form of froths, are intimately involved and critical to the success of many mineral-separation processes (Chapter 10). Foams may also be applied or encountered at all stages in the petroleum recovery and processing industry (oil-well drilling, reservoir injection, oil-well production and process-plant foams). A class of enhanced oil recovery process involves injecting a gas in the form of a foam. Suitable foams can be formulated for injection with air/nitrogen, natural gas, carbon dioxide, or steam [3,5]. In a thermal process, when a steam foam contacts residual crude oil, there is a tendency to condense and create W/O emulsions. Or, in a non-thermal process, the foam may emulsify the oil itself (now as an O/W emulsion) which is then drawn up into the foam structure; the oil droplets eventually penetrate the lamella surfaces, destroying the foam [3]. See Chapter 11.

Micro-foams (also termed colloidal gas aphrons) comprise a dispersion of aggregates of very small foam bubbles in aqueous solution. They can be created by dispersing gas into surfactant solution under conditions of very high shear. The concept is that, under the right conditions of turbulent wave break-up, one can create a dispersion of very small gas bubbles, each surrounded by a bi-molecular film of stabilizing surfactant molecules. Under ambient conditions the bubble diameters are typically in the range 50–300  $\mu\text{m}$ . There is some evidence that such micro-foams tend to be more stable than comparable foams that do not contain the bi-molecular film structure [111–113]. Some interesting potential applications have been reported: soil remediation [494–497] (see also Section 9.3) and reservoir oil recovery [498–500] (see also Section 11.2.2), but these are less well supported, or even conflicting within the literature.

Many consumer and industrial products are formulated as foams, including fire-fighting foams (Chapter 12), foods (Chapter 13), pharmaceutical products (Chapter 14), and personal care products such as shampoos (Chapter 15).

Not all foams are wanted though. Foams, other than flotation froths, are generally not wanted in the process industries where they tend to interfere with process unit operations and may cause upsets. Some agents will act to reduce the foam stability of a system (termed foam-breakers or defoamers) while others can prevent foam formation in the first place (foam preventatives, foam inhibitors). There are many such agents and Kerner [327] describes several hundred different formulations for foam

inhibitors and foam breakers. In all cases the cause of the reduced foam stability can be traced to changes in the nature of the interface, but the changes can be of various kinds. The addition to a foaming system of any soluble substance that can become incorporated into the interface may decrease dynamic foam stability if the substance acts in any combination of: increase surface tension, decrease surface elasticity, decrease surface viscosity or decrease surface potential. Such effects may be caused by a co-solubilization effect in the interface or by a partial or even complete replacement of the original surfactants in the interface. Some branched, reasonably high molecular mass alcohols can be used for this purpose. Not being very soluble in water they tend to be adsorbed at the gas/liquid interface, displacing foam-promoting surfactant and breaking or inhibiting foam. Alternatively, a foam can be destroyed by adding a chemical that actually reacts with the foam-promoting agent(s). Foams may also be destroyed or inhibited by the addition of certain insoluble substances such as a second liquid phase or a solid phase. Antifoaming and defoaming represent a large subject on their own (see Section 7.2.2).

Foams and emulsions may also be encountered simultaneously [114]. Figure 1.5 shows an example of an aqueous foam with oil droplets residing in its Plateau borders (see Section 5.6.7). In addition to containing gas, an aqueous phase, and an oleic phase, foams can also contain dispersed solid particles. Oil-assisted flotation of mineral particles provides one example (Chapter 10). Oil-sand flotation of bitumen provides another (Chapter 11). In the case of oil-sands flotation, an emulsion of oil dispersed in water is created and then further separated by a flotation process, the products of which are bituminous froths that may be either air (and water) dispersed in oil (from primary flotation) or air (and oil) dispersed in water (from secondary flotation). In either case, the froths must be broken and de-aerated before the bitumen can be upgraded to synthetic crude oil. (See Section 11.3.2).

#### 8.4 Suspensions

Suspensions have long been of great practical interest because of their widespread occurrence in everyday life. Suspensions have important properties that may be desirable in a natural or formulated product, or undesirable, such as an unwanted suspension in an industrial process. Some important kinds of familiar suspensions include those occurring in foods like batters, puddings, and sauces (Chapter 13), pharmaceuticals like cough syrups and laxative suspensions (Chapter 14), household and industrial products like inks, paints, and “liquid” waxes (Chapter 12) and environmental occurrences like suspended lake and river sediments, and sewage (Chapter 9).

Suspensions are created at an early stage of processes used to separate valuable minerals or oil by froth flotation (Chapter 10). Suspensions are also quite important and widespread in the petroleum industry (Chapter 11) and, like emulsions and foams, suspensions may be encountered throughout each of the stages of petroleum recovery and processing (in reservoirs, drilling fluids, production fluids, process-

plant streams and tailings ponds) as suggested in Table 11.1. In these kinds of applications it is probably the norm rather than the exception for suspensions to contain, not just solid particles and water, but also emulsified oil, and even dispersed gas bubbles.

Other applications of colloidal solids include the preparation of rigid, elastic and thixotropic gels [501–503], aerogel-based thermal insulators [502], and surface coatings [57,58,152,502]. Commercial uses of silica gel and sol-gel processing [61] often focus on rigid gels having 20–30 vol % SiO<sub>2</sub>. The principal interparticulate forces in a rigid gel are chemical and irreversible, and the colloid improves the gel's mechanical strength. Elastic gels are commonly associated with cellophane, rubber, cellulosic fibres, leather, and certain soaps. Many thixotropic gels and surface coatings contain colloidal solids, e.g., clays, alumina, ferric oxide, titania, silica, and zinc oxide. Consumer and industrial pastes belong to this category; putty, dough, lubricating grease, toothpaste, and paint are some examples.

## 8.5

### Hazards

The occurrence of some materials in the form of a colloidal dispersion can introduce or enhance safety hazards. Considering that the dispersion of a material down to colloidal size results in a high specific surface area, chemical reactivity in this state may differ considerably from that of the identical macroscopic material with less surface area.

Although the details are beyond the scope of this book, health problems can be caused by solids and liquids suspended in water (for example, in waste-tailings streams) or in air (for example, in stack-emission plumes). Specific potential hazards have been associated with a diverse spectrum of colloidal materials, including synthetic chemicals, coals, minerals, metals, pharmaceuticals, plastics, and wood pulp. Limits for human exposure for many particulate, hazardous materials are published [504,505].

Surfactants are typically used in the formulation and preparation of many dispersions, and there is a need to understand the environmental properties and risks associated with any such large volume chemical. The mass of surfactants that could ultimately be released into the environment, for example, is significant. A 1995 estimate of the global use of linear alkylbenzenesulfonates, alcohol ethoxylates, alkylphenol ethoxylates, alcohol sulfates, and alcohol ether sulfates totalled 3 million tonnes [165]. Surfactant usage in industry will probably increase as new applications are found. The toxicity and persistence of surfactants is now fairly predictable for a variety of environmental situations [164,165,506] and although surfactants are not generally viewed as a serious threat to the environment [165] they can exhibit considerable toxicity to aquatic organisms. The toxicity to arctic fresh-water biota of mineral flotation chemicals, especially xanthates, is discussed by Leduc *et al.* [507]. In addition to products, many industries produce waste containing significant amounts of suspended matter, for which treatment incurs significant technological

challenges and costs [508–510]. Trace metals that are commonly found as suspended matter in the chemical form of hydrous oxides and other insoluble matter are tabulated elsewhere [504,505]. Large fractions of readily hydrolyzable metals exist as adsorbed species on suspended (colloidal) solids in fresh and marine water systems and can also be anticipated in industrial wastewater. Continued research is needed to understand the health hazards linked to colloidal pollutants.

Emulsions, foams, and suspensions can pose hazards in certain circumstances. An emulsion example is represented by the O/W mousse emulsions that can be formed following marine oil spills can pose a serious hazard to wildlife (see Section 9.5). A foam example is represented by the past practice of dumping used drilling-fluid foams into open disposal pits (see Section 11.1). These foams, which are typically formed from nitrogen rather than air, do not provide a human-friendly atmosphere and workers have been known to enter these pits and die from asphyxiation. Finally, a suspension example. Suspensions of charged colloidal particles in non-aqueous media occur throughout the petroleum industry. Here, the low conductivity of petroleum fluids, which allows the build-up of large potential gradients, combined with the flow of petroleum fluids in tanks or pipelines can cause a separation of charges. Sufficient charging for there to be an electrostatic discharge can cause an explosion [279].

## 9

### Applications in the Environment

#### 9.1

##### Introduction

Suspensions, and to some degree emulsions and foams, play crucial roles in the evolution of the earth's rocks, rivers, streams, lakes, oceans, and soils. Table 9.1 lists some examples. In many cases their role is somewhat disguised in that these colloidal dispersions are the precursors to the ultimate products, the latter having very different final appearances, such as many rocks, sediments, and soils.

**Table 9.1** Some emulsions, foams, and suspensions in the environment\*.

Emulsions	Insecticide and herbicide formulations	O/W
	Water and sewage treatment emulsions	O/W
	Oil spill emulsions	W/O, O/W
Foams	Sulfide liquids in magma or lava	L/L
	Free gas bubbles in oceans, lakes and rivers	G/W
	Foams on polluted lakes and rivers	G/W
Suspensions	Volatiles (water, CO <sub>2</sub> ) in magma or lava	G/L
	Suspended soils and sediments	S/W
	Muds, quicksand	S/W
	Rock fragments in lava	S/L
	Solid silicates in magma	S/L
	Solid particles in rain drops	S/W
	Sediment particles in oceans, lakes, rivers	S/W

\* Dispersion abbreviations include liquid (L), water (W), oil (O), gas (G), and solids (S).

#### 9.2

##### Rocks, Sediments, and Soils

Within the earth are hot, fluid precursors to lava, called magmas. These magmas can contain hot liquids, gases, and solids in all proportions and combinations, and they have an extremely variable rheology [511,512]. As such, magmas can represent



emulsions, foams, suspensions, or any combination of these dispersions. Each of these kinds of dispersions can also be found in lavas [49] (see Table 9.1). For example, when pressure is released during the upward flow of obsidian lava, a foam is formed. If the foamed lava cools without breaking, the result is pumice (stone) [511].

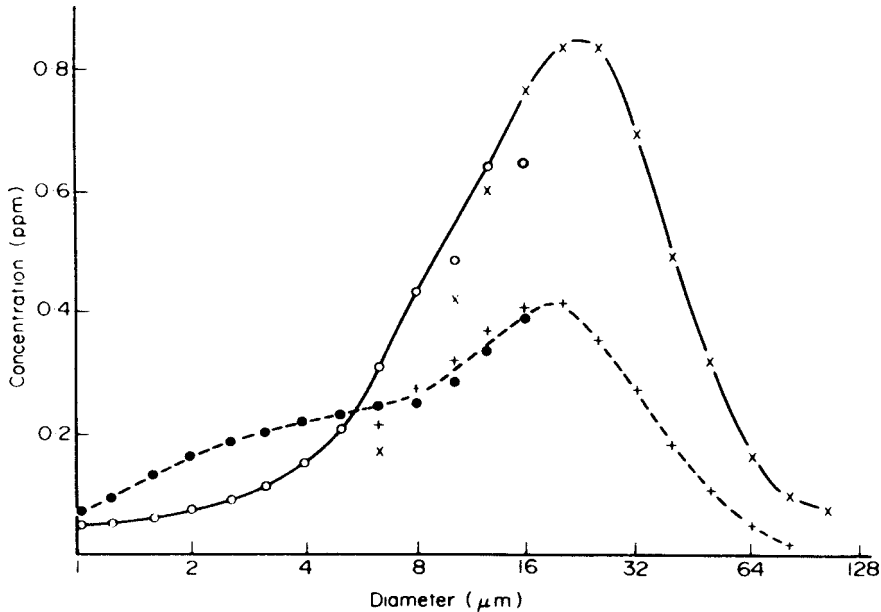
At the surface of the earth there exist countless examples of suspensions, including the suspended mineral and humic matter particles carried by streams and rivers, and found in lakes and oceans [513,514]. The sediments formed from these suspensions, once the voids are filled in and cemented in place by other minerals, become sedimentary rocks such as sandstone [515]. The particles that are picked up and carried along by streams and rivers, maintained in suspension by turbulence, are called suspended load. Lakes and oceans can be considered to be huge colloidal suspensions, typically containing 0.5–1.5 mg/l of suspended fine solids. The near-colloidal sized fraction, particles of up to about 0.1  $\mu\text{m}$  in diameter, may be able to remain in suspension for considerable periods of time, even in quiescent waters. This fraction is called the wash load [515]. Table 9.2 shows the terminal sedimentation velocities of sand, silt, and clay particles in seawater [516]. It can be seen, that while the sand particles are likely to settle out near their point of entrance to the ocean, the clay particles could, in principle, be transported almost anywhere in the world before sedimenting out. In addition to being suspensions, oceans can also comprise foam systems where they contain free gas bubbles (which can result from volcanic gases or the decomposition of organic matter).

**Table 9.2** Some terminal sedimentation velocities for particles in seawater\* (from [516]).

Particle type	Diameter ( $\mu\text{m}$ )	Sedimentation velocity (cm/s)	Time to sediment 4 km
Sand	100	2.5	1.8 days
Silt	10	0.025	185 days
Clay	1	0.00025	51 years

The suspension, transportation, and deposition of particles in lakes, rivers, and oceans clearly involves an interplay of the principles of colloidal stability and hydrodynamics. The background for this was discussed in Chapter 2. Figure 2.12 shows the sedimentation rates for different sizes of quartz grains in water, while Figure 2.13 illustrates the flow regimes corresponding to erosion, transportation and deposition. When the variations in stability against aggregation and flocculation are taken into account, the results can become quite complex [49,315].

The main cause of sedimentation of particles in estuarine environments is aggregation [49]. Later, when the flocs settle out they lose their identity and become part of the bottom sediment [49]. Therefore, when analyzing sediments, it is not a simple task to relate the size distribution in the sediment to the sizes, transport mechanisms, and behaviour of the particles before they were deposited. These waters tend to exhibit quite broad size distribution curves, although, if samples are collected and deflocculated, even flatter, broader distribution curves result, having smaller mode



**Figure 9.1** Example of typical grain-size spectra of suspended particulate matter from coastal waters with high inorganic content. The solid curves show the natural flocculated particle distributions and the broken curves show the deflocculated inorganic grains. From Yariv and Cross [49]. Copyright 1979, Springer-Verlag: Berlin.

size (Figure 9.1). The impact of selective flocculation and consequent settling can be seen in the deposition of montmorillonite versus illite clays in the oceans. Montmorillonite tends to be deposited near the mouths of rivers whereas illite tends to be carried a greater distance before being deposited [49]. The clay minerals, together with zeolites and some hydrated metal oxides and hydroxides, constitute a wide range of suspensions found in sediments and soils [49].

One source of natural soils is the sediments from rivers, lakes or oceans that have receded. As bi-continuous systems of water and solids, soils are beyond the scope of this book. However, a few linking comments will be offered. Soil colloids include clays, (hydr)oxides (that is, oxides and hydrated oxides) of iron, manganese, and aluminum, and soil organic matter, among others [444,514,517,518]. Soil organic matter comes from living or dead organisms and is usually divided into two categories, humic and non-humic substances. Humic substances are high molar mass compounds that are formed in the soil and are quite different from the components of plants and higher organisms [519]. Humic substances are operationally defined in terms of solubility and subdivided into humic acids, fulvic acids, and humin. One example of the action of humic substances in natural waters and soils is their adsorption onto mineral solids, conferring both electrostatic and steric stabilization mechanisms. Non-humic substances are simpler organic compounds such as polysaccharides, proteins, fats, waxes, lignin and resins [519]. The complexity of these

systems means that the application of thermodynamics to soils will provide only approximations since gas, liquid and solid phases are almost never homogeneous or in equilibrium [514]. Also, a very wide range of reaction time-scales occur in soil systems, from microseconds for ion association reactions, to milliseconds for ion exchange and adsorption reactions, to years for many mineral solution and mineral crystallization reactions [520].

Soil management involves maintaining such properties as workability, drainage, and root growth, which are functions of porosity and permeability. The type and amount of clay minerals in a soil also influence, through their surface properties, these properties as well as structural stability [521]. Thus, the soil needs to be maintained in a state of flocculation rather than peptization since the latter leads to compaction, with reduced drainage, workability, and root penetration. Peptization of solid particles is most often caused by heavy rains, whereas flocculation is promoted by any of flooding by seawater, addition of salts (e.g., gypsum or lime), or the addition of soil conditioners (e.g., organic polyelectrolytes). The soil conditioners become strongly adsorbed and tend to be less easily washed out of the soil than are simple electrolytes such as gypsum. With a range of mineral types present in a hydrated soil, a complex interplay among the electrostatic forces due to these minerals, respective charged surfaces, determines such soil properties as shrinking and swelling, and to some degree soil structure, shear strength, and Atterberg limits (soil-flow characteristics) [521,522].

### 9.3

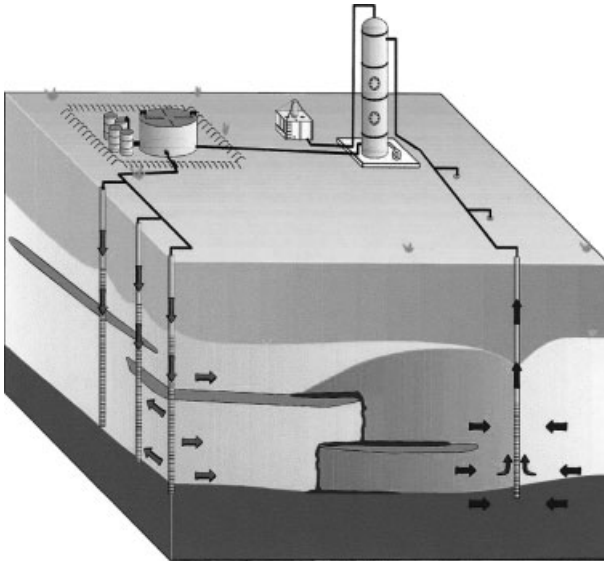
#### **Environmental Soil Remediation**

The contamination of ground water by non-aqueous phase liquids (NAPLs) is a cause for concern throughout the world. Examples include gasoline, aviation, and other fuels. Dense non-aqueous phase liquids (DNAPLs) have densities greater than that of water so that they tend to migrate downward through an aquifer under the force of gravity and stop when used up as residual saturation in pores along the way, or else when they can no longer penetrate into pores [523]. These can easily become too deep for classical remediation technologies, such as excavation. Some DNAPLs include tetrachloroethylene (PCE), trichloroethylene (TCE), 1,1,1-trichloroethane (TCA), creosote, and polychlorinated biphenyls (PCBs). These DNAPLs can easily invade the subsurface, are difficult to remove, have sufficiently high solubilities to be of concern with respect to drinking water standards, and have low biodegradability [524]. Overall, NAPLs can persist in the soil for many decades and present a long-term threat to groundwater quality [525]. The use of surfactants to remediate ground water contaminated by non-aqueous phase liquids has been under significant development and field testing over the past two decades, especially for the difficult-to-remediate DNALSs such as chlorinated solvents [526–528].

The techniques used to achieve the displacement, solubilization, and flushing of the NAPLs are adapted from the same principles (see Section 11.2.2) that are used for displacing trapped crude oil from pores in reservoir rock via surfactant-based

enhanced oil recovery technology [234,529,530]. This may include beginning with a water flood to remove any easily recoverable mobile DNAPL, then following with an *in situ* surfactant flood to displace the more tightly held, residual DNAPL. An illustration is provided in Figure 9.2. Field testing has demonstrated that surfactant flooding can remove tetrachloroethylene rapidly and more than twenty times more effectively than water flooding [523]. The *in situ* surfactant flood may involve microemulsion formation [531], the possibility of altering the wettability of the soil (see also Sections 3.5.3 and 11.2.2), and the use of foams for mobility control [532]. The surfactant selection criteria are also very similar [527]. The adaptation of surfactant flooding to soil washing has now become an accepted practice in many countries [226].

New surfactants can be tailored to meet specific goals, such as improving their microemulsion-forming ability for specific situations by changing the numbers of ethylene oxide or propylene oxide units in the surfactant [533–535]. Kimball [536] has applied this technology and found that surfactants were effective at removing hexadecane, o-cresol and phenanthrene by changing the surface wetting state and desorbing the contaminants during flushing of the soil. In addition to the solubilization and removal of the contaminated oil, the surfactants employed may improve the wettability of the soil particles, which is an advantage should additional soil washing be needed [226]. With a good surfactant formulation based upon good phase behaviour, up to 99.9% of the NAPL can be recovered from a soil column in as little as 1.0–2.0 pore volumes of surfactant flooding [527]. A major constraint for such processes is that surfactants, if left behind, must not impose an environmental



**Figure 9.2** Illustration of an *in situ* surfactant flood for the displacement and production of DNAPL contaminants from a contaminated subsurface zone. From Battelle [538]. Copyright 2002, Naval Facilities Engineering Command.

threat [537]. A relatively recent field demonstration of this technology showed that the DNAPLs can be removed from the produced surfactant solution, at the surface, enabling the surfactant to be re-injected [528].

Several successful field demonstrations of *in situ* surfactant flooding for NAPL soil remediation have been conducted [523,526,528,530,538,539] and design and implementation manuals are available [538–540].

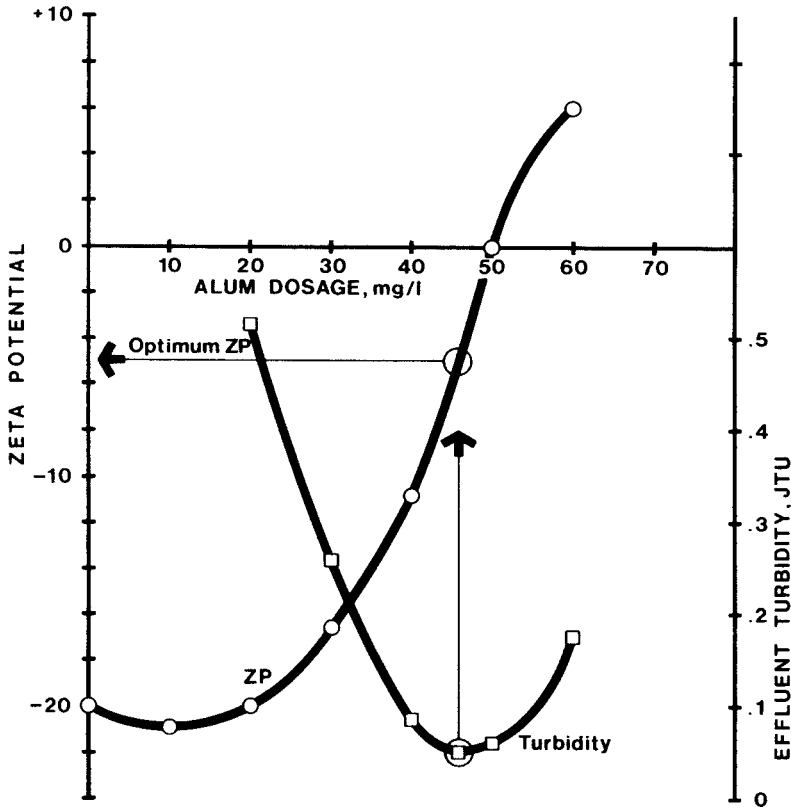
Micro-foam, or colloidal gas aphrons have also been reportedly used for soil flushing in contaminated-site remediation [494–498]. These also have been adapted from processes developed for enhanced oil recovery (see Section 11.2.2.2). A recent review of surfactant-enhanced soil remediation [530] lists various classes of biosurfactants, some of which have been used in enhanced oil recovery, and discusses their performance on removing different type of hydrocarbons, as well as the removal of metal contaminants such as copper and zinc. In the latter area, the application of heavy metal ion complexing surfactants to remediation of landfill and mine leachate, is showing promise [541].

#### 9.4

#### Water and Wastewater Treatment

Water and wastewater treatment inevitably involve the removal of suspended solids (often referred to as turbidity), usually silt, clay, hydrous oxides and organic matter. Of these, the most difficult suspended solids to remove are the colloidal-sized fraction which, because of their small size, can easily escape both sedimentation and filtration. Examples of these would include: spent protein and emulsions from domestic waters, bacterial cells, algae, viruses, amoeba, industrial waste colloids, silts, clays, and organic matter from soil wash. The charge on the suspended solids is often sufficiently negative to yield a stable dispersion that settles slowly and is difficult to filter. In this case the key to effective colloid removal by sedimentation is reduction of the zeta potential to zero, or near-zero. Once the charge is reduced or eliminated, electrostatic repulsive forces are minimized. The gentle agitation of the flocculation basin then causes numerous colloid collisions, first with formation of microflocs and then with visible floc particles which can easily be settled or filtered. Coagulants such as alum, ferric chloride, or cationic polymers all function primarily as “charge reducers” [513,542].

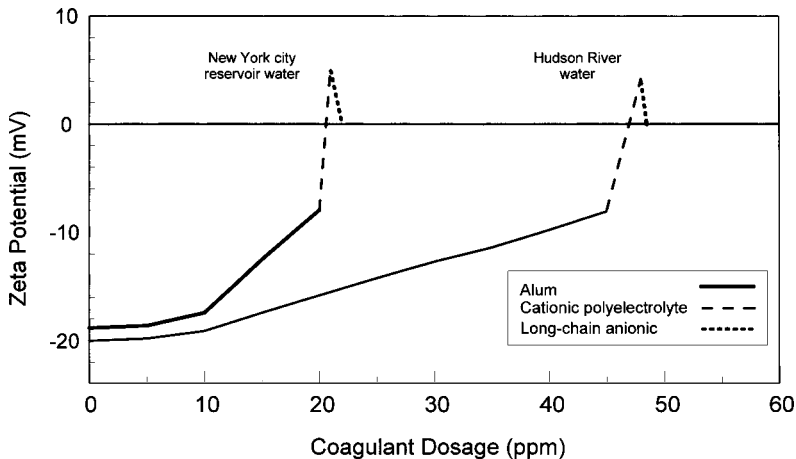
In water treatment, for example, a common goal is to reduce the zeta potential of the particles to low values (about  $-3$  to  $-5$  mV) that permit rapid coagulation, increasing both sedimentation and filterability [543]. A first step towards coagulating the suspension might be to add aluminum sulfate (alum) or iron (III) chloride. In either case the trivalent metal cations will have a powerful effect on the zeta potential (see the Schulze–Hardy rule, Section 5.2.3). Figure 9.3 shows an example of this effect [544]. In practice, however, the alum required to reduce the zeta potential to below about  $-10$  mV or so may reduce the solution pH too much (unreacted alum becomes carried to other parts of the plant and forms undesirable precipitates). So alum might be added to bring the zeta potential down to only about  $-10$  mV as



**Figure 9.3** Illustration of Zeta potentials and turbidity (coagulation/removal of solids) in a raw water sample, by adding aluminum sulfate (alum). From Zeta-Meter [544]. Courtesy L.A. Ravina, Zeta-Meter, Inc., Staunton, Va.

a first step. As shown in Figure 9.4, a second step can then be introduced in which a cationic polyelectrolyte is added to reduce the zeta potential to a near-zero value (slightly positive in the example in Figure 9.4) but without changing the pH [544]. As a final step a high molecular weight anionic polymer may be added (MW 500 000–1 000 000 or more) whose molecules can bridge between agglomerates yielding very large, rapid settling flocs. Figure 9.4 shows how two New York water samples were treated in this way [545,546]. Illustrations of drinking water and wastewater treatment plant processes are given in references [542,547,548]. Numerous examples of the kinds of settling tanks that can be used are given in Ref. [543].

An alternative to sedimentation for removing suspended solids is flotation. This tends to be used for low-density particles that tend to float anyway during conventional sedimentation processes. Drinking water examples include algae and flocs of humic and fulvic acids that result from the treatment of coloured waters [549]. Wastewater examples include fatty materials, pulp fibres, and oils that can be floated



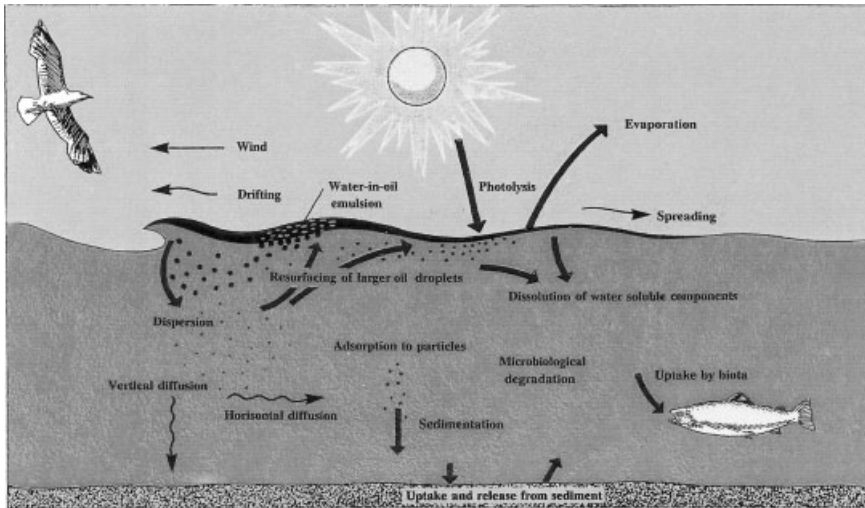
**Figure 9.4** Illustration of Zeta potentials and coagulation of solids in New York City water treatment through sequential additions of aluminum sulfate (alum), cationic polyelectrolyte, and anionic polymer. Adapted from Zeta-Meter [544]. Courtesy L.A. Ravina, Zeta-Meter, Inc., Staunton, Va.

[543,550,551]. Two kinds of flotation have been commonly used in wastewater treatment, electrolytic flotation and dissolved air flotation [543,549]. In electrolytic flotation very small bubbles ( $\sim 40 \mu\text{m}$  diameter) are generated by the electrolysis of water. The small bubbles make it possible to float small particles, very much as is described in Section 10.3 for separating mineral particles from each other. In dissolved air flotation the principle is the same except that air is introduced into flotation cells by applying a vacuum to a wastewater saturated with air, or by dissolving air in the water under pressure and then releasing the pressure to free the air as fine bubbles. In dissolved air flotation the bubble sizes are larger ( $\sim 20\text{--}100 \mu\text{m}$  diameter) than for electrolytic flotation. In both kinds of water treatment the surfaces of the contaminants to be floated are generally hydrophilic enough that these flotation processes can be operated without the addition of flotation reagents such as collectors or frothers [549,550]. The kinds of flotation cells used in these applications are described elsewhere [53,91,549].

## 9.5

### Spills and Other Hazards

Marine oil spills can cause significant environmental damage. When a crude oil is spilled at sea several processes can occur (Figure 9.5) [552]. Immediately following a spill, a slick is formed which spreads out from the source [553,554]. Studies of the spreading of the spilled oil have been carried out by a number of researchers [553,555–561]. Next there is the potential for the formation of two quite different kinds of emulsions.



**Figure 9.5** Illustration of processes involved when oil is spilled on the sea. From Daling and Brandvik [552]. Courtesy T. Strøm-Kristiansen, IKU Petroleum Research, Norway.

In addition to drifting and evaporation, wind and wave energy advection and turbulence can cause an O/W emulsion to be formed which helps disperse oil into the water column and away from sensitive shorelines [562,563]. These droplets typically become weathered, accumulate suspended fine solids, and settle out [564–567]. For this reason oil-spill response teams may actually promote the formation of O/W emulsions from oil in the slick.

For the fraction of the oil that does not disperse in this manner the oil may pick up fine water drops (about 1–10  $\mu\text{m}$  in diameter) to form a W/O emulsion. These emulsions can have high water contents (as much as 74% or more, without inverting) [566]. Such high water content emulsions tend to be quite stable and increase the quantity of pollutant. With increasing water content the emulsion becomes brown to light brown in colour, leading to the term mousse emulsion (or “chocolate mousse” emulsion) [554]. With increasing water content the viscosity of the emulsion also increases (see Section 6.5), so mousse emulsions are usually much more viscous than the oil itself. With additional weathering they can become semi-solid. The emulsified water drops appear to be stabilized by asphaltenes, natural surfactants, and waxes surrounding the water droplets, which create a combination of steric stabilization and mechanically strong, visco-elastic films [568–577]. Their remarkable stability together with weather and sea conditions, makes it difficult to use dispersants and/or demulsifiers effectively on this kind of emulsion [553,578,579].

The steps involved in the clean-up of an oil spill may involve any or all of containment, mechanical removal, shoreline cleanup, *in situ* burning, and dispersal. Dispersal is usually aimed at creating an O/W emulsion so that the dispersed oil drops can settle out as described above. Emulsification of the oil also accelerates microbial deg-



radation of the oil due to its increased surface area. To achieve O/W emulsification the dispersant (emulsifying agent) needs to be added within about the first 12–24 hours after a spill, otherwise a maximum viscosity mousse emulsion will have formed making it extremely difficult to get the dispersant into the oil [578,580]. Nevertheless dispersants are used in oil-spill treatment.

A fairly large number of demulsifying/dispersing formulations have been created for application to marine oil spills [553,581–583]. They are usually designed to promote oil-in-water emulsion formation, and tend to be moderately hydrophilic. Many such formulations are mixtures of non-ionic and anionic surfactants, formulated to achieve a target HLB of about 10 [581,583–586]. They are usually formulated in a solvent that will be miscible with the spilled oil [587]. Determining the effectiveness of a chemical agent is a complex issue because it is a function of the oil type, composition, the amount of oil present and how long it has weathered. A review of laboratory testing methods is given by Clayton *et al.* [78]. Oil-spill dispersants are usually applied from boats, aircraft, or helicopters [553,579]. The dispersant application is also influenced by factors such as oil-spill slick thickness, degree of oil weathering that has already taken place, and the prevailing weather and sea conditions [578,579]. For these reasons oil-spill dispersion has, in practice, met with mixed success. Some reviews of field trials are available [578,579].

Spills of the bituminous fuel Orimulsion<sup>®</sup> are somewhat different from conventional oil spills because this material is an O/W emulsion to begin with (see Section 11.3.1). Therefore, instead of forming a slick and floating on the surface, these spills tend to immediately disperse into the water [588]. When Orimulsion<sup>®</sup> is spilled in freshwater, the bitumen from the emulsion tends to sink to the bottom, whereas when spilled in seawater it tends to rise to the surface [588].

## 9.6

### Environmental Foam Blankets

Several kinds of foams have been developed for use as temporary blankets to cover sanitary landfill sites. The foam acts to suppress the release of emissions and odours (especially volatile organic compounds and carbon dioxide) and prevents erosion and distribution of landfill particulates by wind. As additional layers of landfill material are eventually added, the foam collapses without occupying the volume that would otherwise be taken up by conventional soil covers (a significant issue considering the typical soil layer depth of 15 cm and the large number of layers involved in a mature landfill operation) [589–592]. The foam blankets also serve to repel pests, including birds, scavenging animals, and insects, and may even incorporate specific pest-aversion agents, such as acetophenones, into the foam formulation [592].

Similar applications of foam blankets have been developed for:

- emission and odour-suppressing covers for use during the remediation of contaminated soils, particularly those containing volatile organic compounds [593];

- dust-suppressing covers for use on mine tailings piles [592];
- emission-suppressing covers for hazardous waste sites [594];
- blast noise and pressure wave suppression blankets to minimize otherwise dangerous sound and damage impacts of explosions [595–597];
- flammable vapour suppression, to prevent evaporation, oxidization, and/or ignition, for petroleum products during the loading of oil tankers or storage tanks, and for spills [598];
- herbicidal blankets for sewer pipes and other conduits, to provide a sustained foam coating containing a herbicide, such as a dithiocarbamate, that can be applied to the roof and upper portions of such conduits to kill plant and tree roots as they enter [599,600];
- pesticidal blankets for troublesome insects such as termites, to provide a sustained foam coating containing a pesticide, such as a pyrethroid, that can be applied to fill and block entrances to buildings and other structures to be protected, and that will kill the pests [601,602]; and
- neutralizing and confining blankets for toxic chemical and biological warfare or terror agents such as anthrax, VX, and sarin nerve gas. The foams are formulated with detergents and oxidizing agents to displace and deactivate the toxins [603–605]. See also Section 16.3.

Where the vapours to be controlled are flammable, many of these foams are quite similar to the protein, fluoroprotein, and aqueous-film-forming foams used in fire-fighting [590,594,598] (see also Section 12.9). Where longer-term odour and toxicity control are more important many of these foams are polymer-thickened and gelling foams [592–594]. Other applications of foam blankets are discussed in Sections 10.5 and 13.



## 10 Mining and Mineral Processing Applications

### 10.1

#### Introduction

Many of the applications of colloid and interface science to the mining and mineral processing industry can be found in the hydrotransport, flotation, and tailings processes. Although suspensions feature prominently in each of these, a range of emulsions, foams and suspensions can be found in this industry. Some examples are given in Table 10.1.

**Table 10.1** Some emulsions, foams, and suspensions in mineral processing\*.

Emulsions	Emulsion-flotation media	O/W
	Oil-flotation froth	O/W
Foams	Mineral-flotation froths	G/W
	Oil-flotation and oil-assisted froths	G/O and G/W
Suspensions	Mineral-process slurries (pulpes)	S/W
	Mineral-flotation froths	S/W
	Oil-flotation and oil-assisted froths	S/W and S/O
	Mineral-tailings slurries and ponds	S/W

\* Dispersion abbreviations include water (W), oil (O), gas (G), and solids (S).

### 10.2

#### Hydraulic Mining and Hydrotransport

Hydraulic slurry transport, by pipeline or by open channels (flumes), is used for long-distance transportation of mined minerals, such as coal, iron, copper, lead, and zinc ores, phosphate ores, and for other materials, such as mineral recovery process tailings [606,607] or sediments dredged from the bottoms of lakes and rivers [608]. Where pipelines are used, they can be hundreds of kilometres in length and may be above ground, buried underground, or submarine. One of the oldest and longest is the Black Mesa coal slurry pipeline (Arizona, USA), which is 440 km long and has been in operation since 1970 [607,609].

In some cases the mining operations involve hydraulic mining: the use of a water jet to dislodge and move mineral particles from the original deposit and create a suspension (this has been applied to a range of ores, from placer gold [610] to coal [611]). In other cases the mineral particles are mechanically mined and separately slurried, such as in some coal, copper [11], and oil-sand [612] mining operations. Although the suspensions usually involve particles dispersed in an aqueous solution, the continuous phase is sometimes oil, such as in the case of coal-oil suspensions that are used for combustion as an alternative to heavy fuel oil.

The main reason for using a pipeline is usually to minimize the cost of transportation. Where water resources are limited this can mean designing a pipeline to operate at the maximum possible solids concentration [606,613]. Pipelined coal suspensions have ranged from 40–60 mass % solids, the latter representing a saving of about 30% in water use compared with the former [613]. Many mineral-ores-concentrate pipelines involve slurry concentrations of 60–70 mass % [607]. However, there is a limit to the cost-savings that can be realized by increasing suspension concentration since, beyond a certain concentration, the water-use savings are offset by increasing frictional head-loss in the pipeline which leads to a requirement for larger pumps and increased energy input.

Some of the key variables involved in slurry pipeline design and operation include:

- particle-size distribution and concentration;
- continuous-phase nature (water or oil) and composition;
- pipe diameter, which can be as large as 1 m, and pipeline angle(s) with respect to the horizontal;
- pump size and type; and
- flow rate.

A reasonable degree of stability on the part of the suspensions to be transported is important so that the solid particles do not settle out in the bottom of the pipeline during transport, or even during brief periods of stoppage. If they do settle out then the settled-bed characteristics have to be such that the pipeline can be restarted after a shut-down. Some of the suspensions pipelined contain a significant enough fraction of fine particles for electrostatic repulsions, and DLVO theory, to be important to the overall stability. In such cases, the zeta potential has been used to monitor and adjust suspension stability, and thereby minimize the pumping power expended [614]. This applies to the laminar flow regime. In some cases, long-distance pipelines, such as some fine limestone particles, are operated continuously in laminar flow mode [607]. The colloidal stability of suspensions is much less important under turbulent flow conditions, which can handle coarser particle suspensions and can also break up aggregates as they form (note that stability against sedimentation is still important in turbulent flow). The presence of gelling clays in a mineral slurry can place severe limits on the maximum allowable shut-down time for a pipeline [607].

The flow rate in a transportation pipeline has to be larger than the deposition velocity of the mineral particles in order to avoid solids segregation. Typical flow rates

range from 1–2 m/s for coal and oil sand froth pipelining, to about 4 m/s for some heavy metal concentrates [607]. For mineral slurries, abrasion becomes a significant concern at velocities above about 2.5 m/s and a major problem above about 4.5 m/s [607].

The rheological properties of the suspensions are obviously important since they have a direct bearing on the pumping power that is needed. It is also crucial to know whether or not the suspension has a yield stress, and how large it is, since this can overload pumping capabilities and prevent a pipeline from being restarted following a shut-down. The particle-size distribution is important, not just with regard to its influence on rheology and suspension stability, but also with regard to abrasion and wear of the pipeline itself.

Metal ore bodies may contain several different minerals that are separated into individual concentrates. These may be slurry-transported in the same pipeline by pumping them in separate batches, each separated by a slug of water to prevent contamination [607]. Such batching also allows pipeline flow to be maintained when the mine or separation site temporarily runs out of ore.

For reviews and more information on the principles and practice of mineral-slurry pipelining see Refs. [90,615–618]. The relationships among suspension rheology, flow rate, and pressure drop in a pipeline are discussed in Section 6.7.1; and oil pipelining is discussed in Section 11.3.4.

### 10.3

#### Mineral Flotation

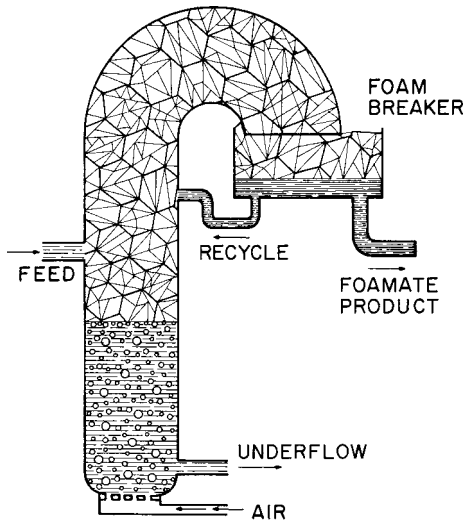
The raw minerals mined from natural deposits comprise mixtures of different specific minerals. An early step in mineral processing is to use crushing and grinding to free these various minerals from each other. In addition, these same processes may be used to reduce the mineral particle sizes to make them suitable for a subsequent separation process. Non-ferrous metals such as copper, lead, zinc, nickel, cobalt, molybdenum, mercury, and antimony are typically produced from mineral ores containing these metals as sulfides (and sometimes as oxides, carbonates, or sulfates) [91,619,620]. The respective metal sulfides are usually separated from the raw ores by flotation. Flotation processes are also used to concentrate non-metallic minerals used in other industries, such as calcium fluoride, barium sulfate, sodium and potassium chlorides, sulfur, coal, phosphates, alumina, silicates, and clays [91,619,621]. Other examples are listed in Table 10.2, including the recovery of ink in paper recycling (which is discussed in Section 12.5.2), the recovery of bitumen from oil sands (which is discussed further in Section 11.3.2), and the removal of particulates and bacteria in water and wastewater treatment (which is discussed further in Section 9.4).

**Table 10.2** Some applications of flotation separation.

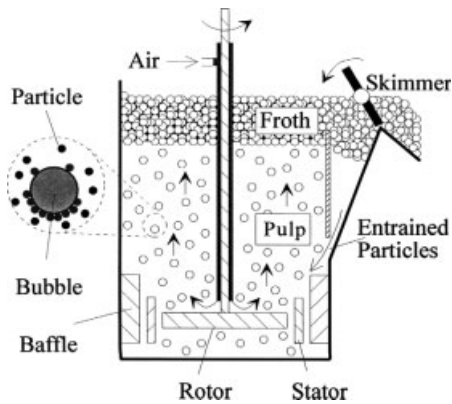
Species recovered	Recovered from	Industrial process or interest
Non-ferrous metal sulfides (Cu, Pb, Zn, Ni, Co, Mo, Hg, Sb)	Mineral ores	Metal production
Potassium chloride	Potash	Fertilizer
Coal fines	Ash-producing shales and rocks, and SO <sub>2</sub> emission-producing metal sulfides	Electric power
Ink particles	Waste paper	Paper recycling
Silver	Photographic materials	Recycling
Copper	Acid mine effluents	Metal production
Bitumen	Oil sands	Petroleum industry

Mineral flotation is discussed in a number of reference books [53,91,447,622,623,625]. The principal kinds of industrial-scale flotation are froth flotation (turbulent conditions) and film, column, or other low-shear flotation. The latter will be briefly introduced first. In film flotation a dry mixture of particles is placed onto a free liquid surface (normally this is an aqueous surface). Lyophilic particles will quickly become wetted by the liquid and will sediment down, thus separating them from the lyophobic particles which will continue to float on the liquid surface. The floating particles can then be skimmed off and collected. Compared with froth flotation, film flotation requires a large free liquid surface. Another example of low-shear flotation involves foam separation using low flow rates, such as column flotation, with subsequent foam breaking and recovery of the floated materials [266]. Column flotation has been applied to the cleaning of a variety of heavy metal ores including molybdenum [624]. In low-shear flotation, the foam breaking may involve any combination of thermal, mechanical, or chemical methods. An illustration is provided in Figure 10.1. This kind of apparatus can also be used for foam fractionation, in which soluble, surface-active species are selectively concentrated in the foam and recovered.

Froth flotation is an application of foams that is used to separate mineral components from each other based on their having different surface properties, typically their wettability and surface electrical charge. For example, froth flotation is the classic process used to separate copper from lead ore. The process involves having hydrophobic particles attach to gas bubbles which rise through a turbulent suspension to create a surface foam called a froth. Figure 10.2 shows an illustration of a mechanical flotation cell. This is the classic flotation device [53,91,625]. First, the flotation feed particles are well dispersed into a particle suspension. Together with chemical flotation aids, such as collectors and frothers, this constitutes what is called the flotation pulp. In a mechanical flotation cell, air is fed in the form of fine bubbles and introduced near the impeller (see Figure 10.2). In addition to mechanical flotation cells, there are also pneumatic cells and cyclone flotation cells. Pneumatic



**Figure 10.1** Illustration of a low-shear type flotation cell. From Somasundaran [266]. Copyright 1975, American Institute of Chemical Engineers.



**Figure 10.2** Illustration of an agitation type flotation cell. From Nguyen and Schulze [53]. Copyright 2004, Dekker.

cells introduce compressed air into the flotation cell and deposit the pulp feed on top of the froth layer [53,91,625]. Such cells are well suited to larger-sized particles. Cyclone cells introduce the pulp feed and air together, through a cyclone feeder, into the flotation cell [91,625]. This causes a very thorough contacting of particles and bubbles. In any of the three flotation-cell types the bubbles collide with the various particles and attach to those that are sufficiently hydrophobic. If the particles are small enough then the particle-bubble aggregates rise (cream) to the surface where they form a froth. The froth is removed by skimming, producing a concentrate of



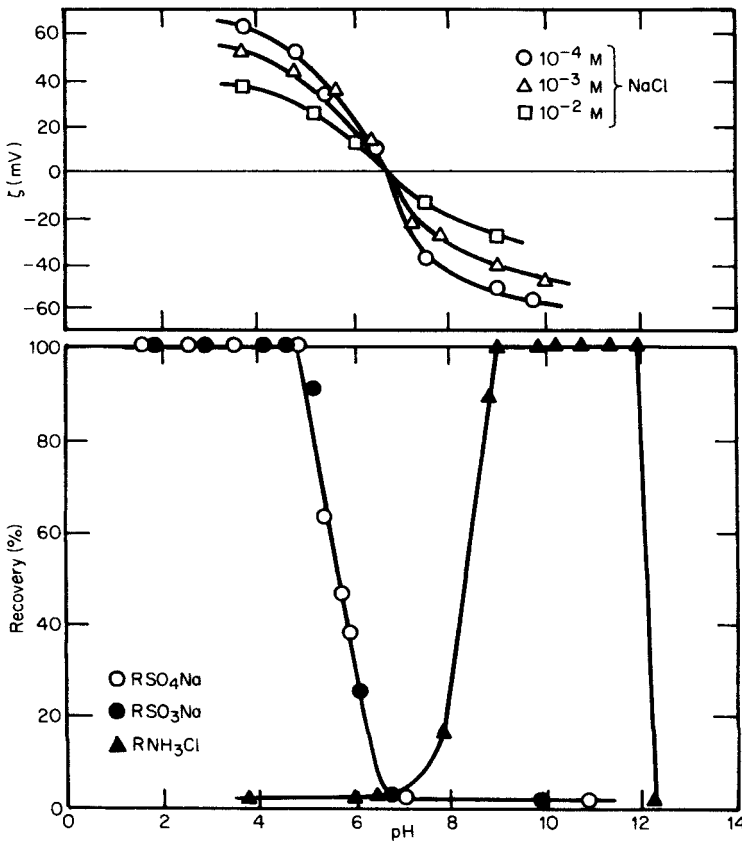
the hydrophobic particles. The hydrophilic particles, that are not floated (gangue), remain in the pulp and are drained from the flotation cell as tailings. Some of the advantages of froth flotation include its applicability to quite small particle sizes, its ability to be fine-tuned to make it selective for some solids over others, the purity of the froths produced, and the relative space (volume) efficiency of flotation cells as opposed to, for example, gravity separators.

One of the first steps in ore preparation is crushing and grinding to free (liberate) the valuable minerals from each other and also from the undesired minerals (gangue). The grinding operation is often carried out in two stages. A roll mill may be employed first, followed by screening to remove coarse, unwanted mineral particles. Next a ball mill, and possibly a size-separation device such as a hydrocyclone, may be employed to reduce the particle-size range to values suitable for the flotation process [53,91,620]. Hydrocycloning provides a means to separate out the fine particles (slimes) that would be slow to float, tend to consume an inordinate amount of flotation reagents, and which may interfere with selective flotation stages.

As stated above, flotation takes advantage of differences in surface properties among different particle types. Coal may need to be cleaned of associated mineral matter if it is to be used for making coke, or cleaned of associated inorganic sulfur compounds if it is to be burned [626]. The flotation separation of clean coal is accomplished with only the need to add a frothing agent, such as methyl isobutyl carbinol (MIBC), to stabilize the foam (see below). The lighter, clean coal particles naturally attach to the air bubbles and are carried up into the froth [626]. Other minerals that can attach to air bubbles and be floated, based on their naturally hydrophobic surfaces, include talc, pyrophyllite, sulfur, stibnite, molybdenite, and graphite [621,627,628]. Although the flotation of hydrophobic minerals does not usually need process-reagent additions, collectors and frothers (see below) may be used to improve flotation efficiency [621].

One does not have to rely, however, on the natural surface properties of desired, or undesired, particles. One of the main classes of flotation-aid chemicals is called collectors. These are surfactants that will adsorb onto the surfaces of the desired particles, with their hydrophobic tails pointing outwards towards the aqueous solution, thus making the effective particle surfaces sufficiently hydrophobic for bubble attachment to occur. Although this summarizes their primary role, being surface active, collector surfactants sometimes also function as frothers (see below). Collectors are frequently cationic surfactants, in which case the surfaces of the minerals to be floated would be adjusted to ensure they are negatively charged, often through pH adjustment. Some commonly used collectors in mineral flotation include short-chain alkylxanthates (for base metal sulphides), carboxylates and sulfonates (for non-sulfide minerals of heavy metals), long-chain amines (for quartz, mica, barium sulfate, feldspars, and potash), and long-chain fatty acid soaps (for phosphates, hematite, and oxidized sulfides) [53,91,266]. Even minerals with naturally hydrophilic surfaces, such as coal, graphite, or talc, may benefit from the use of a collector such as an emulsified, non-polar oil like kerosene [621]. A review of collector surfactant types is given by Leja [91].

Each collector works effectively only within a certain pH range, within which it has the appropriate electric charge. Therefore, considerable use has been made of pH and zeta potential in developing an understanding of mineral flotation and the role of the collectors. There can be a marked relationship between zeta potential, collector (surfactant) adsorption, and flotation efficiency. Flotation is enhanced when the solids become hydrophobic, as shown in the mineral-flotation example of Figures 10.3 and 10.4. Figure 10.3 shows how, at low pH, the mineral particles have a positive surface charge (zeta potential) that leads to adsorption of the anionic collector surfactants (a), which in turn leads to excellent air-bubble attachment and flotation efficiency. Conversely, at high pH, the mineral particles have a negative surface charge that leads to adsorption of the cationic collector surfactants (b), which again leads to excellent air-bubble attachment and flotation efficiency. The process



**Figure 10.3** The dependence of the flotation properties of goethite ( $\text{FeO}(\text{OH})$ ) on surface charge. Lower curves show the flotation recovery in  $10^{-3}$  M solutions of dodecylammonium chloride, sodium dodecyl sulphate, and sodium dodecyl sulphonate. From Fuerstenau [623]. Copyright 1962, American Institute of Mining, Metallurgical and Petroleum Engineers.

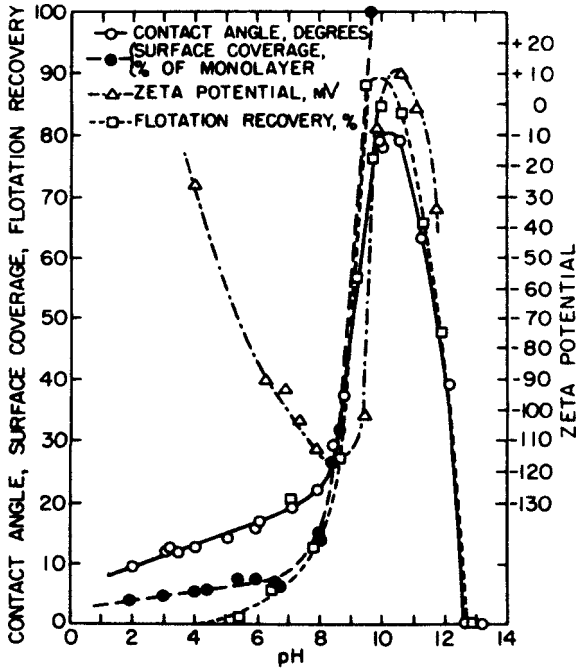


Figure 10.4 The correlation among collector surface coverage, contact angle, zeta potential, and flotation recovery for the flotation of quartz using dodecylammonium acetate. From Leja [91]. Copyright 1982, Plenum Press.

step in which the surfaces of mineral particles are intentionally altered so that they will be hydrophilic, or hydrophobic, as desired, is called conditioning.

Several other key classes of flotation aid chemicals exist.

- Frothers are surfactants that contribute stability to the froth (foam) so that it will last long enough for solely mechanically-entrained particles to fall back into the pulp phase before the froth is skimmed. Frothers are frequently non-ionic surfactants, such as cresol. Frothers may also aid the particle-bubble attachment process. Typical frothers include a variety of alcohols including  $\alpha$ -terpineol (pine oil), cresol, polypropylene glycols, short-chain alcohols, and methylisobutylcarbinol (MIBC).
- Activators are chemicals that permit or reinforce the adsorption of collectors onto particles, usually by complexing with the collector, or “bridging” between the collector and the solid. For example, sphalerite ( $\text{ZnS}$ ) can only be floated using ethyl xanthate as a collector if the particles are first treated with copper sulfate. The copper species adsorbs first and acts as a bridge to the xanthate, allowing it to function as a collector for the sphalerite.

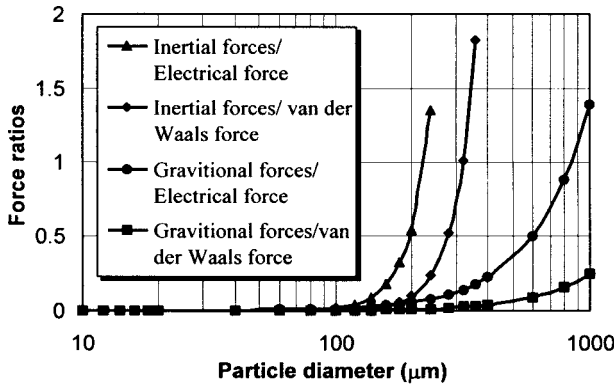
- Depressants (or deactivators) are chemicals that ensure that undesired particles remain hydrophilic and therefore do not get floated. Conversely to the activation of zinc sulfide by copper ions above, zinc ions from zinc sulfate act as a depressant for zinc sulfide. Another example is the use of cyanide to complex with copper and prevent adsorption of collectors in the flotation of base-metal sulfides with xanthates. There are many other depressants but they tend to be quite specific to one of a few types of minerals. In some cases, such as some uses of cyanide as a depressant, the mechanism of depressant action remains unclear.

Sparging is the introduction of gas bubbles into a liquid through fine orifices. In a flotation cell the size of the air bubbles introduced near the impeller is important. The size of bubbles produced at a submerged orifice can be estimated by assuming that, at the moment of bubble release from the orifice, the buoyancy and surface tension forces are equal. This produces the following approximate equation [281] for the bubble size:

$$r \approx (3\gamma r_o / 2\rho g)^{1/3} \quad (10.1)$$

where  $r_o$  is the radius of the orifice. The surface tension here should be the dynamic surface tension appropriate to the bubble lifetime at the point of release. Also, any degree of wetting of the orifice surface by the air will influence the bubble size beyond what is predicted by Eq. (10.1).

The sizes of the particles to be floated is also very important. For particles that are between about 1 nm and 1  $\mu\text{m}$  in diameter the forces of gravity and inertia are negligible compared with the surface forces, and particle-bubble collisions can lead to perikinetic (Brownian motion induced, see Section 5.5) aggregation. The difficulty in floating very small particles is in getting particles to attach to bubbles. Nevertheless, the fact that nanometre-scale precipitates, and even metal ions, can be floated, suggests that there is no inherent minimum particle size for flotation. For larger, but still small, particles that are between about 1 and 10  $\mu\text{m}$  in diameter particle-bubble collisions can lead to orthokinetic (flow or shear induced, see Section 5.5) aggregation. Figure 10.5 shows how inertial and gravitational forces become much more important when the particle size exceeds 100  $\mu\text{m}$ . The upper size limit for many practical mineral particle flotation under turbulent flow conditions, appears to be in the range 200–300  $\mu\text{m}$  [53,91,625] but there are exceptions. The upper size limitation is determined by the trade-off between the stability of particle-bubble adhesion versus the tendency for sedimentation during the period of rise in the flotation cell. The difficulty in floating large particles is in obtaining multiple bubble attachments per particle and in maintaining them long enough for the particles to be recovered. Flotation seems to be most effective when applied to particles having sizes in the range 10–200  $\mu\text{m}$  [53,91], although the exact range varies and depends on the physical properties of the minerals to be floated. For example, larger than 200  $\mu\text{m}$ -sized sulfide minerals (like pyrite) and coal particles (up to about 1 mm) can be floated effectively. In addition, although this is perhaps of greater scientific

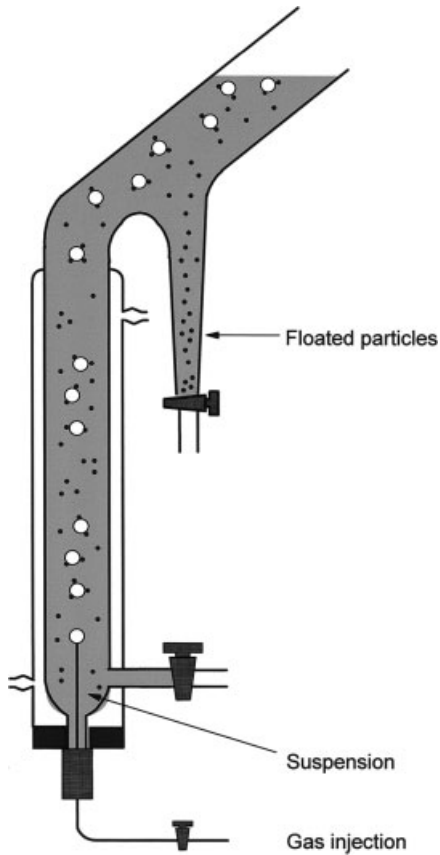


**Figure 10.5** Magnitudes of body to surface forces for different particle sizes. From Nguyen and Schulze [53]. Copyright 2004, Dekker.

than industrial interest, larger-sized particles of up to about 4 mm in size can be floated in situations where there is no turbulence [625].

Practical flotation processes, however, take place under conditions of turbulence. Turbulent flow, as opposed to laminar flow (see Section 6.1), is characterized by rapid, almost random, fluctuations in flow velocity. Turbulence helps keep the solid particles suspended, helps disperse the injected air phase into bubbles, and helps induce particle-bubble collisions and attachments. With regard to the role of turbulence in mineral flotation, a rule of thumb for suspension stability is the “one-second criterion” which states that the particles in a suspension are sufficiently well dispersed for flotation if individual particles do not remain settled at the bottom of the flotation vessel for longer than one second [53].

The efficiency of particle-bubble encounters is determined by the effects of the various forces that can cause a particle to depart from the streamlines surrounding a bubble’s surface and make possible a particle-bubble encounter. The theory involved is beyond the scope of this book, but a review is provided by Nguyen and Schulze [53], taking into account gravitational, inertial, and interception mechanisms. Beyond the particle-bubble encounter some additional time, the induction time, is needed in order for the thin aqueous film to drain, the film to rupture, and for a reasonable stable three-phase contact to establish. In order to achieve particle capture the particle-bubble contact time therefore has to be at least as large as the induction time. Finally, a particle may collide with a bubble essentially head-on or at an angle. If head-on, the bubble surface will deform considerably (here the contact time is called the collision contact time). If the angle is severe enough the bubble surface may not distort at all (here the contact time is called the sliding contact time). A range of theories have been developed for the different possibilities [53,625] and several kinds of apparatus have been developed to provide experimental data on encounter and capture efficiencies. Figure 10.6 provides an illustration of an apparatus that provides both visualization and collection of the floated particles.



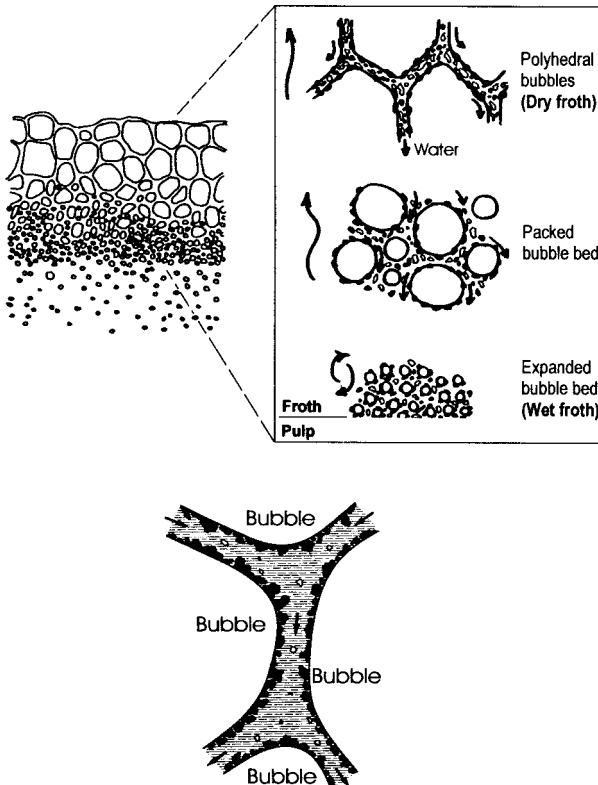
**Figure 10.6** Illustration of a flotation column for the study of particle capture and flotation by individual bubbles.

As discussed in Section 1.2.2 the bubble shapes in fairly dry foams and froths ( $\phi_{\text{gas}} > 0.83$ , approximately) are not spheres or distorted spheres, but polyhedrons. In practice there will be distributions of both gas-cell sizes and shapes. In addition to the gas bubbles, froth contains the floated particles, pulp liquor, and a fraction of (hydrophilic) particles that did not float due to bubble attachment, but which were mechanically entrained in the froth. The pulp liquor and these latter particles all have to be allowed to drain back out of the froth. The rate of this drainage will be greatest at the froth–pulp interface (i.e., the bottom of the froth layer) and slowest near the top of the froth layer. Froth drainage equations are discussed elsewhere [53]. The froth needs to be a stable enough foam that some time can be allowed for these drainage processes, and also so that the upper layer(s) of the froth can be swept out of the flotation cell. On the other hand, the froth should not be too stable as a foam so that it will break easily after collection. In addition to the role of the frother, froth stability is also promoted by increasing liquid viscosity.

Overall there will be a concentration of the hydrophobic particles in the upper regions of the froth layer and a concentration of the hydrophilic particles in the lower regions. Figure 10.7 provides an illustration of how froth structure changes from the bottom to the top of the froth layer. At the very top of the froth bubble, coalescence and rupture will be occurring as well. The amount of ore that can be separated for any given amount of liquid is proportional to the surface area of the foam. It has been estimated that a foam with a specific surface area of  $0.2 \text{ m}^2\text{g}^{-1}$  can separate a thousand times more ore, by mass, than the mass of its own liquid [629].

Having described the basic flotation process, there are some different ways in which it can be used to separate valuable minerals.

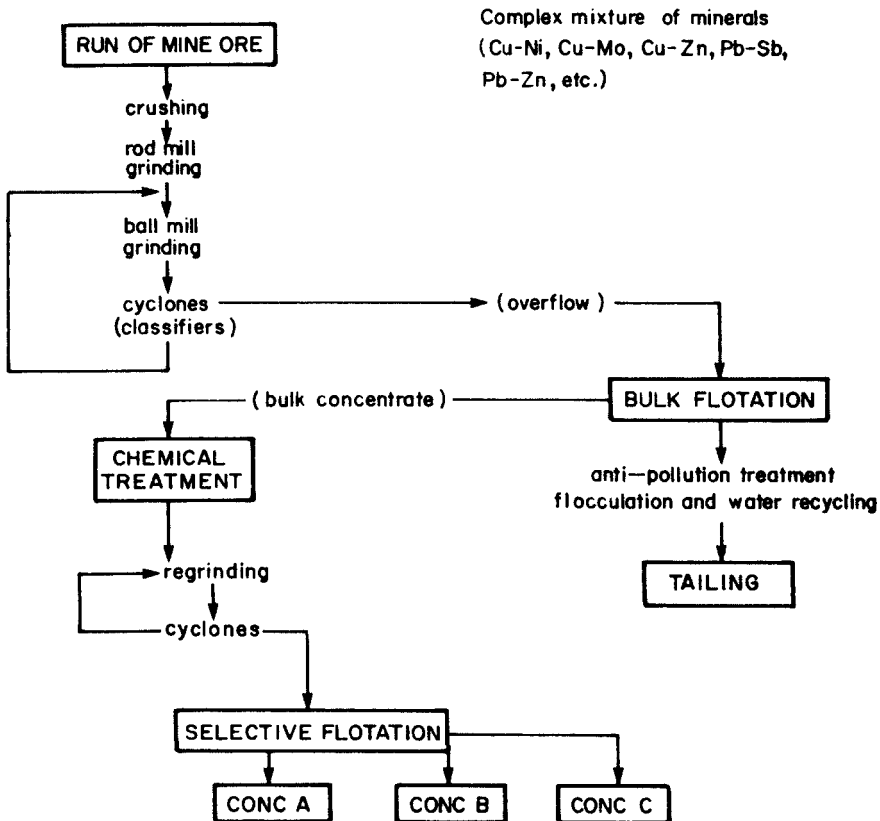
- Scalping flotation is where a first flotation step is practised in order to remove a minor, hydrophobic mineral. This mineral could be one that is valuable, such as  $\text{MoS}_2$  in a Cu-Mo ore [91], or one that is unwanted, such as talc.



**Figure 10.7** Illustration of the draining froth layer formed on the pulp surface (top, left), producing dry foam on the top and wet foam at the bottom (top, right). Gangue particles drop back to the pulp with the draining water (bottom, left). From Nguyen and Schulze [53]. Copyright 2004, Dekker.

- Roughing flotation is essentially a first-pass flotation of desired minerals that are well liberated, well conditioned, and are readily floated. This may produce a relatively low-grade froth. At this stage the minerals are only partially liberated from the gangue and some particles will contain both valuable and gangue minerals.
- Scavenging flotation is a subsequent flotation step that is applied to the tailings from the roughing stage. This step is intended to float those minerals that require longer treatment time, a higher flotation aid concentration, or otherwise different flotation operating conditions from the roughing stage.

Froth flotation has been used to separate many raw-mineral ores, such as those for copper, lead, zinc, and tungsten. If two valuable minerals are very difficult to separate from each other then a sequential set of flotation stages may be needed. An illustration is provided in Figure 10.8. First, enough grinding is applied to permit the two minerals to be liberated from the non-valuable gangue minerals. A first,



**Figure 10.8** Illustration of a selective flotation process for the separation of heavy metal sulfides such as Cu-Mo, Cu-Ni, or Ni-Co-Cu, from unwanted gangue minerals, and from each other. From Leja [91]. Copyright 1982, Plenum Press.



“bulk” flotation is applied to separate these minerals from the gangue (somewhat like a scalping flotation). With the mineral concentrate thus produced, additional grinding may be needed to fully separate the two minerals from each other. Chemical treatment may then be needed to destroy, or at least remove, the collector that had been used in the bulk flotation. At this point one of the valuable minerals may already be in a hydrophobic state while the other is not. If so, one can proceed directly to the next flotation stage, with a suitable frother. If not, then a new collector will first have to be added that only makes one of the minerals hydrophobic. In either case the next, “selective” flotation will yield a concentrate that is rich in one of the valuable minerals while the tailings will be rich in the other. This approach can be applied to the complex sulfides of copper and nickel, or of nickel, cobalt and copper, or of lead and zinc, or others [91,621]. With sufficient use and control of appropriate collectors, activators, deactivators, and frothers even complex mixtures of, for example,  $\text{Cu}_2\text{S}$ ,  $\text{CuFeS}_2$ ,  $\text{PbS}$ ,  $\text{ZnS}$ ,  $\text{FeS}_2$ ,  $\text{CaF}_2$ , and  $\text{SiO}_2$  can be separated selectively, and in succession, into fairly pure individual components [91,621].

**Example: lead-zinc recovery.** Lead and zinc minerals often occur together and are selectively floated and recovered. The main lead mineral is galena ( $\text{PbS}$ ). The main zinc minerals are sphalerite/wurtzite ( $\text{ZnS}$ ) and marmatite ( $\text{ZnS} + \text{FeS}$ ). (The actual ore composition is slightly more complex than this [91].) An overall commercial grade ore might contain between 5 and 20% total lead and zinc. The galena would be floated first under conditions of alkaline pH (pH 8–10) using a low concentration of an alkyl xanthate as the collector, sodium sulfite to depress the zinc minerals, and a short-chain alcohol as a frother. After galena flotation the pH would be raised to 11–12 (to depress gangue iron sulfides), copper sulfate is added to activate sphalerite and marmatite, and additional alkyl xanthate is added to float these two minerals. The final lead concentrate should be more than half lead with minimal zinc content; the final zinc concentrate should be more than half zinc with minimal lead content.

**Example: potash.** A major use of potassium salts is in the making of fertilizer. The term potash refers to a mixture of potassium-bearing minerals. The main salt is sylvite ( $\text{KCl}$ ), but there may also be langbeinite ( $\text{K}_2\text{SO}_4$ ), kainite ( $\text{MgSO}_4 \cdot \text{KCl} \cdot 3\text{H}_2\text{O}$ ), and carnallite ( $\text{KCl} \cdot \text{MgCl}_2 \cdot 6\text{H}_2\text{O}$ ), in addition to numerous other potassium-containing salts. A typical commercial-ore grade in Canada, for example, would be in the range 20–35%, expressed as  $\text{K}_2\text{O}$  equivalent. The raw ore is crushed and dispersed in a concentrated brine solution. Clay minerals are removed (de-slimed) by hydrocyclone, since these otherwise consume flotation reagents. Next there are two options. Halite ( $\text{NaCl}$ ) can be selectively floated using n-alkyl carboxylates (collector), heavy metal ions (activator), and a non-polar oil (additional collector). This yields a concentrated dispersion of the potash. Alternatively, the potash can be selectively floated from a saturated brine solution, using n-alkyl amine as the collectors, leaving the other salts behind. The flotation steps may involve a sequence of rougher, cleaner, and re-cleaner stages. Either way the collected potash would be centrifuge de-watered, dried, then sized by screening. The final potassium concentrate would probably be at least about 60%,

expressed as  $K_2O$  equivalent. The actual ore composition and selective flotation process may be more complex than this description [91].

In contrast to conventional flotation, in which the desirable mineral is directly floated and collected from the produced froth, reverse (indirect) flotation aims to have the undesirable minerals preferentially floated and removed, leaving behind a slurry that has been concentrated in the desirable mineral. This method has been used for the purification of iron ore and the separation of salt from potash. The next section describes some other variations on conventional froth flotation.

### 10.3.1

#### **Carrier, Emulsion, and Floc Flotation**

Some modifications to the standard froth-flotation process have been developed in order to improve separation and recovery efficiency including carrier flotation, emulsion flotation, and floc flotation. These are all aimed at making very fine particles amenable to flotation, or at improving the efficiency of their flotation.

In carrier flotation, small-sized (several  $\mu\text{m}$  diameter) particles become attached to the surfaces of larger particles (perhaps 50  $\mu\text{m}$  diameter, the carrier particles) [630]. The carrier particles attach to the air bubbles and the combined aggregates of small desired particles, carrier particles, and air bubbles float to form the froth. An example is the use of limestone particles as carriers in the flotation removal of fine iron and titanium oxide mineral impurities from kaolinite clays [630]. The use of a fatty acid collector makes the impurity oxide particles hydrophobic; these then aggregate on the carrier particles. In a sense, the opposite of carrier flotation is slime coating, in which the flotation of coarse particles is decreased or prevented by coating their surfaces with fine hydrophilic particles (slimes). An example is the slime coating of fine fluorite particles onto galena particles [630].

Emulsion flotation is analogous to carrier flotation. Here, small-sized particles become attached to the surfaces of oil droplets (the carrier droplets). The carrier droplets attach to the air bubbles and the combined aggregates of small desired particles, carrier droplets, and air bubbles float to form the froth. An example is the emulsion flotation of submicrometre-sized diamond particles with isoctane. Emulsion flotation has also been applied to the flotation of minerals that are not readily wetted by water, such as graphite, sulfur, molybdenite, and coal [623]. Some oils used in emulsion flotation include mixed cresols (cresylic acid), pine oil, aliphatic alcohols, kerosene, fuel oil, and gas oil [623]. A related use of a second, immiscible liquid to aid in particle separation is in agglomeration flocculation (see Section 5.6.4).

Similarly, in floc flotation the small-sized particles become aggregated into flocs that can attach to the air bubbles. Here, polymers may be used to induce the required level of flocculation. Examples include the floc-flotation of coal fines [631] or galena [632].

Finally, a rather unusual application of froth flotation is in the separation of damaged or poor quality fruit (see pp. 363–364 in Ref. [633]).

## 10.4

### Tailings and Tailings Ponds

The grinding, conditioning, and flotation processes used in mineral processing tend to produce, as an unwanted by-product, gangue, a kind of dispersion that is undesirable: that of very finely divided, often colloidal-sized particles dispersed in the process tailings [447]. Some commercial mineral processing operations recover less than 3% of the ore being processed, with the remainder going to tailings [607]. This makes tailings handling and disposal a significant issue. The tailings suspensions can cause difficulties in handling, transportation, and disposal, not to mention the long sedimentation times that may be required to achieve separation from the aqueous phase [620]. Mineral-process tailings, such as those from copper mines, may also be toxic and a cause of other environmental problems. Similar but more complex tailings are produced by oil-assisted, oil, and bitumen flotation processes (see Section 11.3.2). These suspensions consist of fine mineral particles plus residual emulsified oil, and the variability of these suspensions means that tailings treatment processes can be quite specific to individual process types and ore bodies [634]. The consolidation and de-watering of large volumes of flotation-process tailings amounts to hundreds of millions of cubic metres in some cases; a large industrial tailings pond can measure 1 km by 1 km by several metres deep. These ponds almost always present significant colloid-chemical challenges.

The tailings from the various flotation stages of an industrial separation process can be combined and hydraulically transported by pipeline ([90,606], see also Section 10.2). Sometimes the tailings pipelines are close to the separation plants, and therefore are of modest length, but it is not uncommon for such pipelines to extend for several tens of kilometres to a settling basin.

Following pipeline transport and deposition into a tailings pond, the coarse sand fraction will begin to settle out and can be dredged and used to form beaches and dykes around the tailings ponds, for containment [606]. This is not as straightforward as it may seem and the material properties of these barriers must be carefully controlled since poor construction, or subsequent events like erosion or liquefaction of the solids can cause severe failures, with catastrophic results [606].

The fines fraction (fine sand, silts, clays and any emulsified oils) not retained within the sand can be run off to a separate containment pond. Some water is usually quite readily released during the subsequent settling and densification of the fines slurry and may be suitable for drawing-off and recycling back to the mineral-separation process. The water-release process, however, can take a very long time (as much as several years) and can still leave a significant volume of mature fine tailings that may have a solids content of the order of 70 mass % solids [634]. Government regulations may mandate that the containment ponds eventually be reclaimed to a natural landscape. In commercial plants operating with “zero discharge” of process-affected waters, water management of both present and future inventories is a complex issue, as can be seen in Figure 10.9, and can involve millions of cubic metres of suspension [635]. Accordingly, much effort has been

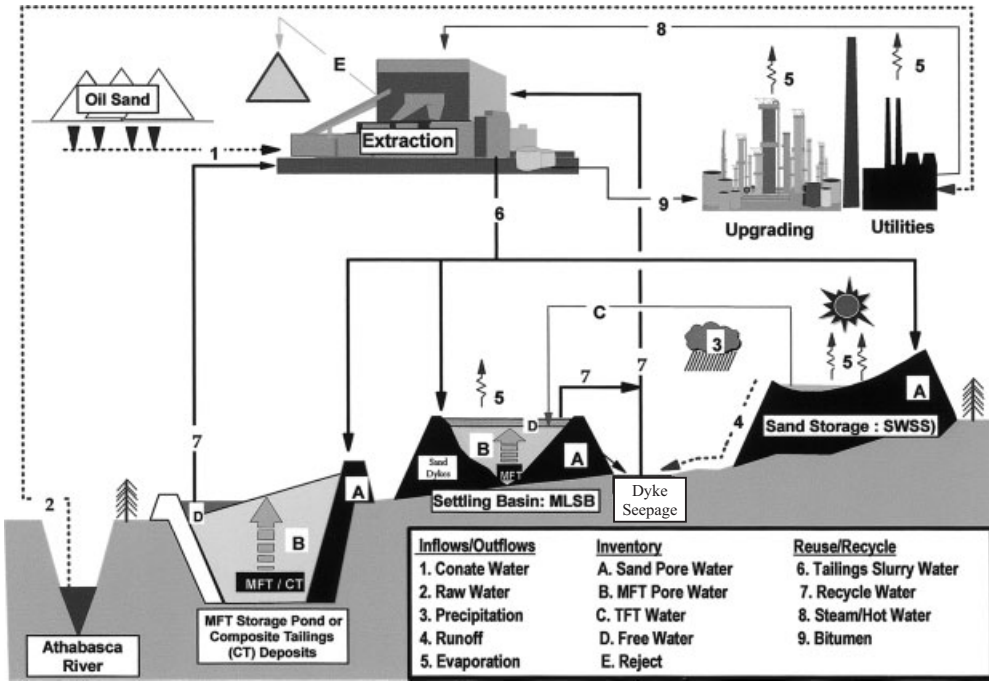
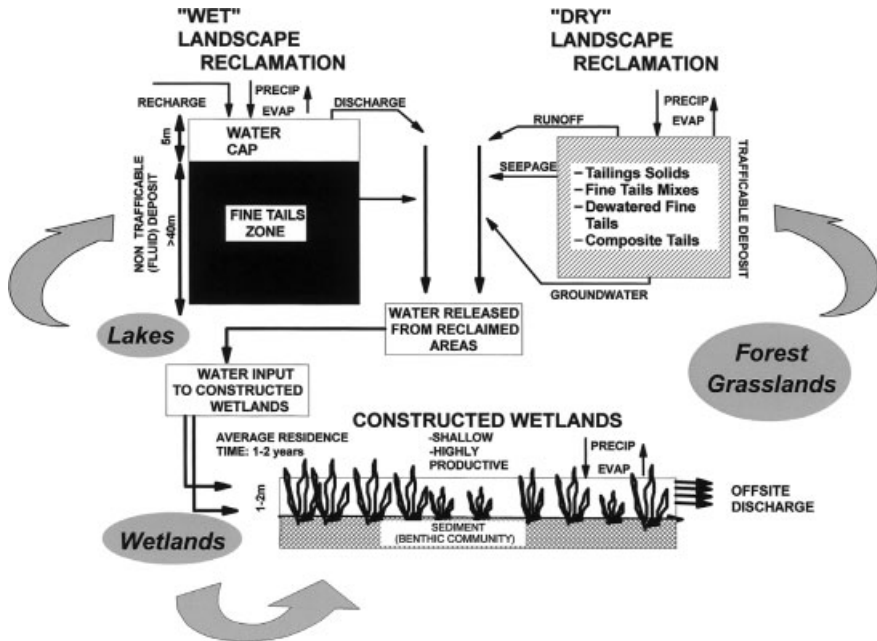


Figure 10.9 Simplified tailings management operations from a flotation process. From Schramm *et al.* [642] Copyright 2000, Cambridge University Press.

expended over many years in looking for efficient and cost-effective methods for managing such tailings (e.g., [634,636,637]).

The properties of the tailings waters are affected by the nature of the flotation process that produced them. Any dissolved components, including inorganic salts and dissolved organics associated with the water phase, are the most mobile, either through direct discharge or through long-term seepage or release into the reclaimed landscape. The solids fraction in the process tailings includes sand, silts, and clays, and may include undissolved organic compounds. This fraction should develop into trafficable deposits and may be suitable for terrestrial reclamation strategies, especially if blended with a suitable proportion of coarse tailings solids [638]. Fluid tailings will be incorporated into these deposits or will be placed in secure storage areas where they may retain their fluid character for a long time. The latter case is described as a “wet” reclamation option, and entails the formation of water-capped fine tails lakes or wetlands in which viable self-sustaining aquatic habitats can develop [639–641].

The properties of the water are important factors in the success of both “dry” and “wet” reclamation options, as is shown in Figure 10.10. The acute and chronic impacts of the process-affected waters on aquatic biota, wildlife, plants and humans exposed to them, are complex and typically require ongoing investigation. The com-



**Figure 10.10** Components of fine tailings reclamation. From Schramm *et al.* [642] Copyright 2000, Cambridge University Press.

mon feature in these landscape units is the water. The inorganic salts or dissolved organic matter leached from the original mineral ores or added by process chemicals will have the potential to affect the plants used in terrestrial habitats, as well as the abundance and diversity of aquatic biota [638]. This raises issues such as survival, growth, fecundity and diversity of the reclaimed ecosystem. In some cases most of the short-term detrimental biological effects of the process-affected waters to aquatic organisms have been shown to be associated with the organic acids in the dissolved organic fraction [641]. In other cases the detrimental biological effects will be due to dissolved inorganic species, such as toxic metal ions.

Where oils have been used in the flotation process, or where the process involved direct crude-oil flotation, emulsions may be discharged to or created in the tailings ponds [634,642]. Beyond the emulsified oil some fraction of organic compounds from the oil, such as naphthenic acids, may become introduced into the tailings [638,643]. Naphthenic acids can be acutely toxic to many aquatic biota [638,642,644], although with ageing the toxic response per unit of naphthenic acid may decrease due to natural bioremediation processes [642]. With time, waters will be slowly released from the various sinks (sand deposits, fine tails). If the rate of their release is less than the rate of the bioremediation processes, then the resulting waters should have the toxic components of the naphthenic acid group reduced to levels that will ensure the waters are neither acutely nor chronically toxic [638,641].

Ongoing research aims to assess the short and long-term potential of bioremediation processes to treat process-affected waters and meet acceptable water-quality criteria for preventing detrimental biological influences [635,638,640].

To avoid the occurrence of tailings ponds, and their associated problems, some mineral-process tailings are drawn off from the rougher and scavenger stages, thickened, de-watered in centrifuges, and then dried in, for example, gravity-fed, direct-fired driers for dry disposal.

## 10.5

### Dust-Suppressing Foam Blankets

The application of foam blankets as temporary covers for environmental applications was introduced in Section 9.6 (see also Section 13.9). Several kinds of foams have also been developed for use in the suppression of respirable coal dusts at mine faces (especially during underground mining), at conveyor transfer points, and during any kind of dry processing [645–648]. Ideally these foams should adhere to the coal so that the fine particles (less than 10  $\mu\text{m}$ ) will not easily become airborne even away from the point of application and after the foam has collapsed. This has been accomplished by foaming an emulsion so that an oleic coating would be left on the coal particles [645] and by incorporating polymers that coat the particles in addition to thickening the foam [647,648].

Other dust-suppressing applications of foam blankets include:

- road dusts,
- cement clinker dust,
- mineral sulfide and sulfate dusts, and
- grain dust generated during transportation and handling and storage. Here the issues are both respirable dusts and also potentially explosive dusts in grain elevators [649,650]. In this case the residual materials left on grain surfaces after foam collapse, have to be edible. Protein-stabilized foams have been developed for this purpose [649,650].

Other applications of foam blankets are discussed in Sections 9.7 and 13.9.



## 11

**Petroleum Industry Applications**

Crude oils consist of a range of hydrocarbons (alkanes, naphthenes and aromatics) as well as phenols, carboxylic acids and metals. There may be a significant fraction of sulfur and nitrogen compounds present as well. The carbon numbers of all these components range from 1 (methane) through 50 or more (asphaltenes). Some of these components can form films at oil surfaces while others are surface-active. Some, such as asphaltenes, are easily precipitated. Another fraction of crude oil, the resin fraction, can stabilize a dispersion of these asphaltenes in the oil. Since asphaltenes can act as coke precursors and catalyst foulants, asphaltene precipitation, dispersibility, and compatibility are important issues in the control of upgrading and refining processes. See Ref. [4,651]. Considering the broad range of oil components, it is to be expected that the tendencies to form stable or unstable emulsions of different kinds varies greatly among different oils. So too does the nature of interactions of crude oils with foams and suspended solids.

Due to the wide range of possible compositions, crude oils can exhibit a wide range of viscosities and densities, so much so that these properties are used to distinguish light, heavy and bituminous crude oils [652–654]. Since the reference viscosities correspond to ambient deposit temperatures, the variation in these properties over different temperatures can broaden the physical differences among crude oils. For example, bitumen in the Athabasca deposit in north-western Canada is chemically similar to conventional crude oil but has a viscosity, at reservoir temperature, of about  $10^6$  mPa·s (one million times greater than that of water). During heating, as part of an oil-recovery process such as hot-water flotation or *in situ* steam flooding, emulsions having a wide range of viscosities can be formed, particularly if they are of the water-in-oil type. When these different kinds of oils are emulsified, the emulsions may have viscosities that are much greater than, similar to, or much less than the viscosity of the component oil, all depending on the nature of the emulsion formed.

Emulsions, foams, and suspensions occur or are created throughout the full range of processes in the petroleum producing industry (see Table 11.1), including drilling and completion, fracturing and stimulation, reservoir recovery, surface treating, transportation, oil spill and tailings treating, refining and upgrading, and fire-fighting. Any of these dispersions may be carefully stabilized to assist one stage of an oil-production process, but may be undesirable, and need to be prevented or broken in another stage (Table 11.1). For example, emulsion drilling fluids are desirable but emulsions in production



fluids usually are not. Similarly, foams injected as part of an enhanced oil-recovery process are desirable, but foams in refinery distillation towers are not. Stimulation fluid suspensions are desirable, but suspensions created as a result of fines migration in a reservoir are not. A number of books provide very useful introductions to the properties, importance, and treatment of emulsions [2,37,39,40,421,470], foams [3,43,44,46], and suspensions [4,655,656] in the petroleum industry. For a more general introduction to the technology of petroleum and oil recovery see [133,420,651].

**Table 11.1** Some emulsions, foams, and suspensions in the petroleum industry\*.

Undesirable	Producing (well-head) emulsions	W/O	
	Producing oil-well and well-head foams	G/O	
	Fuel-oil emulsions	W/O	
	Oil-flotation process froth emulsions	W/O, O/W	
	Oil-flotation process diluted froth emulsions	O/W/O	
	Oil-spill mousse emulsions	W/O	
	Tanker bilge emulsions	O/W	
	Distillation and fractionation tower foams	G/O	
	Fuel oil and jet fuel tank (truck) foams	G/O	
	Migrating fines in a reservoir	S/W	
	Dispersions of asphaltenes in crude oils	S/O	
	Migrating fines during secondary and enhanced oil recovery	S/W	
	Producing (well-head) solids in conventional oil recovery	S/W, S/O	
	Oil-sands tailings ponds	S/W	
Oil-field surface facility sludges	S/W, S/O		
Desirable	Foam drilling fluid	G/W	
	Foam fracturing and stimulation fluids	G/W	
	Foam acidizing fluid	G/W	
	Producing (well-bore) foams in cold, heavy-oil recovery	G/O	
	Oil-flotation process froths	G/O	
	Fire-fighting foam	G/W	
	Heavy-oil pipeline emulsions	O/W	
	Well-stimulation emulsions	O/W, W/O	
	Oil and oil-sand flotation-process emulsions	O/W	
	Emulsion drilling fluid:	oil-emulsion mud	O/W
		oil-based mud	W/O
	Asphalt emulsion	O/W	
	Enhanced oil recovery <i>in situ</i> emulsions	O/W	
	Emulsion fuel emulsion (70% heavy oil)	O/W	
	Transportation fuel emulsion (70% heavy oil)	O/W	
	Sludges from acid stimulation treatments	O/W, W/O	
	Blocking and diverting foams	G/W	
	Gas-mobility control foams	G/W	
	Drilling fluid (mud) suspensions	S/W	
	Well stimulation and hydraulic fracturing suspensions	S/W	
Well cementing slurries	S/W		
Oil-sand slurries in bitumen recovery	S/W		
Producing (well-head) solids in primary heavy oil recovery	S/W		

\* Dispersion abbreviations include water (W), oil (O), gas (G), and solids (S).

## 11.1

### Oil Wells and Near Wells

#### 11.1.1

##### Drilling and Completion Fluids

High-performance drilling fluids are needed for the safe and efficient drilling of oil wells. Drilling fluids are used to maintain hydrostatic pressure in the borehole, to avoid reducing permeability in the near-wellbore region, to clean the wellbore by carrying drilled rock cuttings to the surface, to cool and lubricate the drill bit, to maintain wellbore stability, and to be disposable with minimal environmental impact [380,656]. Several of the rheological models discussed in Section 6.3 are commonly used to describe drilling-fluid behaviour, including the power-law model and the Hershel–Bulkley model [657].

Classical drilling fluids were suspensions (i.e., drilling muds), usually formulated from clays and water. The DLVO theory of colloid stability discussed in Section 5.2, and the rheological models discussed in Sections 6.5 and 6.7, have been applied to the formulation and application of classical drilling-fluid suspensions [658]. Modern drilling fluids can be highly complex multi-phase dispersions of which there are two broad classes, water-based, meaning water-continuous, and oil-based, meaning oil-continuous. The former are usually still suspensions, often containing barite and bentonite, but may be foams. The latter are usually emulsions, but there are now several oil-based drilling-fluid suspensions as well. A large number of drilling-fluid formulations have been developed and applied [655].

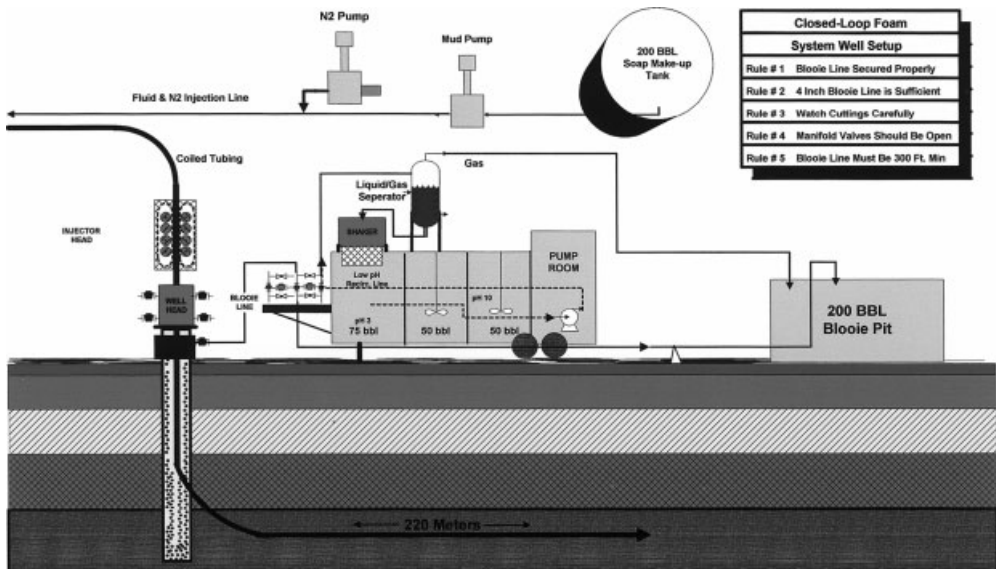
Emulsion drilling fluids are used in either form, water-continuous and oil-continuous (invert). Invert emulsion fluids provide good rheological and fluid-loss properties, are particularly useful for high-temperature applications, and can be used to minimize clay hydration problems in shale formations [380]. As with classical drilling fluids, careful formulation is needed in order to minimize fluid loss into the formation, to provide the functions listed above to assist drilling, and to be disposable with minimal environmental impact [655,656,659]. The oils used to make the emulsions were originally crude oil or diesel oil, but are now more commonly refined mineral oils [380]. Oil-continuous, or invert, emulsion fluids are typically stabilized by long-chain carboxylate or branched polyamide surfactants. Borchardt [659] lists a number of other emulsion stabilizers that have been used. Organophilic clays have also been used as stabilizing agents.

Air, mist, and foam drilling fluids can yield superior drilling penetration rates compared with conventional mud systems [485,660–665]. There are several possible flow regimes [485,666]. In mist drilling, the fluids are injected as a mist, which changes to foam before returning up the annulus of the well, removing with it formation brine that has entered the well. Since foams can exhibit a high carrying capacity (viscosity), they can also be used for sand or scale clean-outs. Foam drilling fluids are used for underbalanced drilling of horizontal wells [485,667–669], a method in which the drilling fluid is kept at lower pressure than the reservoir, so that the drilling fluid and cuttings will neither erode nor penetrate and potentially damage

the reservoir. Polymer-thickened foams have also been used for enhanced cuttings-carrying capacity [659,670]. Foam qualities in the range 95–98% (v/v) tend to provide the best carrying capacities. By carefully selecting the type of surfactant, one can adjust the brine salinity and oil tolerances of the foam.

Foams intended for use in wells and in several near-well reservoir processes are pre-formed at the surface before injection. The foam generators used can be quite simple, involving mixing surfactant-containing and gas streams at a high flow velocity and then causing them to experience a sudden pressure drop across a choke, valve, or a canister containing packed, porous media. These methods produce very high shear rates, which can cause a problem if polymers are incorporated into the foam. More sophisticated foam generators, that permit some control over the shear forces imparted, are also available [671]. In some cases the foam is continuously reconditioned and recirculated, as illustrated in Figure 11.1 [485].

Another application related to oil-well drilling is to use cement slurries to fill the annular space between the borehole and a cylindrical tube, called the casing, which lines the borehole. The purpose of the cement, once it has set, is to isolate the well-bore from reservoir fluids. This prevents the migration of such fluids in the annulus behind the casing, and protects the casing from corrosion by the action of reservoir fluids. Other applications of cementing slurries are to plug the deeper portions of wells, to permit production from shallower depths, and to plug channels behind the casing or perforation tunnels. A variety of tools and techniques are used to ensure that the cementing slurries are properly placed in the well. There are also a number of formulation challenges involved in the preparation of appropriate cementing slurries and of the fluids used to displace the slurries into their desired positions. These include ensuring the desired properties of rheology, density, colloidal stability, and thermal properties. See [672,673].



**Figure 11.1** Illustration of a closed-loop recirculating-foam system for drilling using coiled tubing. From Thomas and Wilkes [485]. Copyright 2000, Cambridge University Press.

## 11.1.2

**Well Stimulation: Fracturing and Acidizing**

Suspensions, emulsions, and foams can each be used to increase the injectivity or productivity of oil and gas wells by fracturing or acidizing. Regardless of the type of dispersion used, the goal is to increase flow capacity in the near-well region of a reservoir. Fracturing fluids are injected at high pressure and velocity, through a wellbore, and into a formation at greater than its parting pressure in order to create and extend fractures (cracks). Once the rock is fractured, the new flow channels are held open by injecting another suspension containing particles, called proppant, of sand or gravel. In this way, the fractures are kept open when pumping has ceased and the well is put into production [4,674,675]. Thus, suspensions have traditionally been used in hydraulic fracturing. Such suspensions are carefully formulated, with surfactants and polymers, to have the right rheological and hydraulic properties (i.e., good pumpability under high shear-rate conditions, and viscosity build-up, and good suspending power under low shear-rate conditions) [676,677].

There are also several types of fracturing fluid emulsions (including water and oil-based emulsions) [678,679] and foams (including water, oil, and alcohol-based foams) [680–685] which can provide good fluid-loss control, good transport properties, and be less damaging to the reservoir than suspension-based fluids. They were first applied for low-pressure reservoirs, but have now been applied to all types of oil and gas wells where it is important to minimize (water) damage to the reservoir. However, they are more difficult to prepare and can be more expensive. Although their formulation is even more complex, delayed gelling foams can be used to carry and place proppant in desired reservoir zones, including deeper and hotter reservoirs than have been possible for conventional fracturing fluids [684,686,687]. Chambers has reviewed the applications of foam-stimulation fluids [685].

Surfactants, sometimes incorporated into emulsions and foams, can be well-suited for acidizing, in which the injectivity or productivity of a reservoir is improved by dissolving fine particles from within flow channels. This increases the flow capacity in the near-well region. For carbonate reservoirs, these acidizing fluids can be up to 28 mass% in HCl and/or up to 13 mass% in organic acids such as formic or acetic acids [678,688]. For sandstone reservoirs, mixtures of HCl and other acids, such as HF, have been used [678]. In acidizing the matrix around gas wells, for example, low surface tension is needed to reduce the capillary forces that otherwise hinder deep acid penetration, and which trap spent acid in pores of the rock. The trapping and accumulation of spent acid, in particular, can lead to water-blocking, which can reduce the production of gas that the acidization was intended to increase. To prevent this, the surface tension can be reduced by adding short-chain alcohols and surfactants. The surfactants may also act to cause wettability alteration towards water-wet (see Section 3.4), break emulsions, or help to displace fine particles [678]. In some cases a separate foam, distinct from the stimulation fluid, is first injected into a reservoir, in order to have the foam fill high-permeability zones or channels and therefore prevent the entry into these areas of subsequently injected stimulation

fluid [678]. This can help ensure that the stimulation fluid is directed only to the lower permeability regions for which its action is desired.

Acid-in-oil emulsion can extend the propagation of acid considerable distances into a reservoir because the continuous (oil) phase prevents or minimizes contact between the acid and the rock [4,678,689]. Emulsification also increases viscosity and will improve the distribution of the acid in layered and heterogeneous reservoirs. Acidizing foams are aqueous, in which the continuous phase is usually hydrochloric acid (carbonate reservoirs) or hydrofluoric acid (sandstone reservoirs), or a blend, together with suitable surfactants and other stabilizers [345,659]. Foaming an acidizing fluid increases its effective viscosity, providing mobility control when it is injected [678].

## 11.2

### Reservoirs

#### 11.2.1

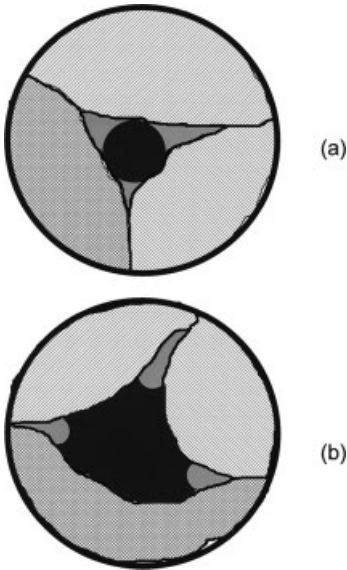
##### Primary and Secondary Oil Recovery

Oil is produced from a reservoir when either its own pressure (primary production) or an applied pressure (secondary and tertiary production) makes it flow through permeable porous rock formations and into a production well. Therefore, any mechanism that causes a reduction in the rock permeability is detrimental to oil production. Almost all reservoir rocks contain fine particles, especially clay minerals, that are only loosely attached to pore walls and which are susceptible to mobilization during flow of fluids through the porous rock, due to a combination of mechanical shear forces, colloid-chemical reactions, and geochemical transformations. The mobilization of fine particles often results in severe loss of the rock permeability due to trapping of the mobilized particles by a process analogous to deep-bed filtration. Permeability damage due to fines migration is a major concern in reservoir processes such as water flooding and acidization. The mechanisms causing fines migration, available descriptive models, and the problems and preventative measures available are described elsewhere [424,425].

In primary oil recovery from underground reservoirs, the capillary forces described by the Young and Young–Laplace equations are responsible for retaining much of the oil (residual oil) in parts of the pore structure in the rock or sand. It is these same forces that any secondary or enhanced (tertiary) oil-recovery-process strategies are intended to overcome [2,133,421,690,691]. In an oil-bearing reservoir the relative oil and water saturations depend upon the distribution of pore sizes in the rock. The capillary pressure in a pore is

$$P_c = 2 \gamma \cos\theta/R \quad (11.1)$$

where  $R$  is the pore radius, and at some height  $h$  above the free water table,  $P_c$  is fixed at  $\Delta\rho h$ . Therefore, since the interfacial tension and contact angle are also fixed,



**Figure 11.2** Illustration of capillary trapping in small (a) and large (b) water-wet pores. When at the same height above the free water level the radii of the oil/water interfaces will be the same. The larger pores contain less water as a percentage of pore volume.

and if the rock is essentially water-wetting (low  $\theta$ ), the smaller pores will tend to have more water in them (less oil) than larger pores [692], as illustrated in Figure 11.2. When water is injected into a reservoir to improve oil recovery it will tend to drive oil from the smaller pores if the rock is water-wet, and from the larger pores first if the rock is oil-wet.

One generally attempts to reduce the capillary forces restraining the oil and/or alter viscosity of the displacing fluid in order to modify the viscous forces being applied to drive oil out of the pores. The ratio of viscous forces to capillary forces actually correlates well with residual oil saturation and is termed the capillary number. One formulation of the capillary number is,

$$N_c = \eta v / (\gamma \phi) \quad (11.2)$$

where  $\eta$  and  $v$  are the viscosity and velocity of the displacing fluid,  $\gamma$  is the interfacial tension and  $\phi$  is the porosity. The functional form of the correlation is illustrated in Refs. [227,229]. After even the most efficient waterflooding,  $N_c$  is about  $10^{-6}$  and the residual oil saturation is still about 40% [227,229].

Emulsions are commonly produced at well-heads during primary and secondary (waterflood) oil production. For these processes the emulsification is usually not attributed to formation in reservoirs, but rather to formation in, or at the face of, the well-ore itself [693]. However, at least in the case of heavy-oil production, laboratory [694] and field [695,696] results suggest that water-in-oil emulsions can be formed in the reservoir itself during water and steamflooding. Energy is needed for emulsification, partly because of the increased surface area that is created in forming small droplets and partly because deformation of large drops is needed before smaller

drops can pinch off. The type of emulsion that will be formed is influenced by the critical Weber number,  $We$ , as discussed in Section 3.2.1:

$$We = (\eta_1 \dot{\gamma} \cdot R) / \gamma_{12} \quad (3.5)$$

where  $\eta_1$  is the viscosity of the continuous phase,  $\dot{\gamma}$  is the shear rate,  $R$  is the droplet radius, and  $\gamma_{12}$  is the interfacial tension. Figure 3.5 shows that for a given viscosity ratio,  $\eta_2/\eta_1$ , between the dispersed ( $\eta_2$ ) and continuous ( $\eta_1$ ) phases, reducing the interfacial tension increases the Weber number, lowering the energy needed to cause droplet break-up. The figure also shows that for a given flowing system in a heavy-oil reservoir, the viscosity ratio will be smaller, and an emulsion easier to form, if it is a water-in-oil emulsion rather than an oil-in-water emulsion.

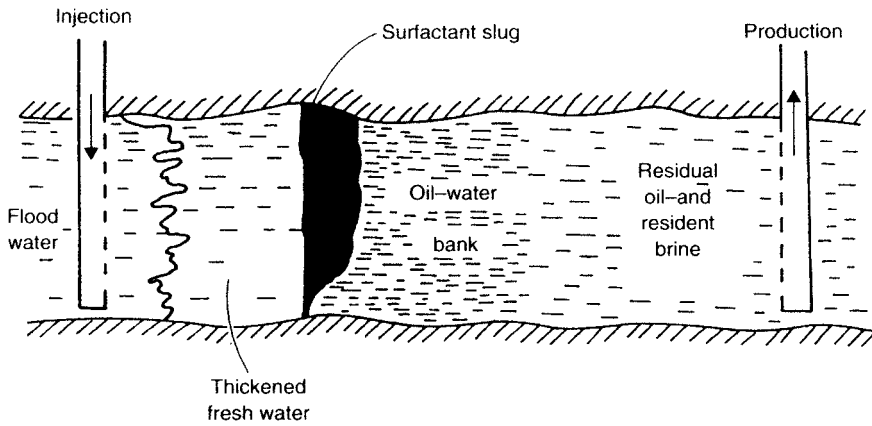
Waterflooding of a reservoir, especially when low salinity (low ionic strength) water is used, can cause fine solids to be dislodged from pore walls, and dispersed (peptized) from aggregates, to become dispersed into suspension. This is called fines migration [425]. The fine solids are usually stabilized by electrostatic repulsion and will flow with the moving water front. These solids may become produced with oil at a well-head or, more seriously, may simply flow until they become trapped in smaller pores. The latter case can cause plugging of zones in a reservoir [425,697]. Prevention of fines migration can sometimes be as simple as matching the ionic strength of the injected water to that of the reservoir formation water so that electric double-layers on the particles remain compressed. Since mechanical shear is involved in the dislodging of fine particles, the overall flow rate is also important.

Foams can also be produced during primary production because pressure is greater in the reservoir at the locations from which oil is being drained, and lower near and in the well-bore. As oil moves toward a producing well and then into the bottom of the well, the reduced pressure it experiences can cause dissolved gas to be released. When this happens to a light oil, the gas normally separates from the oil. In the case of some heavy oils, however, the gas remains dispersed in the oil as an *in situ* oil foam [339,698]. This is called foamy-oil production, and can be associated with increased primary-oil production compared to what would be expected from non-foamy-oil production. It is thought that the formation of foamy-oil delays the formation of a continuous gas phase (increases the trapped gas saturation) and contributes a natural pressure-maintenance function [339,698].

### 11.2.2

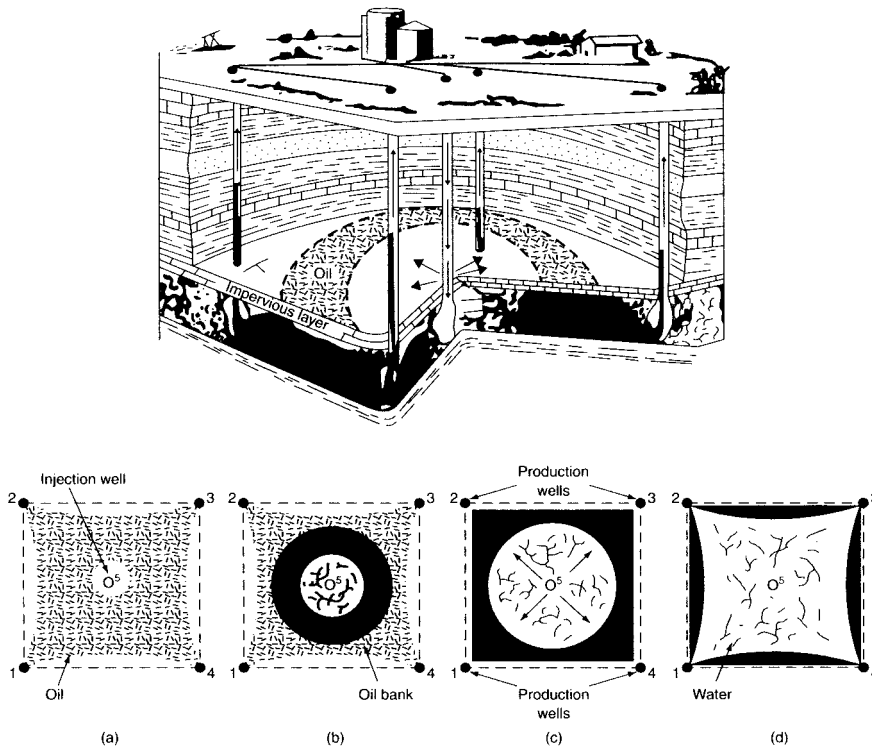
#### **Enhanced (Tertiary) Oil Recovery**

As introduced in the previous section, primary and secondary (waterflooding) production from a reservoir can only recover about 35% (world average) of the original oil-in-place. Figures 11.3 and 11.4 show how water or other fluid can be injected to increase oil recovery. The waterflood residual oil is left in the form of oil ganglia trapped in the larger pores (in water-wet reservoirs) where the viscous forces of the driving waterflood could not completely overcome the capillary forces holding the oil in place. To recover additional oil requires increasing the capillary number



**Figure 11.3** Illustration of the displacement of oil in a petroleum reservoir by chemical flooding. From Sharma [235]. Copyright 1991, Plenum Press.

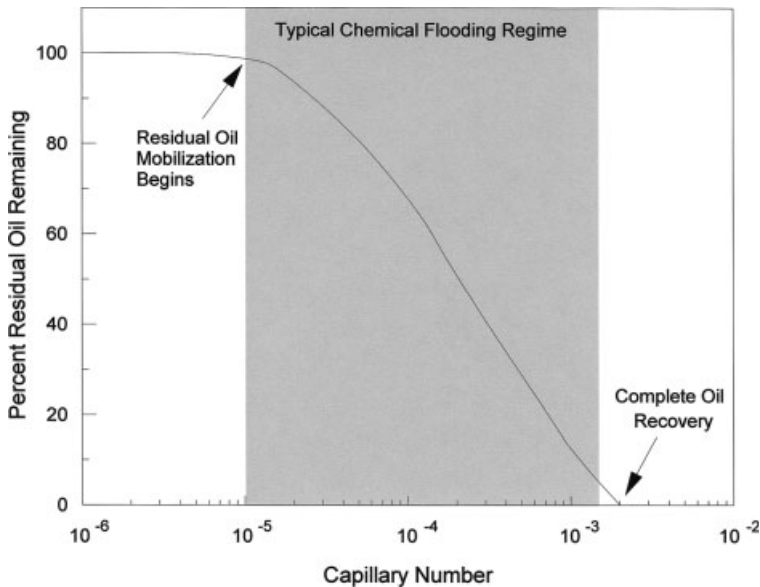
Displacement of oil in petroleum reservoirs by water or chemical flooding (five-spot pattern)



**Figure 11.4** Displacement of oil in petroleum reservoirs by water or chemical flooding using a five-spot pattern. From Ling *et. al.* [223]. Copyright 1987, Royal Society of Chemistry.



(Eq. (11.2)) by several orders of magnitude. Although in principle this can be done by raising the viscous forces, i.e., viscosity and velocity, this is not a practical way to achieve an order-of-magnitude increase. Tertiary (enhanced) oil recovery involves reducing the capillary forces restraining the oil and/or altering viscosities in order to modify the viscous forces being applied to drive oil out of the pores. The addition of a suitable surfactant to the water can decrease the interfacial tension from, for example, 20 mN/m to  $4 \times 10^{-3}$  mN/m, increasing the capillary number to  $5 \times 10^{-3}$ , and reducing the residual oil saturation to 25 % (see Figure 11.5). Table 11.2 further illustrates the effects on incremental oil recovery that can be obtained by changing the composition of injected solution.



**Figure 11.5** Illustration of oil mobilization and recovery due to capillary numbers achieved during chemical flooding.

It may also be beneficial to alter the wettability (see Section 3.5.3) of the reservoir rock, particularly in order to shift oil-wetting regions towards neutral wetting, which is probably about the optimum for improved oil recovery [158]. Figure 3.23 (see Section 3.5.3) shows how surfactant adsorption can alter wettability, but not always in a simple manner. Such surfactant-induced wettability alteration might be considered for predominantly oil-wetting reservoirs such as chalk reservoirs in the North Sea.

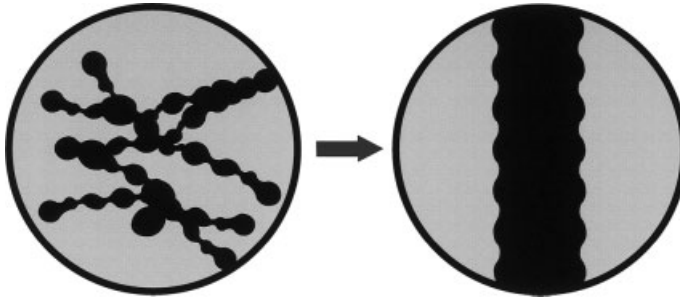
**Table 11.2** Illustration of the effect of changing the composition of injected solution on incremental oil recovery in an enhanced oil-recovery process.\*

Property	Composition of injected solution				
	Water	Polymer	Alkali	Alkali/ Surfactant	A/S/P Alkali/Surfactant/ Polymer
Flow velocity (cm/s)	$3 \times 10^{-4}$	$3 \times 10^{-4}$	$3 \times 10^{-4}$	$3 \times 10^{-4}$	$3 \times 10^{-4}$
Solution viscosity (mPa·s)	1.0	30	1.0	1.0	30
Interfacial tension (mN/m)	30	30	0.1	0.03	0.03
Capillary number	$1.0 \times 10^{-7}$	$3.0 \times 10^{-6}$	$3.0 \times 10^{-5}$	$1.0 \times 10^{-4}$	$3.0 \times 10^{-3}$
Residual oil remaining after waterflooding (%)	100	99	88	67	1
Incremental oil recovery (%)	0	1	12	33	99

\* Assuming a typical oil reservoir containing medium heavy crude oil and employing a reservoir flow rate of 0.26 m/day. The solution viscosity could be increased to 30 mPa·s by adding about 1000 µg/ml (0.1%) partially hydrolyzed polyacrylamide polymer (at pH 8.5). The interfacial tension could be reduced to 0.1 mN/m by adding 1% sodium carbonate, which reacts with the crude oil to produce natural surfactant. The interfacial tension could be further reduced to 0.03 mN/m by adding 0.1% ethoxylated alcohol sulfate cosurfactant.

### Chemical, Microemulsion, and Macroemulsion Flooding

Chemical flooding involves the injection of a surfactant solution which can cause oil/aqueous interfacial tension to drop from about 30 mN/m to near-zero values, on the order of  $10^{-3}$  –  $10^{-4}$  mN/m, allowing spontaneous or nearly-spontaneous emulsification of the oil, an increase in the capillary number by several orders of magnitude, and greatly increased displacement and recovery of the oil [2,5,133,229,235, 421,699–706]. The micelles present also help to solubilize the released oil droplets, hence this process is sometimes referred to as micellar flooding. Having mobilized the oil, these processes are even more efficient if the oil droplets are able to coalesce into a continuous oil bank [227,229,234]. In this case the oil bank is then displaced to a producing well (see Figures 11.6 and 11.3) [234]. Sharma [707] and others [229,659,708] have reviewed the kinds of surfactants used for enhanced oil-recovery processes. For medium-to-heavy crude oils, some of the surfactant involved can be generated from the oil *in situ* through reaction with an alkali, such as sodium carbonate [709]. Polymer is usually added as well, to increase the viscosity of the displacing fluid, which produces improved sweep efficiency. Thus in general, chemical flooding involves the injection of an alkali/surfactant/polymer mixture [227,710]. In microemulsion flooding a co-surfactant will be added as well (see Section 3.8). The optimum surfactant formulation for a microemulsion system is dependent on many variables (i.e., pH, salinity, temperature, etc.) [235,706,711]. Table 11.3 lists some of the components in a typical formulation. The exact kind of emulsions formed in the reservoir can be quite variable, ranging from fine macroemulsions, as in alkali/sur-



**Figure 11.6** Illustration of flowing oil ganglia, in water-wet porous media, coalescing to form a continuous oil bank.

factant/polymer flooding [227,235], to multiple emulsions [97], to microemulsions [711–713]. Although able to produce an efficient oil displacement, chemical flooding has developed slowly because of its complex technology and higher costs. Nevertheless, numerous field pilot tests have been reported [227,714,715], some of which have achieved recoveries of two-thirds of the waterflood residual oil [716,717].

**Table 11.3** Components of microemulsions for enhanced oil recovery.

Component	Composition
Oil	Crude oil or white oil
Brine	Formation water or water from sea, lakes, and rivers with variable saline conditions and concentrations (mg/L to g/L)
Chemicals	Primary surfactant (e.g., petroleum sulfonate) Co-surfactant/co-solvent (e.g., C <sub>3</sub> to C <sub>5</sub> alcohol) Polymer (e.g., xanthan) Alkaline agents (e.g., sodium carbonate) Bactericides (e.g., formaldehyde) Sacrificial adsorption agents

Some emerging applications involve the use of macroemulsions, as opposed to the microemulsions just discussed. These emulsions would be injected or produced *in situ*, either for blocking and diverting, or for improved mobility control [2,5,227]. Broz *et al.* [718] and French *et al.* [719] have proposed the use of oil-in-water emulsions for blocking and diverting of injected steam. There is some evidence to suggest that improved mobility control can result from the *in situ* formation of heavy water-in-oil emulsions, such as during cyclic steam stimulation [720]. Sarma and Maini [721] have suggested emulsified solvent flooding as an alternative to hydrocarbon or CO<sub>2</sub> miscible displacement of heavy oil from thin reservoirs. In this case one would be able both to improve sweep efficiency (reduce fingering) and to significantly reduce the amount of solvent needed for a flood by injecting it in the form of a solvent-in-water emulsion.

### Foam Injection Processes

Foams can be injected into a reservoir for mobility control or for blocking and diverting. For example, in a gas flooding process, injecting the gas as a foam lowers the gas mobility and diverts at least some of the gas into parts of the reservoir formation that would otherwise remain unswept (or underswept) due to channelling or gravity override. Such diverting action produces increased oil recovery. Since foam mobility tends to be reduced disproportionately more in higher permeability zones, improvement in both vertical and horizontal sweep efficiency can be achieved. Suitable foams can be formulated for injection with air/nitrogen [345,722–724], hydrocarbon gas [345,725–728], carbon dioxide [345,729,730], or steam [345,731–733].

A major challenge is the proper selection of foam-forming surfactants. Table 11.4 lists some of the characteristics that are needed for a foaming agent to be effective in porous media under petroleum reservoir conditions. For more information see Refs. [306,310,345,659]. The economics of foamflooding are determined to a large degree by the amount of surfactant required to generate and propagate a foam. Surfactant loss through partitioning into the crude-oil phase and through adsorption on the rock surfaces cannot be completely eliminated, and these are therefore important (but undesirable) mechanisms of surfactant loss. For the very hydrophilic surfactants chosen for many foamflooding applications, the partitioning into crude oil can be low. More serious are the adsorption losses for foam-flooding surfactants, which can be as high as 2.5 mg/g [734–736]. This can lead to vastly reduced distances of foam propagation in a reservoir, so selection of a surfactant formulation with acceptable adsorption levels under the reservoir conditions specific to a particular application, is crucial. Surfactant adsorption in reservoirs is reviewed in more detail elsewhere [735,737,738].

**Table 11.4** Some characteristics needed for a foaming agent to be effective in porous media under petroleum reservoir conditions [4].

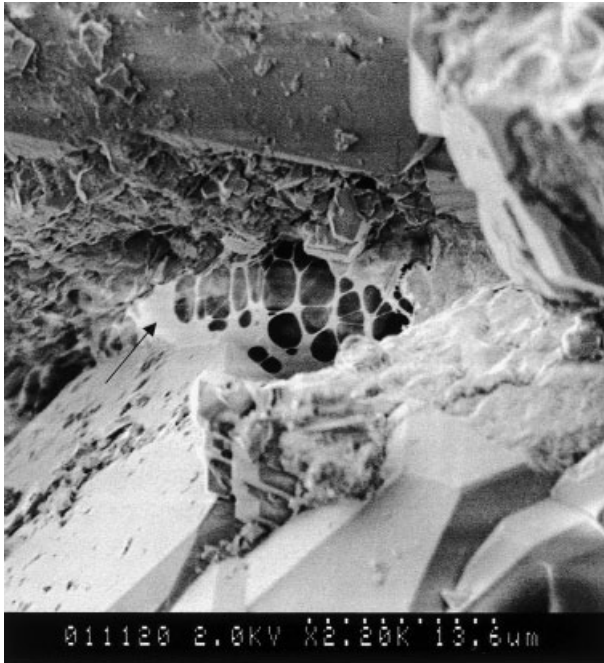
Good solubility in the brine at surface and reservoir conditions
Good thermal stability under reservoir conditions
Low adsorption onto the reservoir rock
Low partitioning into the crude-oil phase
Strong ability to promote and stabilize foam lamellae
Strong ability of the foam to reduce gas mobility in porous media
Good tolerance of the foam to interaction with crude oil in porous media

Results from field testing have suggested that foams may achieve lower gas mobility reductions than anticipated due to the defoaming action of residual crude oil [739], which has led to an interest in the formulation of oil tolerant foams. Although crude oils tend to act as defoamers, it turns out that foams actually exhibit a wide range of sensitivities to the presence of crude oils, as discussed in Section 5.6.7. Overall, it is clearly possible to make foams that are reasonably stable in the presence of light through heavy crude oils [307], using either relatively pure foaming agents (usually quite expensive), or else with specially formulated mixtures, which

can be cost-competitive with traditional foaming agents (e.g., [740,741]). Some of these foams, intended for mobility control, can even improve microscopic displacement, by emulsifying oil into droplets that are small enough to permit their passage inside the foam's lamellar structure, and thus contribute an incremental oil recovery [307,341,348,741].

Reservoir-foam applications may involve slug injection, in which foaming surfactant solution is injected into the gas stream at the well-head over a period of a few hours, semi-continuous injection, in which surfactant solution is injected at intervals over a period of a day or so, and continuous injection, in which surfactant solution is injected continuously for months or even years. Recently, much attention has been paid to near-well applications of foams [345,726–728].

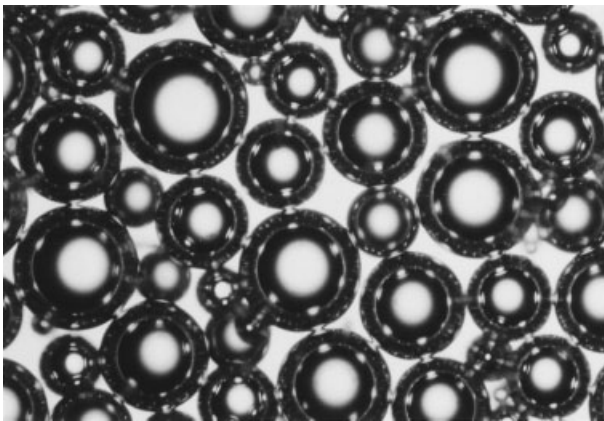
Polymer-enhanced (thickened) and gelling foams are also increasingly being used in the petroleum industry. Incorporating polymers into foaming solutions increases foam viscosity and also stability [742–751]. This suggests that polymer-thickened foams, with their enhanced viscosities and stability, could be effective mobility-control agents [743,752,753]. A range of polymer additives have been tested, including polyacrylamide, polyvinyl alcohol, polyvinylpyrrolidone, and xanthan biopolymers. In addition to changing foam quality and texture, the effective viscosities of polymer-thickened foams can also be adjusted by varying the polymer concentration and



**Figure 11.7** Photomicrograph of gelled-foam lamellae (see arrow) stretching across a pore in Berea sandstone rock, showing films, rods, and intermediate structures. From Schramm and Kutay [71] Copyright 2004, The Petroleum Society.

molar mass. In general, polymer-thickened foams are shear-thinning. Gelling foams, i.e., polymer-thickened foams to which time-delayed cross-linking agents have been added, can be used to block swept zones and to divert fluids into under-swept zones in reservoirs containing large permeability variations and/or fractures [754–756]. Once gelled, these foams can function in a similar fashion to conventional gels, but with only a small fraction of the pore space being occupied by gelled liquid. Figure 11.7 shows a photomicrograph of gelled-foam lamellae spanning a pore in a Berea sandstone rock, showing films, rods, and intermediate structures. As is the case for *in situ* processes involving surfactants, those involving polymers are adversely affected by the adsorption of polymer onto rock and mineral surfaces, which can lead to vastly reduced distances of polymer propagation in a reservoir. Polymer adsorption in reservoirs is reviewed in more detail elsewhere [757].

Finally, there is another class of foams, namely micro-foam, or colloidal gas aphrons. These terms refer to a dispersion of aggregates of very small foam bubbles in aqueous solution. They can be formed by dispersing gas into surfactant solution under conditions of very high shear [111–113] creating very small gas bubbles (bubble diameters  $\approx 50\text{--}300\ \mu\text{m}$ ), each surrounded by a bimolecular film of stabilizing surfactant molecules. Figure 11.8 shows an example of a micro-foam. There is some evidence that such micro-foams tend to be more stable than comparable foams that do not contain the bimolecular film structure [111–113]. Other claims for special properties have been made [494–500], but are less well supported, or even conflicting within the literature. Micro-foam injection for reservoir oil recovery has been reported in the literature [499,500], as has micro-foam flushing for soil remediation [494–498]. The literature to date contains conflicting claims regarding the physical properties of these foams, so the results should be interpreted with caution pending additional independent studies. Micro-foams may find useful application in future reservoir oil-recovery processes.



**Figure 11.8** Photomicrograph of a micro-foam. The bubble diameters are in the range 30 to 150  $\mu\text{m}$ .

### 11.3

#### Surface Operations

##### 11.3.1

#### Surface Treatment

Any kind of dispersion that was useful in the reservoir may be, or may become, an undesirable dispersion when produced at a well-head. This could include used drilling fluid that has returned to the surface, conventional oil production that occurs in the form of a W/O emulsion, or foam from an enhanced oil-recovery process. These can present some immediate handling, process control, and storage problems. In addition, pipeline and refinery specifications place severe limitations on the water, solids, and salt contents of oil they will accept in order to avoid corrosion, catalyst poisoning, and process-upset problems. For pipeline transportation, an oil must usually contain less than 0.5% basic sediment and water (BS&W).

Both W/O and O/W emulsions are commonly produced at well-heads during primary, secondary, and tertiary oil production. These emulsions may have been formed in the reservoir, or at the face of the well-bore itself. A typical W/O petroleum emulsion from a production well might contain 60–70% water. Some of this, the free water, will readily settle out. The rest, often in the form of droplets stabilized by a viscoelastic interfacial film formed from the asphaltene and resin fractions of the crude oil, requires a demulsifying treatment, the specific nature of which can be highly variable [2,758]. It is often held that each oilfield location produces a unique kind of emulsion requiring a customized treatment. A variety of physical methods are used in emulsion breaking, all of which are designed to accelerate coagulation and coalescence. For example, oilfield W/O emulsions may be treated by some or all of settling, heating, electrical dehydration, chemical treatment, centrifugation and filtration [99,482]. The produced water in an oilfield typically contains emulsified oil at levels of a few hundred to a few thousand mg/L [481]. The oil in these produced O/W emulsions must be removed in order to reuse this water, or to dispose of it [481]. The oil is usually separated by some combination of skim tanks, filters, induced gas flotation (IGF) cells, centrifuges, and hydrocyclones [99].

In many surface-separation processes, there will occur three distinct phases or process streams: a product stream (either oil or water), a waste (tailings) stream, and an interface or “rag layer” emulsion stream, which may contain emulsified oil and/or water. The interface emulsion can be the most troublesome, in terms of process operation, and the most complex and intractable, in terms of treatment. Mikula shows (Figure 1 in Ref. [66]) a photomicrograph of a quite stable interface emulsion (rag-layer emulsion) in which one can clearly observe the simultaneous occurrences of both O/W and W/O emulsions in different regions of the same sample.

Demulsifying agents are usually added to the continuous phase and need to diffuse to the interface and displace, or otherwise destroy, the effectiveness of the original stabilizing agents at the interfaces. The demulsifier should usually be added far enough upstream to permit these actions to take place, and for droplet coalescence to occur, before the emulsion reaches a separating vessel. Demulsifiers are formu-

lated to provide specific properties including hydrophile–lipophile balance (HLB), solubility, rate of diffusion into the interface, and effectiveness at destabilizing the interface [452,470]. To determine the best demulsifier for a given emulsion, a series of bottle tests are usually conducted. As discussed in Section 5.6.7, a wide range of demulsifying agents are used.

Foams produced at a well-head are usually undesirable. When a foam drilling fluid is brought to the surface, defoaming is needed to prevent overfoaming of the pit or tank. This can be accomplished by adding a defoamer, such as a polydimethylsiloxane, [327,659]. In primary oil production, oil flows under its own pressure, through permeable porous rock formations, to a production well. When oil nears and enters the annulus of a production well, it experiences a decreased system pressure, dissolved gas may come out of solution, and the oil may foam. In surface emulsion treaters (e.g., oil–water separators) the occurrence of foams is generally undesirable and any such foams will have to be broken, either down-hole or at the surface [3,46]. Oilfield-produced water may also foam, which can also cause problems in handling and in gas separation. This is usually dealt with by adding anti-foaming or defoaming chemicals such as silicones or polyglycol esters. In the non-thermal production of heavy oil, however, foaming of the oil is thought to improve production, as discussed in Section 11.2.1.

Suspensions of silica and other minerals are also produced, together with crude oil at well-heads. Suspended solids are managed differently depending on the nature of the reservoir and the co-produced fluids. Solids produced from conventional oil and gas reservoirs can have adverse effects on both well productivity and well equipment. Therefore, operators usually focus on the prevention or control of solids production through the use of screens or gravel packs, typically keeping the concentration of produced solids below 0.06% [697]. Solids produced from heavy-oil bearing, unconsolidated, reservoirs is different because the production of large amounts of solids is actually necessary to maintain good well productivity. In this case, operators need special pumping systems capable of handling suspensions with a high solids loading, sometimes greater than 50% solids [697]. In any reservoir, for which long horizontal wells are used, special tools and techniques are used to remove deposited solids. Finally, the production of petroleum fluids bearing suspended solids necessitates a series of surface separation, cleaning, and disposal techniques, especially where environmental considerations require that the disposed solids be oil-free. See Ref. [4].

One kind of surface emulsion that is desirable is the Orinoco bitumen emulsion produced from *in situ* steam stimulation and recovery in the Orinoco River deposit in Venezuela. This emulsion is reformulated into Orimulsion<sup>®</sup>, an O/W emulsion, containing about 30% fresh water and a stabilizing surfactant (typically about 0.1 percent each of monoethanolamine and an alcohol ethoxylate) [588,759,760]. The O/W emulsion has a viscosity of about 450 mPa·s (30 °C, 100 s<sup>-1</sup>) compared with the original bitumen viscosity of about 10 000 mPa·s [760,761]. This emulsion can be used as an alternative fuel for power-generating plants. Being water-continuous the emulsion is easily handled and transported, but otherwise behaves similarly to fuel oil.



## 11.3.2

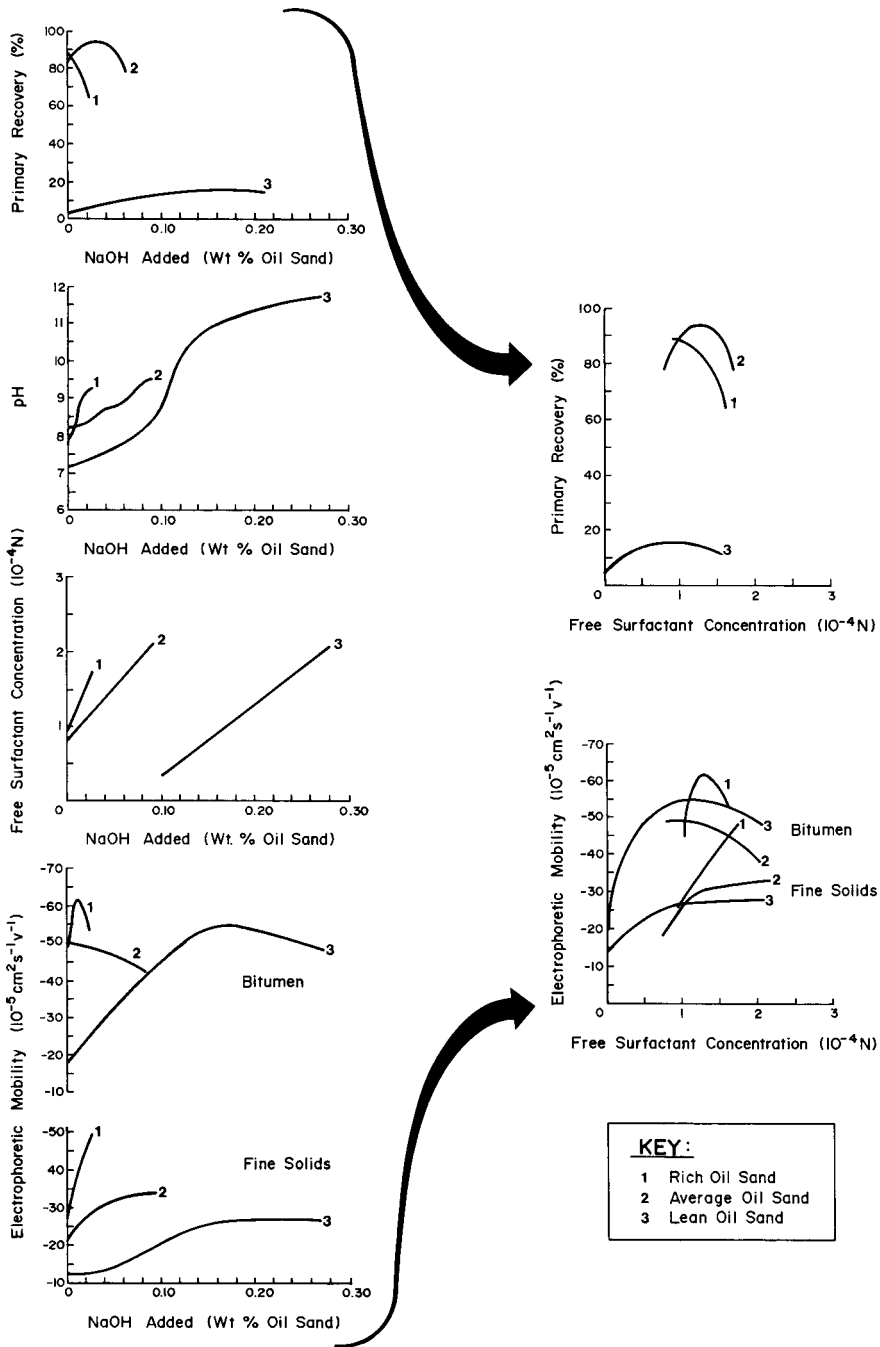
**Oil Sands Processing**

The large Canadian oil-sands surface-mining and water-based flotation processing operations involve a number of kinds of emulsions and foams in a variety of process steps. Whereas mineral ore flotation relies on wettability alteration and bubble attachment, oil and bitumen flotation rely more on attachment and filming to create an oleic foam.

Bitumen is separated from the oil sand matrix, in large tumblers, where surfactants play key roles in separating bitumen from mineral particles and then floating the former. As reviewed elsewhere [5,98] alkaline conditions are used to produce (saponify) from the bitumen a class of natural surfactants that are predominantly aliphatic carboxylates of chain length typically  $C_{15}$ – $C_{17}$ , and also aliphatic sulfonates with chain lengths greater than  $C_5$ . These surfactants adsorb at surfaces and interfaces, increasing their electric charge, and the increased disjoining pressure helps drive disengagement of the oil from the solids. This creates an oil-in-water (O/W) emulsion containing not just oil and water, but also dispersed solids and gas. The surface electric charge also helps prevent attachment of the released and emulsified droplets to co-dispersed solid particles such as clays [270]. In fact, the optimal processing condition correlates with maximizing the negative charge, or zeta potential, on the droplets [249,762]. Figure 11.9 provides an illustration [250], and shows that the maximum (negative) emulsion droplet zeta potential achieved was about  $-35$  mV [249,762] which is consistent with the “good stability” guideline set out in Section 5.2.2.

The adsorbed surfactants also reduce surface tensions, causing spontaneous filming of the oil over gas bubbles which drives the flotation [5,98,145,270,642]. The flotation medium is a suspension of particles whose viscosity must be sufficiently low to allow aerated bitumen globules to float (cream) at a practical rate. In addition solids-bubble attachment needs to be prevented. Accordingly, the nature and properties of the particle suspensions can have a significant influence on process efficiency [270,350]. Successful flotation leads to the formation of an oleic foam (bituminous froth) that is recovered by skimming [5,98]. In addition to oil and gas, the froth contains emulsified water and some dispersed solids. The froth has to be broken in order to permit pumping and subsequent removal of entrained water and solids before the bitumen can be upgraded to synthetic crude oil [5,98]. This is facilitated by de-aeration and dilution with naphtha. The diluted froth contains multiple emulsion types including tenacious multiple emulsions [95] which complicate the downstream separation processes. These aspects are discussed elsewhere [98,270,642].

A consequence of the application of flotation technology to oil sands bitumen production is the co-production of tailings suspensions, consisting of fine silica and clays plus some residual emulsified bitumen. This is discussed in somewhat more general terms in Section 10.4. See also Refs. [638,642].



**Figure 11.9** Illustration of the connection between hot water flotation efficiency and measured chemical and physical properties, including bitumen zeta potential From Schramm and Smith [250]. Copyright 1987, Canadian Society for Chemical Engineering.

## 11.3.3

**Pipeline Transportation**

Some emulsions are made to reduce viscosity so that an oil can be made to flow. An example is the concentrated oil-in-water emulsions that are made from heavy oils and intended for economic pipeline transportation over large distances [709,763,764]. Another example is the oil produced at off-shore drill sites in the form of oil-in-water emulsions (containing reservoir water) which may have to be transported to an on-shore processing centre, at which the primary emulsion is separated into its components, after which the oil may be re-emulsified (using fresh water) for other applications. Advantages include avoiding the use of diluents or heat which would otherwise be needed to reduce the oil viscosity sufficiently for pumping through the pipeline. Here the emulsions have to be surfactant-stabilized so that they will be stable during transport (but not too stable as they will have to be broken at the end of the pipeline). Both synthetic [759,760,763] and natural surfactants [709] have been used. The emulsions also need to be stable under static conditions as well as flowing conditions so that, should a pipeline be shut-down for a period of time, the emulsion will not completely break, with consequent phase separation and increased pressure drop.

A key operating parameter is pressure drop across the pipeline, for which a knowledge of the emulsion's rheological properties is needed. Although use may be made of batch rheological measurements (Section 6.2), the final data for scale-up is usually obtained from viscosities determined in a pilot plant, involving large batches of the prospective emulsion that are made to flow in a pipeline loop. The smallest size of pipeline loop, usually considered for measurements intended for industrial scale-up, is one inch (2.54 cm) inside diameter [763]. The results are used to determine laminar versus turbulent flow regimes and as input in flow models [763]. Nasr-El-Din [85,86] reviews the methods used to predict pressure drops across emulsions flowing in pipelines, as well as those used to sample and measure oil and solids concentration in pipelines.

Several practical formulae have been developed for estimating the effect on emulsion viscosity of changes in key variables such as temperature, water content, and droplet size distribution, in which adjusting factors for each property are obtained from empirical correlations. An illustration is provided by Rimmer *et al.* [763]. Such formulae may also contain a term representing changes in emulsion droplet size due to droplet coalescence that occurs with time as the emulsion moves through the pipeline ("ageing").

Once a transportation emulsion reaches its destination, it has to be broken. The demulsification techniques used are similar to those discussed in Section 7.2.1, and typically include any or all of: raising the temperature of the emulsion, adding demulsifiers, and adding diluents.

## 11.3.4

**Upgraders and Refineries**

If emulsions were used for the transportation by pipeline of a heavy oil to an upgrader or refinery then, when received, these emulsions will have to be broken and the water removed, which otherwise would cause operating problems. Even if emulsion transportation was not used, there will still be some emulsified water component in the oil, with the aqueous phase probably containing a high salinity (reflecting the formation water in the reservoir from which it came). The upgrader or refinery will need both the salts and the water to be removed. The first step is usually to treat the incoming oil stream in a de-salter, which can be as simple as “washing” the oil with fresh water. This creates an emulsion, or an additional emulsion, so the next steps are emulsion breaking and separation. The emulsion breaking and separation may be accomplished using any of the vessels listed in Section 7.2, including de-salting (sedimentation) vessels, heater/treaters, or electrostatic separators [452,765]. As with all emulsion treatments, demulsifying chemicals may have to be added to achieve a sufficiently high degree of separation within the residence time of the treating vessels(s). Refineries may need to reduce the water contents of light crude oil to  $\leq 0.2\%$  and that in heavy crude oils to  $\leq 0.4\%$  [452].

In both upgraders and refineries, the de-salted oil is later subjected to coking (high-temperature thermal conversion of heavy fractions to lighter products), and a series of distillation steps (that are used to separate out the various oil fractions). The occurrence of foams in both kinds of vessels is always undesirable, since it causes operating instabilities and foam-over, and any such foams will have to be broken. Ironically, some of the foaming agents responsible for these problems are corrosion inhibitors, demulsifiers, and solids dispersants that had been added upstream to prevent other kinds of operating problems. As a result, antifoaming and defoaming can involve counteracting the effects of foaming agents that occur naturally in the crude oil and also those that have been added during prior processing. A review of refinery foam occurrences and treatment is given by Lewis and Minyard [765]. Kerner [327] describes several hundred different formulations for foam inhibitors and foam breakers. Commonly used antifoams include hydrophobic silicas (hydrophobic silica particles), silicone oils (poly(dimethylsiloxane)s), and glycols (such as poly(propylene glycol)s) [765].



## 12

# Manufacturing and Materials Science Applications

### 12.1

#### Introduction

A range of emulsions, foams and suspensions can be found in the manufacturing/ value-added process industries. Some examples are given in Table 12.1. Examples for related areas can be found in Tables 9.1 (environment), 10.1 (minerals), and 11.1 (petroleum).

**Table 12.1** Some emulsions, foams, and suspensions in manufacturing and material science\*.

Emulsions	Asphalt (paving) emulsion	O/W
	Aqueous polymer-type paints	O/W
	Microemulsion metalworking oil	O/W
Foams	Wood fibre brownstock foams	G/W
	Flotation de-inking froth	G/W
	Textile dye foam	G/W
	Detergent washing foam	G/W
	Fire-fighting foams	G/W
Suspensions	Cellulose fibre pulp slurries	S/W
	De-inking pulp slurries	S/W
	Pigment-containing paints	S/L
	India ink	S/W

\* Dispersion abbreviations include liquid (L), water (W), oil (O), gas (G), and solids (S).

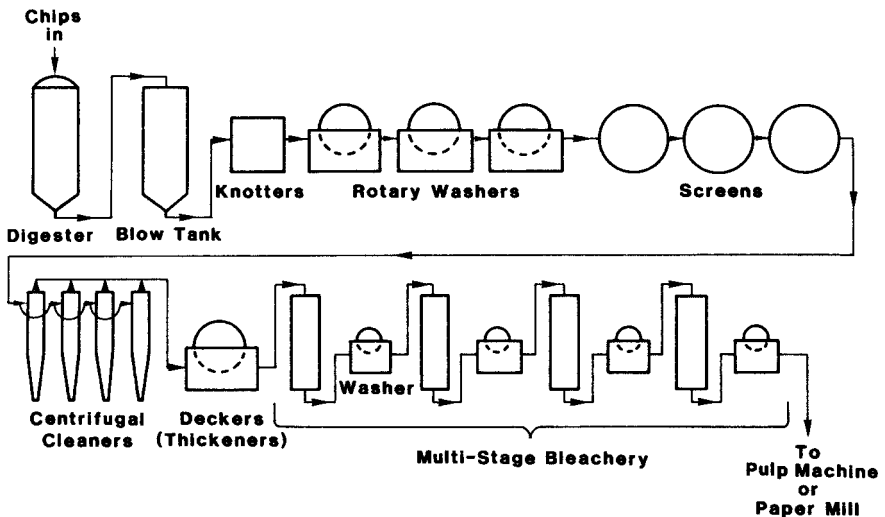
### 12.2

#### Papermaking

Cellulose fibres are typically 20–40  $\mu\text{m}$  wide by about 1–4 mm long [766]. They tend to be negatively charged due to the presence of surface carboxylate and hydroxyl groups [551]. This makes them hydrophilic, so they absorb water and are quite easy to stabilize in aqueous suspension due to electrostatic repulsion.

The natural stability of cellulose fibre dispersions in water can hinder the aggregation and collection of cellulose wood fibres in paper-making machines. Chemical pulping involves the use of acidic (sulfurous acid) or alkaline (kraft, sodium hydroxide/sodium sulfide) solutions to degrade and dissolve the lignin and allow the cellulose fibres to be separated, washed, and possibly bleached [551,766–768]. After kraft cooking, the degradation products, called kraft lignin, are dissolved and dispersed in the liquor, adsorbed on the cellulose, and trapped in fibre cell walls giving them a brown colour [769]. Brownstock washing involves separating as much lignin as possible from the pulp (see Figure 12.1). The retention of pulp fines and fibres can be maximized when the surface electric charge is minimized. This can be monitored at several stages of the process using zeta potential measurements [770]. The naturally negative surface charge is usually reduced by adding cationic polymers or polyelectrolytes, and/or alum. Mill tests have shown that reductions in zeta potential from about  $-13$  mV to about  $-8$  mV can increase single-pass fibre retention efficiency by about 15% [771]. In addition to maximizing fibre collection efficiency for paper making, this reduces the amount of sludge produced by the wastewater treatment facility and reduces the load on the white water recycle systems.

Defoamers are needed in brownstock washing to prevent overflow from the washing drums, and also because the foam makes the washing process itself less efficient [772]. The foam is caused by natural surfactants extracted from the wood chips and/or from surfactants added during the processing of the chips [772]. The defoamers may be added at any appropriate stage in advance of the washing tanks. Originally substances such as milk, cream, kerosene, and fuel oil were used for this purpose [769,772]. These have now been supplanted by modern O/W emulsion defoamers such as “brownstock defoamer”, in which the oil phase is a carrier oil (such as a



**Figure 12.1** Illustration of the process steps in kraft pulp mill bleaching. The arrows indicate the flow of pulp. From Allen *et al.* [772]. Copyright 1993, Marcel Dekker.

mineral oil) containing suspended foam-breaking particles (such as hydrophobic silica and/or waxes) [769,772].

A related application in papermaking is the de-inking of fibres from, for example, waste papers of various kinds. This is described in Section 12.5.2.

The mill effluents need to be treated to remove the suspended solids. Sedimentation and/or dissolved air flotation, as discussed in Section 9.4, are commonly used for solids removal from pulp and paper-mill effluents [551].

The natural hydrophilic nature of cellulose fibres becomes an advantage again when wet fibres are brought together during a sheet-forming operation. Here the aim is to have filler particles and fibre fines aggregated with or adsorbed onto the larger fibres without having the large fibres themselves become flocculated [551]. The oriented large fibres become attracted through hydrogen bonding among adsorbed water molecules on adjacent fibres. As the water is removed from the fibres this bonding evolves toward hydrogen bonding among the fibres themselves, through their surface hydroxyl groups [551]. Particle aggregation control allows the process to be optimized to produce the best fibre retention, drainage, sheet formation, and sheet properties. A further aspect of particle aggregation control comes into the preparation of pigment dispersions for use in papermaking. Kaolinite is used as a white pigment for this purpose, and suitable dispersions are prepared by deflocculating the natural clay with alkali phosphates or silicates [766]. Titanium dioxide (as anatase and/or rutile) is used as a coating to contribute opacity and brightness. Dispersions of up to about 70% solids content are made with high-energy grinding mills and dispersants such as polyphosphates [766].

### 12.3

#### Emulsions for Road Paving

Asphalt is a semi-solid variety of bitumen having a (low shear) viscosity of about [773]:

- $10^4$ – $10^5$  Pa·s at 25 °C,
- $10^6$ – $10^7$  Pa·s at 5 °C, and
- $10^7$ – $10^8$  Pa·s at 0 °C.

The bitumen comes as a residue from the refining of conventional or heavy crude oil, or from natural deposits of oil (tar) sand. Bitumen, being a complex mixture of more than 1000 different molecules, is itself a colloidal suspension of asphaltenes in a continuous phase of saturated paraffins, aromatic oils and resins [774]. Descriptions of different kinds of asphalts are given in Refs. [775,776]. At low asphaltene concentration the suspension is Newtonian. Once the concentration increases above about 8 % v/v, however, the asphaltenes form a three-dimensional network and the suspension can become a viscoelastic gel [774]. The asphaltenes interact through van der Waals forces so that a bitumen containing 15% asphaltenes is solid at room temperature and liquid above about 60–100 °C.



Asphalt emulsions are used in road paving for the production of a smooth, water-repellant surface. First, an asphalt O/W emulsion is formulated which has sufficiently low viscosity to be easy to handle and apply, and which has sufficient stability to survive transportation, brief periods of storage, and the application process itself. The emulsion needs to be able to shear thinly during application, and then break quickly. An additional advantage of the emulsion over asphalt alone lies in its ability to be applied to wet gravel or rock [37,777]. Emulsified asphalts can be characterized by their stability, or lack thereof, when applied to aggregate [776]. “Rapid-setting” asphalt emulsions break as soon as applied to the aggregate, “medium-setting” emulsions break only when mixed with the aggregate (due to the combined actions of dust particles and shear), and “slow-setting” emulsions break only when sufficient water has evaporated. Medium-setting asphalt emulsions are used for road patching [776]. A series of customized tests have been developed for determining the stability of asphalt emulsions to breaking when applied to aggregate surfaces [776].

A typical asphalt emulsion might contain 40–70% bitumen, having droplet sizes in the range 1–20  $\mu\text{m}$ . The inversion point for asphalt emulsions is usually in the range 80–90% asphalt [778]. The asphalt emulsions can be stabilized either by natural naphthenic surfactants released by treatment with alkali (for a somewhat similar situation, see also Section 11.3.2), or else by the addition of synthetic anionic surfactant, but more commonly cationic surfactants are used [193,777]. The surfactants need to reduce interfacial tension and help stabilize the O/W emulsion. Ideally, the surfactants should also adsorb and make the road-building solids (aggregate) hydrophobic so that the latter will be preferentially wetted by the liquid asphalt droplets. The latter is promoted by using cationic surfactants, such as quaternary amines, which are strongly attracted to the negatively charged aggregate particles [37]. The surfactant adsorption, hence depletion from the emulsion, promotes breaking of the emulsion itself when it contacts the aggregate. In fact, the largest difference between rapid, medium and slow-setting emulsions, lies in the nature of the surfactants used in their formulation. Anionic surfactants tend to be used for asphalts that will be applied to positively charged aggregates, like limestone and dolomite, whereas cationic surfactants tend to be used for asphalts that will be applied to negatively charged aggregates, like silicates [776].

In addition to road paving, asphalt has also been used for covering roofs and floors, as the binder between some kinds of bricks, and for insulation.

## 12.4

### Metal-working

Metal-working fluids provide lubricity and cooling during the various metal-working and metal-cutting operations. Greases also have to be formulated to exhibit a significant yield stress since they are intended to flow into tight spaces when injected under pressure and then remain in place. These fluids were traditionally petroleum oils to which surfactants were added to increase their lubricating and wetting abil-

ities. An example of such a grease is a gelled solution of relatively short-chain surfactant, such as lithium 12-hydroxy stearate in mineral oil [629]. Here, the surfactant molecules aggregate into a lamellar phase (with the polar groups facing inwards) of long fibres that in turn provide the macromolecular strands needed to form the gel. Prost and Rondelez provide an electron micrograph image of these strands (Figure 2 in [774]). The lamellar fibre structures maximize van der Waals interactions among the surfactant molecules, while screening the polar head groups from the mineral oil [774]. The associations between fibrous clusters, the length of thread-like surfactant strands, and the density of their contact points (cross-links) govern shear-resistance of the grease [629].

Another method used to make lubricating greases, and also oil-based drilling fluids, involves the use of organic compounds to stabilize non-aqueous suspensions. For example, clays and other mineral solids can be dispersed in oils when polar organic compounds such as quaternary ammonium surfactants are adsorbed onto their surfaces, making the latter preferentially oil-wetting (see Sections 3.4 and 3.5.3).

Some more modern semi-synthetic metal-working oils are actually O/W microemulsions [193]. Such microemulsions may switch readily to O/W macroemulsions when diluted with water at the time of application. Once applied, the surfactants need to adsorb onto metal surfaces with their hydrophobic groups oriented away from the surfaces in order to reduce friction and ensure wetting of the metal by hydrocarbons present in the metal-working liquid or emulsion. Rosen and Dahanayake [193] list the commonly used surfactants for this application.

## 12.5 Cleaning Processes

### 12.5.1 Detergency

The principles involved in detergency have been introduced in Section 3.6.6, and are discussed in terms of household, personal care applications in Section 15.2. In a typical industrial cleaning process, an object to be washed is brought into contact with a cleaning solution, or bath, usually with enough solution to both wet (remove air) and cover the object. The entire system is then agitated to provide mechanical shear. The combination of chemical effects (due to the surfactants present) and mechanical effects (due to the shear added) cause the soil or other contaminants to be wetted, removed and dispersed in the cleaning solution. The removed soil has to be held in a stabilized dispersion in order to prevent redeposition. The cleaning solution, carrying the removed and dispersed soil, is then separated by draining, wiping, or some other means. The cleaned object is rinsed and, usually, dried. The criteria for determining whether the object is sufficiently “clean” vary for different applications and different industries. In some cases it may be complete water wettability, in others a certain maximum percentage of soil, while in others it may be the absence

of a certain soil component regardless of the concentration of other soil components.

Detergent formulations may contain a mixture of surfactants aimed at providing detergency, foaming (for hand-washing dish detergent) and emulsifying. In addition, a number of other additives may be used to provide features that are not directly detergent related [206]:

- builders, which support the action of the detergents by, for example, removing hardness ions from solution through sequestration into soluble chelates of a nitrilotriacetic acid such as EDTA (other builders include phosphates, alkalies, silicates, zeolites, and clays);
- antiredeposition agents, such as sodium carboxymethylcellulose;
- bleaching agents, such as sodium perborate or chlorinated phosphates, that can bleach juice and wine stains;
- enzymes, that react to break-up protein-based stains;
- fluorescent whitening agents, which absorb UV radiation and emit blue light, giving a white appearance (such agents are increasingly incorporated into the fabrics themselves, rather than the detergent formulation);
- antimicrobial agents;
- blueing agents, dyes that can promote a white appearance by countering any yellow colouring in materials to be cleaned;
- foam boosters, such as alkanolamides (in hand-dishwashing and shampoo formulations);
- antifoaming agents such as in mechanical cleaning formulations;
- starch.

Practical detergency is influenced by a number of factors including [206]:

- the nature and quantities of the soil and the substrate from which it is to be removed;
- temperature;
- residence time;
- nature and degree of mechanical energy input; and
- rinse conditions.

The effectiveness of detergency can be determined by such techniques as reflectance (for whiteness), soil extraction, visual judgement, and even radiolabelling of soils.

Detergency can be found in a number of industrial settings, including the following.

- Textile cleaning, in which natural fibres like cotton or wool have to be cleaned, often before and after several different processing steps such as spinning and dyeing. Although aqueous detergent systems are very common, some dry-cleaning processes now incorporate surface-active agents in a hydrocarbon or chlorinated-hydrocarbon medium [206].

- Commercial laundry and commercial dishwashing, in which speciality machines may require speciality detergents. Even dry-cleaning may require detergent stain removers.
- Hard-surface, usually metal, cleaning in which very specific kinds of dirt need to be removed, such as grease on engines, rust on metal parts, or burned carbon on cooking surfaces. The detergents may also need to be biocidal, such as blended non-ionic and quarternary amine surfactants.

The same principles that lead to interest in microemulsions for displacing trapped crude oil from pores in reservoir rock also make them potentially useful for industrial cleaning [234].

Each industry tends to have its own standardized test(s) for detergent effectiveness. For example, in the washing of fabrics, whether textile industry or household, one such test method uses a device called a Terg-O-Tometer. This involves a group of 1000 ml sized washing machines in which variables including temperature, agitation, detergent, water hardness, cloth test pieces, and cloth-to-liquid ratio can be controlled [123].

In the manufacturing industry, detergency (the cleaning action provided by alkaline or acid-based surfactant systems) is critical where cleaning is followed by a treatment process such as painting, electroplating, or annealing. This cleaning usually has to include de-greasing and de-rusting. In many cases the freshly cleaned metal surfaces are treated with a corrosion-resistant coating to prevent deterioration [206].

In immersion cleaning, the metal parts to be cleaned are soaked with agitation cleaning solution. This process is quite demanding of the cleaning solution since, although the contact time can be reasonably long, there is not much mechanical energy available in the process, the industrial parts to be cleaned can be heavily soiled, and the cleaning solution may need to be re-used for many cleaning cycles. The surfactant solutions used need to be optimized, following the principles discussed in Section 3.4, to achieve the desired contact angles and emulsifying properties. Non-ionic ethoxylates, possibly mixtures of high and low HLB, in alkaline solution are often used [193]. Acid solutions are used where inorganics need to be removed, e.g., a dodecyl benzene sulfonic acid [193].

In spray cleaning (also called “clean in place”) there is significant mechanical energy input to aid in the cleaning action but the contact time can be very short. Again, the wetting and emulsification properties of the cleaning solution are very important, and in this case the solution needs to be low foaming [123]. For example, “end-capped” non-ionic surfactants used at or near their cloud point can provide these features (the low foaming nature resulting from having the separated phase acts as a defoamer). For heavily soiled surfaces, another non-ionic surfactant may have to be added in order to provide the necessary emulsification and prevent redeposition [193].

In machine-based processes involving detergency foaming is usually not wanted. In drum-type washing machines, for example, higher mechanical shear and greater engulfment of air occur when compared to drum-type washing machines. The drum-type machines therefore create much more foam, which can restrict contact

between items to be washed and the washing solution, and which may also cause foam-over [490]. A wide range of antifoams, including both silicone and non-silicone constituents, has been considered for textile washing applications as reviewed by Ferch and Leonhardt [490].

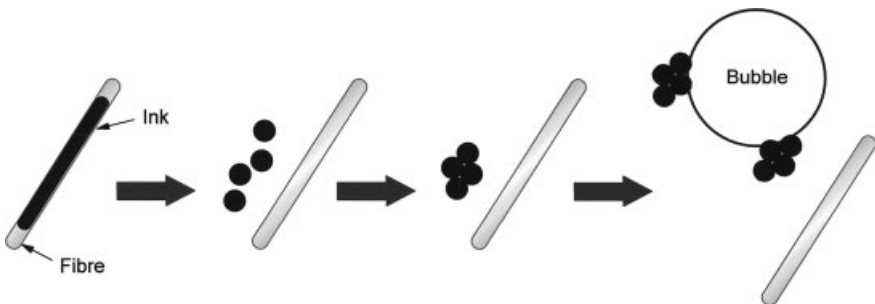
Sometimes the surfactants used for cleaning in manufacturing processes create undesirable O/W emulsions. This can be difficult to deal with since emulsification is usually an important aspect of a cleaning process. If the process or the detergent formulation cannot be adjusted to prevent the undesirable emulsion formation then a separate demulsification/separation step may be needed. In some cases these emulsions can be broken by separating out and concentrating the dispersed phase, such as by membrane ultrafiltration [454].

### 12.5.2

#### De-inking

A related application to both papermaking and detergency is in the de-inking of fibres from, for example, waste papers of various kinds. The ink may constitute 0.5–2 percent of the total mass of paper to be de-inked [767]. As the name implies, de-inking is used to remove ink particles from cellulose fibres as part of the recycling of waste papers including newsprint. This can be accomplished by washing de-inking, flotation de-inking, or a hybrid of the two processes [551,767,768]. In a washing/de-inking process the needed wetting, displacement, and dispersing actions are promoted by the addition of sodium hydroxide, sodium silicate, hydrogen peroxide and a surfactant, such as stearic acid [767]. The sodium hydroxide causes fibre swelling, saponification of ester-containing resins (varnish), and aids in dispersing the ink particles [767,768]. The sodium silicate aids both wetting of the fibres and dispersion of the ink particles. The surfactant stabilizes the dispersion of dislodged ink particles and may also aid in the wetting and displacement processes. Other surfactants, such as high HLB octylphenol ethoxylates, have also been used [193]. Washing de-inking is effective for removing small (less than 10–20  $\mu\text{m}$ ) particles from the fibres [767,779].

Flotation de-inking is effective for removing larger particles (10–300  $\mu\text{m}$ ) [767,779]. Figure 12.2 illustrates the essential processes in de-inking. The same



**Figure 12.2** Illustration of the elementary process steps in flotation de-inking. From left to right, detachment of ink from fibres, coagulation of ink particles, attachment of ink to gas bubbles, which are then floated.

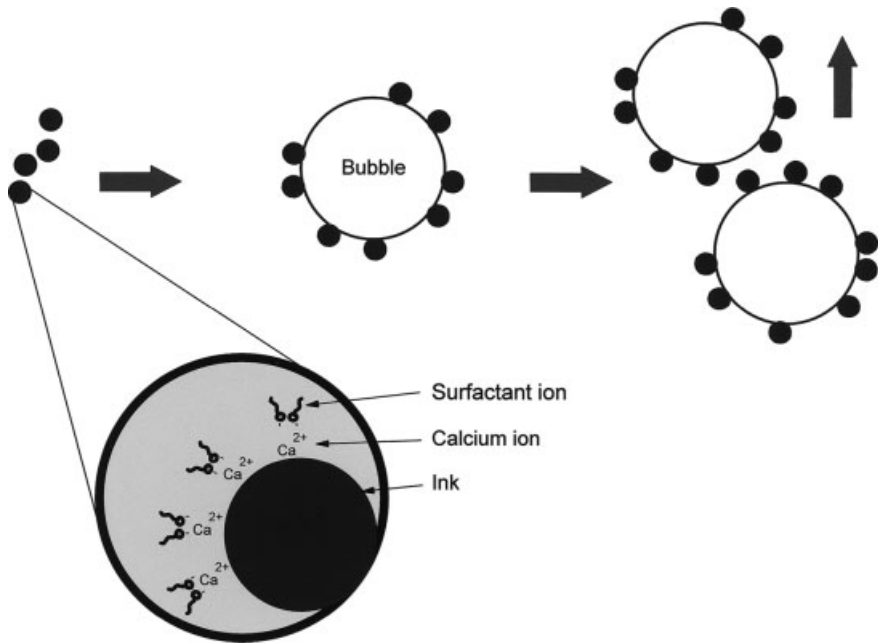
agents may be used as with washing de-inking for the promotion of wetting, ink displacement and ink dispersion [767]. In addition, as is the case in mineral flotation processes, flotation de-inking involves the use of collectors, frothers, and pH regulators, all of which are usually added during the pulping stage [779]. Examples include the additions of stearic acid, plus a calcium salt, plus another, non-polar surfactant [767]. Also, variables such as temperature, bubble size and flow rate influence the efficiency of the separation/flotation process and need to be optimized to ensure that the ink particles are floated, and not the paper fibres.

In flotation de-inking a pulping process is first applied, in which the ink is chemically detached from the fibres. Alkali helps in the separation of ink from fibre, through electrostatic repulsion, by enhancing the negative surface charges on both kinds of surfaces (the optimum pH range is generally 8–10). The surfactants used, which range from classical carboxylates (fatty acids) to non-ionics to blends, need to provide wetting and dispersion at this stage, thus helping to remove the ink particles from the fibres. Next, air is sparged into a cell and a flotation process used to separate the ink particles, much like the froth-flotation process used to separate mineral species (Section 10.3). In some cases the same surfactant can be used both to separate the ink particles from the fibres and also as the collector for the flotation of the ink particles. Sodium stearate and other  $C_{16-18}$  fatty acid soaps like sodium oleate, for example, have been used in the pulper in this way, together with the addition of calcium ions in alkaline solution (from added  $CaCl_2$  or  $CaCO_3$ ). The calcium ions cause the surfactants to precipitate onto the ink particles with their head group/calcium ion complexes adsorbed onto the particle surfaces and their hydrocarbon tails extending outward into solution [53]. Figure 12.3 provides an illustration. The ink particles then attach to air bubbles causing them to float [193].

A somewhat unusual feature of ink flotation is the influence of particle shape. Some ink particles, such as toner particles from laser ink, can appear in the de-inking pulp in plate or disk shapes. These may have a smaller probability of attaching to gas bubbles compared with spheres due to their ability to collide with the bubbles edge-on and then to rebound away without being captured [779].

The floated particles are ultimately separated from the fibres by rising to form a froth that can be skimmed off. Either the flotation surfactants, or others added during the processing, are also needed to help prevent redeposition on the fibres later [779]. A number of reviews are available on flotation de-inking [53,551,767,779] and on the kinds of flotation cells used [53,551,767].

Flotation-washing (hybrid) processes involve flotation de-inking followed by further washing processes. The latter are intended to remove fine particles of ink that were not removed by the flotation step. In this case the dispersants are usually added after the pulper but before the washing, so that any ink not initially floated will be emulsified and removed during the washing process [767].



**Figure 12.3** Illustration of adsorption of calcium-surfactant ion pairs to form collectors for ink particle to air bubble attachment and subsequent flotation.

## 12.6

### Surface Coatings including Paints and Inks

Surface coatings, including paints and inks tend to contain the same, or at least quite similar, constituents. Surface coatings and paints are used to protect and/or decorate surfaces whereas inks are used to create images and/or text. The protective function may be to guard against attack by chemicals, including water, or radiation, such as UV radiation. The decorative function may include hiding the nature of a surface, such as in IR reflecting paint. India ink is a colloidal suspension of carbon-black particles stabilized by natural gum and dispersed in water. Modern inks are more complex. Inks such as printing inks have to cover surfaces, much like other kinds of coatings, and therefore have more stringent property specifications.

The principal components in a paint are pigment, binder, and solvent. The basic steps in the manufacture of paints are [780]:

- high shear grinding of the pigment in, e.g., high-speed impeller mills or ball mills;
- low shear mixing of the binder with the water or solvent; and
- low shear mixing-in of the pigment and other additives.

The pigment provides opacity and colour (paint without pigment is termed varnish). The binder provides cohesion among pigment particles and adhesion to the intended surface. The binder needs to become solid upon drying or setting but have low viscosity during application, hence the need for solvent. In fact some lacquers and varnishes contain 80–90 percent solvent [781]. Some fatty acid (lipid) oils used in surface coatings include soybean, tall (from paper manufacture), linseed, castor and coconut oils [781]. The solvent provides the rheological properties needed in both manufacture and application of the coating. Binders have consisted of a wide range of materials from natural gums and resins to synthetic polymers.

Most coatings are applied as solutions, emulsions, or suspensions of the pigment, and are converted to solid films after application, usually by allowing the solvent to evaporate. Latex, one of the simplest of paint formulations, is simply a dispersion of high molar mass polymer particles in water. In the first stage of solvent evaporation, the rate of evaporation is essentially independent of the presence of the dissolved or dispersed pigment. As the solvent evaporates, the viscosity increases and the free volume decreases, so that the rate of evaporation becomes dependent on how rapidly solvent molecules can diffuse to the surface of the film [782].

The visual appearance of a coating is influenced by pigments, which provide the colour, and gloss, which provides texture (low surface roughness provides high gloss, and vice versa). Some pigment formulations are quite sophisticated, such as in metallic and pearlescent coatings. Metallic coatings contain transparent colours and a dispersion of aluminum flakes. Due to light scattering by the aluminum flakes, these coatings appear to have different colours when viewed from different angles. Pearlescent coatings contain mica flakes on which thin films of titanium or iron oxide have been deposited. Due to interference reflection by the mica flakes these coatings appear to have different hues when viewed and/or illuminated from different angles [782]. The pigments in a coating must be well dispersed in order for the product to perform successfully.

In aqueous systems, inorganic pigments are usually quite easy to disperse but organic pigments may require the use of a surfactant to ensure complete wetting. Electrostatic stabilization is a common means of obtaining dispersion stability, and surface charge, as determined through zeta potential measurements, may be used to optimize the inclusion of additives for best electrostatic repulsion and dispersion stability. If the pigment agglomerates, then the paint will seem to have larger pigment particles and may not achieve the desired colour quality, gloss, and texture.

In organic systems wetting and dispersion of the pigments is usually quite easy but stabilization of the dispersions normally requires steric stabilization, provided by adsorbed layers of polymer molecules. It appears that in most cases the adsorbed polymer layer has to be greater than about 10 nm for such dispersions to be sufficiently stable [782].

Both aqueous polymer-based systems (latex), made by emulsion or dispersion polymerization, and oil-modified alkyd resin-based systems are still in wide use [781]. Table 12.2 shows the composition of a typical water-based emulsion paint. There is a wide variety of coatings, ranging from broad applicability to highly specialized, including latexes, amino resins, isocyanates, epoxy resins, acrylic resins, polyester



resins, alkyd resins, alkyds, uralkyds, epoxy esters, phenolic resins, silicones, and halogenated resins [782]. Each has specific advantages in terms of cost and performance, including resistance to photodegradation, adhesion to specific kinds of surfaces, durability, and so on. Among the speciality coatings, uralkyds are used in transparent coatings (varnishes) for furniture and floors, silicones are used where low temperature flexibility is needed, and halogenated resins have low water permeability and are used for corrosion protection [782].

**Table 12.2** Composition of a typical water-based emulsion paint (from [780]).

Component	Concentration (mass %)
Propylene glycol	6.52
Aqueous polyacrylate solution (25%)	1.40
Antifoamer	0.47
Titanium dioxide (pigment)	26.53
Aqueous polyacrylate latex dispersion (46%)	50.90
Tributyl phosphate	1.71
Preservative	0.28
Antifoamer	0.47
Ammonia (25%)	0.20
1,2 Propyleneglycol	2.80
Water	8.72

Some high-performance coatings, in terms of emulsion stability, fineness of dispersion, homogeneity upon drying, and improved smoothness and abrasion resistance, can be formulated as microemulsions [226,234]. Electrocoating allows a high-performance primer coat to be applied to an electrically charged metal surface. Oppositely charged paint pigment particles then adsorb onto the metal surface where they lose their charge and become fixed.

Paints may also need to contain antifoaming and/or defoaming components since air can become incorporated into a paint during any or all of: dispersing, transportation, mixing, filling, and application steps [483,780]. Hydrophobic components, such as treated (hydrophobic) silicas or waxes, may be added to water-based paints in accordance with the principles described in Section 7.2.2, although there is a tendency to use quite specific antifoams for specific paints [780].

Surface coatings can be more sophisticated than just paints and inks. For example, carbonless copy paper involves coating two sheets of paper with different coatings. To a cover sheet is applied a thin layer of microencapsulated, colourless, dye intermediate, while to the underlying sheet is applied a coating of another colourless reagent [783]. When pressure is applied to the cover sheet, such as by pen, pencil, or typewriter, the microcapsules are ruptured, releasing the dye intermediate, which reacts with the reagent to produce a coloured image.

## 12.7

### Polymer Synthesis

Polymer colloids involve dispersions containing polymer particles having sizes greater than about 1 nm. If dispersed in aqueous solution, such a polymer dispersion is called a latex. These are usually synthetic polymer particles formed by free radical polymerization [784]. Many kinds of polymerization systems exist, involving almost all of the possible kinds of colloidal dispersion, including emulsion polymerization, hence the more general term heterophase polymerization is sometimes used. Several reviews are available [785–789]. Emulsion polymerization provides a convenient means of controlling the polymerization of monomers and is used to make, for example, synthetic rubber which is mostly a co-polymer of butadiene and styrene.

The emulsion polymerization process involves the polymerization of liquid monomers that are dispersed in an aqueous surfactant micelle-containing solution. The monomers are solubilized in the surfactant micelles. A water-soluble initiator catalyst, such as sodium persulfate, is added to the aqueous phase. The free radicals generated cause the dispersed monomers to react to produce polymer molecules within the micellar environment. The surfactant plays an additional role in stabilizing dispersion of the produced polymer particles. Thus, the surfactants used both provide micelles to house the monomers and macroradicals, and also stabilize the produced polymer particles [193,790]. Anionic surfactants, such as dodecylbenzene sulfonates, are commonly used to provide electrostatic stabilization [193]. These tend to cause production of polymer particles having diameters of about 0.1–0.3  $\mu\text{m}$ , whereas when steric stabilization is provided by, for example, graft copolymers, then diameters of about 0.1–10  $\mu\text{m}$  tend to be produced [790,791].

Microemulsion polymerization, as the name implies, involves free-radical polymerization in extremely small size, microemulsified monomer droplets of about 1–10 nm diameter [792]. The produced polymer particles tend to be small (10 nm) and have higher molar mass ( $10^6$ – $10^7$  g/mol) than can be obtained from conventional emulsion polymerization [792].

Latex applications include adhesives, fibre binders (such as in paper and textiles), coatings (such as in paints, coated papers, coated fabrics, coated flooring, and coated insulation), dipping-produced goods (such as balloons, bladders, gloves, and tubing), solid foam products (such as for cushioned furniture), and as a constituent in building materials (such as mortars and concrete) [791].

## 12.8

### Ceramics Manufacture

Controlling the stability of suspended particles, and the filtration characteristics of cast suspensions, are very important in the ceramics industry. Here the casting suspensions may comprise clays, silica, oxides, carbides or nitrides [357,793]. In slip casting, a suspension is pored into a porous mould and allowed to stand. Water dif-

fuses, due to capillary flow, from the suspension into the mould causing the suspension to gel, and then to dry, forming a filter cake on the inside surfaces of the mould that can be removed [357]. The properties of the filter cake depend on the stability, in terms of the peptization or flocculation of particles, in the original suspension [794]. For slip casting the suspension should be stable against both coagulation and sedimentation, flow easily to fill moulds, gel readily, and exhibit a slight shrinkage upon drying [357]. In other processes a suspension of silica particles, stabilized electrostatically, may be flocculated by the addition of an appropriate salt, leading to the formation of coagulated networks which eventually gel. The glazes used in ceramics are also frequently suspensions [357]. Just as is the case with paints, glaze suspensions need to be shear-thickening and thixotropic, so that the glaze will initially flow to produce a smooth coating, then thicken to prevent running.

Another process, sol-gel processing, allows powders with very small particle sizes to be made at low temperature [794,795]. A suspension of very fine particles is prepared and then gelled. The gel can be dried using supercritical extraction to produce a low-density aerogel, a solid that retains most of the original open structure. Alternatively, the gel can be evaporated to dryness to produce a high-density xerogel that is still porous. Either approach can produce solid materials that have very uniform properties. As is the case with conventional ceramics, sol-gel techniques can be applied to slip casting or to layer-wise application by spinning, dipping, or spraying. In the latter case, controlled drying can produce a thin film on a glass, plastic, ceramic, metal, or other substrate.

## 12.9

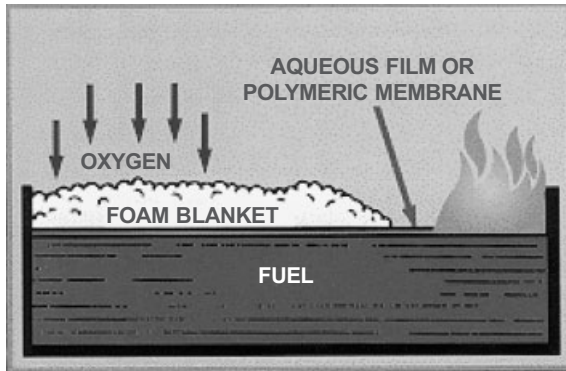
### Fire-Fighting Foams

Foams can play a very important role in fire fighting, and have been used for this purpose for at least a hundred years. Some of the history of this development, and a description of the early formulations of suitable foaming agents, are given by Bikerman *et al.* [43]. Fire-fighting foams may be found in many industrial operations that involve the transportation, processing, or handling of flammable petroleum liquids, including refineries, airports, and off-shore production platforms [43].

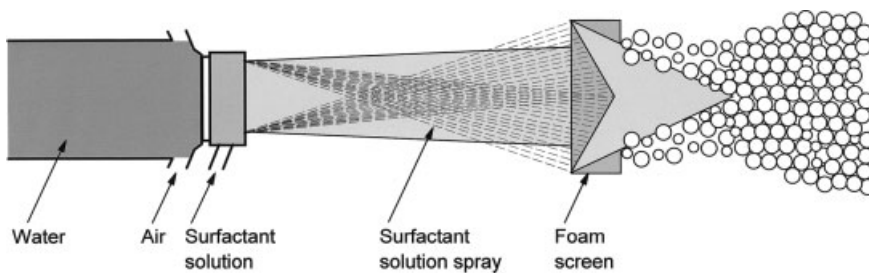
Fire-fighting foams greatly reduce the density of water and allow it to spread easily over the fuel. These foams kill fires through a combination of the following [44,796–799]:

- blanketing the burning fuel surface and smothering the fire;
- suppressing and preventing air from mixing with flammable vapours;
- separating flames from the fuel's surface; and
- cooling the fuel and its surface by the action of the water in the foam.

Some of these are illustrated in Figure 12.4 [800]. The foam is created by mechanically mixing air (typically 75–97%) with a concentrated solution of surfactant in water, as shown in Figure 12.5 [801].



**Figure 12.4** Illustration of a fire fighting foam. From reference [800]. Copyright 2005, Reliable Fire Equipment Company.



**Figure 12.5** Illustration of a fire hose with a venturi-principle foam nozzle. Adapted from Figueredo and Sabadini [801].

The surfactants used need to boost foam formation and stability, promote wetting or spreading of the foam over the fuel, and must not emulsify the hydrocarbon fuel [797,802]. These foams are often formulated to contain fluorocarbon surfactants, which are less soluble than hydrocarbon surfactants in gasoline [629], and are sometimes blended with hydrocarbon surfactants and/or polymers. Foams that can be effective on hydrocarbon fuel fires are typically characterized as protein (P, hydrolyzed protein surfactants), fluoroprotein (FP, hydrolyzed protein and perfluorinated surfactants used, for example, on storage tanks), film-forming fluoroprotein (FFFP, used, for example, in sprinkler systems), aqueous film-forming (AFFF, blend of perfluorinated surfactants used, for example, on oil platform helidecks), and alcohol-resisting aqueous film forming (AFFF-AR, used, for example, for alcohol or polar solvent fires) [796]. Each kind has its own advantages and disadvantages. For example, the protein foams are inexpensive and produce thick foams but do not spread well over burning fuel, the fluoroprotein foams resist fuel pick-up, the AFFF spreads over burning fuel faster but has faster drainage times and poorer heat resistance, and the FFFP foams are somewhat of a compromise between the AFFF and P types [799]. Usually blends of surfactant are used, such as the alcohol-resistant variations

of AFFF or FFFP, which contain neutral polymers that are insoluble in polar solvents [193,799].

Practical fire-fighting foam formulations may contain numerous other additives to control freezing, viscosity, bacterial degradation, oxidation, corrosion, and so on [43,44,797]. They may also contain drag reducers, such as poly(ethylene) oxide, to improve spreading of the foam over the fuel [801]. The most commonly used foams for fire fighting contain 75–97% air; these are known as “low expansion” foams. For a fire-fighting foam to be effective it must possess the following attributes [802]. It should:

- be resistant to large electrolyte concentrations (i.e., sea water);
- have insignificant toxicity and biodegradability;
- have long-term storage stability;
- be undamaged by inadvertent freezing–thawing cycles; and
- be freeze-resistant for cold climates.

Foam-selection criteria include classical properties like static half-lives, but also properties like expansion and fire-extinguishing performance. Corrie [797] and Fitch [799] describe a range of laboratory evaluation methods for foam stability and fire-extinguishing effectiveness. Fire-fighting foams may be found in any of the many industrial operations involving the transportation, processing, or handling of flammable petroleum liquids, including refineries and off-shore production platforms.

## 13

## Food Product and Agricultural Applications

## 13.1

## Introduction to Food Colloids

Table 13.1 lists some of the many kinds of food colloids. These products have some special requirements in that they have to have specific texture, taste, and nutritional requirements. The food industry's emulsion, foam and suspension products can be very complex since foods contain such a wide array of components, including proteins, fats, emulsifiers, hydrocolloids and particles. There are also some special requirements arising from the need for food products to meet certain standards of consumer safety and consumer acceptance. Due to their intended use, food colloids need to be non-toxic, non-carcinogenic, and non-allergenic [803]. They also need to be stable for periods of months to years, including stability against such processes as aggregation, creaming, coalescence, and gelation.

**Table 13.1** Some food colloids: emulsions, foams, and suspensions\*.

Emulsions (O/W)	Milk, ice cream, creams, coffee creamers, cream liqueurs, soft drink syrups, mayonnaise, sauces (e.g., hollandaise, béarnaise), sausages, whippable toppings, some salad dressings, some fruit drinks.
Emulsions (W/O)	Butter, margarine, spreads, processed cheese, some salad dressings.
Foams	Ice cream, whipped cream and toppings, béarnaise, souffles, mousses, aerated icing.
Products made from foams	Bread, cakes, meringue, marshmallow.
Suspensions	Ice cream, vegetable shortening, chocolate drinks, water ice (a semi-frozen drink).

\* Some food colloids are multiple dispersions. For example, béarnaise sauce is an emulsion and a foam.

The widespread importance and ubiquitous nature of food products, together with scientific interest in their formation, stability and properties, have precipitated a substantial body of published literature on the subject. There are many books on food colloids [33,36,492,804–811] and several monograph series, including *Food*

*Science and Technology* (Dekker), *Developments in Food Science* (Elsevier), and *Food Science Texts Series* (Kluwer). There are also many published reviews [803,812–815].

The oils in food colloids are usually triglycerides, and may be of animal or vegetable origin. These may exist in liquid and/or crystalline states at room temperature. The possible existence of the crystal form influences homogenization processes, coalescence, and texture [78,428] so formulators need to know the melting profiles of the oils being considered for use. Although some assistance is provided by creating small droplet/particle sizes and by increasing the continuous phase viscosity, most of the stability arises from the structure and properties of the interfacial layers surrounding the droplets, bubbles, or particles.

The structure of the interfacial layers in food colloids can be quite complex as these are usually comprised of mixtures of a variety of surfactants and all are probably at least partly adsorbed at interfaces which even individually, can form complex adsorption layers. The layers can be viscoelastic. Phospholipids form multi-lamellar structures at the interface and proteins, such as casein, can adsorb in a variety of conformations [78]. Lecithins not only adsorb also at interfaces, but can affect the conformations of adsorbed casein. The situation in food emulsions can be complicated further by the additional presence of solid particles. For example, the fat droplets in homogenized milk are surrounded by a membrane that contains phospholipid, protein and semi-solid casein micelles [78,816]. Similarly, the oil droplets in mayonnaise are partly coated with granular particles formed from the phospho and lipo-protein components of egg yolk [78]. Finally, the phospholipids can also interact with proteins and lecithins to form independent vesicles [78], thus creating an additional dispersed phase.

The nature of the colloidal dispersion can have important influences on other food properties. For example, a 50/50 % emulsion of oil (fat) and water has a very different thermal properties in O/W versus W/O form. The O/W emulsion would be expected to have the greater thermal conductivity, water being the external phase and, other factors being equal, should freeze at a faster rate [811]. O/W food emulsions tend to be quite fluid, whereas W/O food emulsions tend to be more viscous, sometimes solid-like.

## 13.2

### Stabilizing Agents

Many food colloids are stabilized from proteins from milk or eggs [817]. Milk and cream, for example, are stabilized by milk proteins, such as casein micelles, which form a membrane around the oil (fat) droplets [817]. Mayonnaise, hollandaise, and béarnaise, for example, are O/W emulsions mainly stabilized by egg-yolk protein, which is a mixture of lipids (including lecithin), proteins, and lipoproteins [811,817]. The protein-covered oil (fat) droplets are stabilized by a combination of electrostatic and steric stabilization [817]. Alcohols may also be added, such as glycerol, propylene glycol, sorbitol, or sucrose; sometimes these are modified by esterification or by

reacting them with ethylene oxide [803]. There are several reviews of food emulsifiers [803,818–820].

Most of the surfactants used to stabilize food emulsions and foams fall into two categories [293,803,814,820]:

- Low molar mass species, such as lipids, phospholipids (lecithin), mono- and diglycerides<sup>1)</sup>, sorbitan monostearate, polyoxyethylenesorbitan monostearate.
- High molar mass species, such as proteins and gums.

The low molar mass species usually have long-chain fatty acid groups which provide the hydrophobic groups. The polar groups may be, for example, glycerol (in mono and diglycerides) and substituted phosphoglyceryl species (in phospholipids) [78]. These surfactants are commonly distinguished based on their HLB values (see Section 7.1.1). They adsorb and orient with hydro and lipophilic portions of the molecule oriented into the corresponding phase. These tend to be used in the preparation of, for example, W/O emulsions. Monoglycerides form lamellar phases: bilayers separated by aqueous layers. These lipid bilayers can improve the texture of fat-free foods such as spreads, dressings, and baked products; and when sufficiently cooled they can gel [818].

The high molar mass species reside mostly in the aqueous phase with a number of peptide groups residing in the oil/water interface [293]. Although these latter surfactants are less effective at reducing interfacial tension, they can form a viscoelastic membrane-like film around oil droplets or air bubbles. These tend to be used in the preparation of, for example, O/W emulsions. These trends are by no means exclusive, mixtures are the norm and competitive adsorption is prevalent. Caseinate, one of the most commonly used surfactants in the food industry, is itself a mixture of interacting proteins of varying surface activity [814].

There are also several water-soluble mixtures of polysaccharides, including those derived from seaweeds and marine animals, such as gum arabic, agar, algin, carrageenan, and chitin. These are hydrophilic. Their suspensions in water can be quite viscous and can readily form gels, and they can form viscous interfacial films around dispersed droplets and bubbles [821]. They are used to stabilize suspensions, foams, and emulsions and are used in many different foods and medicines including, for example, ice cream [428,430]. *See also* Ref. [822].

For food emulsions one needs both stability against coalescence and also stability against creaming. Developing a high degree of electrostatic and steric stabilization to prevent coalescence also contributes hindrances to creaming. In addition, the formulation of “thickening” polymers into food emulsions raises the viscosity and proportionally decreases the creaming rate [94] (see also Section 2.4.1).

1) Mono- and diglycerides are derived from partial hydrolysis of animal or vegetable fats.



**13.3****Preparation**

Food emulsions are usually made using rotating devices that range from simple paddle-stirrers to scraped-surface mixers to colloid mills, if very small droplet sizes are not required, such as for mayonnaise or salad cream [78,812]. When very small droplet sizes are needed, such as for cream liqueurs, then a coarse emulsion is usually passed through a high-pressure homogenizer [78,428], which can produce droplets smaller than 2  $\mu\text{m}$  in diameter. High shear rates tend to be needed for emulsification into small droplets, while high flow rates tend to be needed for good heat transfer or blending [429].

Food foams are usually made by bubbling, whipping, or shaking a protein-containing solution. Several measures of foaming capacity of proteins and other stabilizing agents exist, such as overrun, which quantifies the amount of foam produced, defined as:

$$\text{Overrun} = 100 (V_F - V_L) / V_L \quad (13.1)$$

where  $V_F$  is the foam volume and  $V_L$  is the volume of initial liquid [293]. Overrun is related to the amount of interfacial area stabilized by the protein. Of course, it is also possible to relate the volume of foam produced to the volume of air used to generate the foam [823].

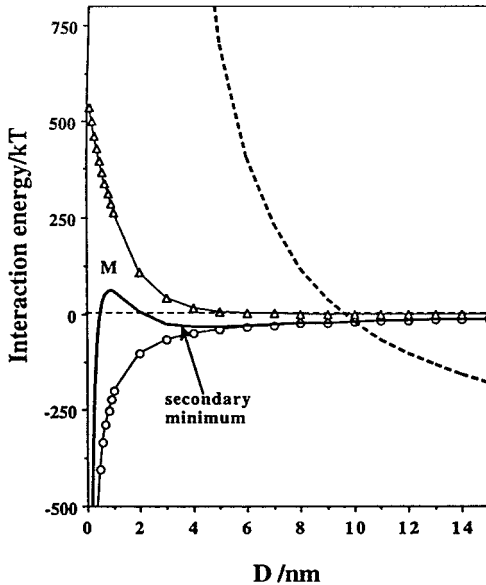
Food suspensions are made by any of the suspension preparation techniques described elsewhere in this book (see, for example, Section 7.1.3). Related to food suspensions are a variety of microencapsulated ingredients used in foods, which are usually in the form of a suspension at some stage in their production. The encapsulated ingredients may be gas, liquid, or solid, and the encapsulating shell is usually a polymer coating, such as one of the food hydrocolloids (e.g., gum acacia, gelatin, etc.) [783]. Some of the kinds of ingredients that are encapsulated include flavour oils, flavour modifiers (acids), colours, sweeteners, vitamins and minerals [783]. The principal methods of microencapsulation for food ingredients, including spray drying, spray cooling/chilling, air suspension coating, extrusion, and coacervation, are reviewed by Dziezak [783]. For other types of microencapsulation see Sections 14.2, 14.3, and 14.4.

**13.4****Stability**

The principles of colloid stability, including DLVO theory, disjoining pressure, the Marangoni effect, surface viscosity, and steric stabilization, can be usefully applied to many food systems [291,293]. Walstra [291] provides some examples of DLVO calculations, steric stabilization and bridging flocculation for food colloid systems.

The applicability of DLVO theory is restricted partly because the primary potential energy minima are somewhat shallow. Another factor is the tendency of adsorbed

proteins to extend outward from surfaces so far that the adsorbed layer thickness can reach the order of magnitude of the Debye length, or more [816]. Thus there can be significant protein molecule overlap before significant electrostatic potential can develop between the dispersed species [78,816]. Figure 13.1 shows an example. The limited applicability of DLVO theory to food colloids is consistent with the fact that increasing ionic strength in such systems frequently does not lead to instability. It is also consistent with the fact that many food colloids do not follow the Smoluchowski kinetics for perikinetic aggregation that would be expected for dispersed species in the presence of an energy barrier [78].



**Figure 13.1** Calculated energy profiles of attractive van der Waals (○) and repulsive electrostatic (△) interactions between two oil droplets coated with a  $\beta$ -casein adsorbed layer. The diameter of each droplet was assumed to be  $4\ \mu\text{m}$ . The surface potential  $\psi_0$  for the  $\beta$ -casein layer was assumed to be  $-20\ \text{mV}$ . The thick solid line represents the sum of attractive van der Waals and repulsive electrostatic interactions. The thick broken line represents the net free energy profile as a function of distance when steric repulsion is also taken into account. From Damodaran [293]. Copyright 1997, Dekker.

Steric stabilization appears to be the dominant stabilizing force in most food colloids [78,824]. Casein-coated emulsion droplets provide an example. The presence of protein in an adsorption layer can also contribute viscoelasticity and provide a barrier to coalescence.

Flocculation in O/W systems provides a means to control stability and texture, and can be produced through several mechanisms [817]:

- reducing surface charge through pH adjustment towards the protein isoelectric point;
- compressing electric double layers by adding electrolyte;
- reducing the continuous phase's solvating ability for adsorbed protein by adding alcohol;
- bridging flocculation caused by the addition of polymers such as ionic polysaccharides (of opposite charge to the proteins); or
- depletion flocculation caused by the addition of non-adsorbing polymers such as neutral polysaccharides.

### 13.5

#### Protein-stabilized Emulsions

Some food O/W emulsions, including milk, cream, ice cream, and coffee whiteners and toppings, are stabilized by proteins such as casein that form a coating around the fat globules. These products also need to have some of the fat (oil) be partly crystalline to link the droplets in a network structure and to prevent complete coalescence of the oil droplets, especially under shear [78,825].

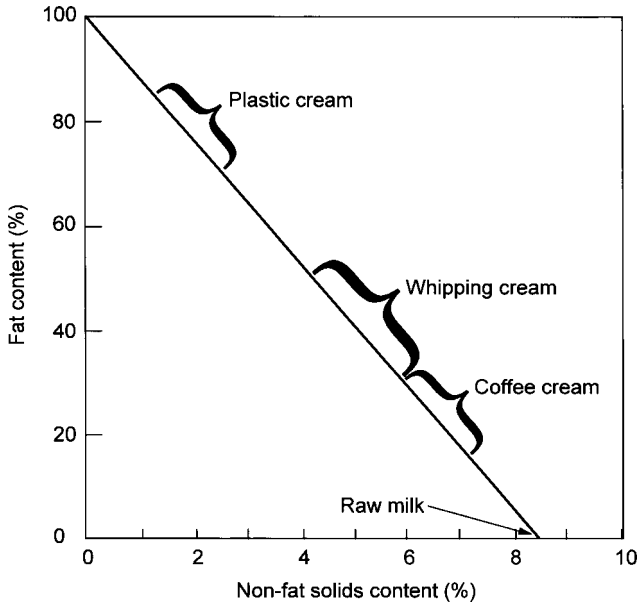
Milk contains about 40 g/L of fat and 32 g/L of protein. The milk fat occurs in droplets stabilized by layers of phospholipid and protein [78]. Of the protein about 25 g/L is casein and 7 g/L is serum proteins (mostly lactoglobulins). The caseins form "casein micelles" which involve both casein and calcium phosphate, may contain 500–10 000 casein protein molecules, and are of the order of 200 nm in diameter [78,816,824]. The casein micelles are quite complex. There are four types of casein molecules of which most ( $\alpha_{s1}$ ,  $\alpha_{s2}$ ,  $\beta$ -caseins) complex with calcium phosphate and reside in the interior of the micelles, while one type, the  $\kappa$ -casein, mostly forms a stabilizing surface layer [816,824]. Homogenization involves breaking the stabilizing films surrounding both fat droplets and casein micelles, allowing interaction between them [824]. The newly created, smaller, fat droplets become stabilized by casein micelles and fragments of casein micelles [824].

Cream is the fat-rich portion of milk that is separated by skimming and contains at least about 18–20% fat (still in the form of an O/W emulsion). As the fat content increases from skimmed milk through thick creams, the solids-not-fat content decreases as illustrated in Figure 13.2 [826]. The viscosities of milk and cream depend on the concentrations of both fat and solids-not-fat as shown in the following empirical equation [215]:

$$\eta_m = A_1 + A_2 F_m + A_3 S_n + A_4 F_m^2 \quad (13.2)$$

where  $\eta_m$  is the viscosity of the milk or cream,  $F_m$  and  $S_n$  are the concentrations of fat and solids-not-fat respectively, and  $A_1$ ,  $A_2$ ,  $A_3$ , and  $A_4$  are empirical constants.

The complex structure of milk can be radically altered during processing. For example, changing the pH causes disintegration or rearrangement of the casein



**Figure 13.2** The relationship between fat content and non-fat solids content for milk or creams of a given composition (solid line). The brackets show the approximate fat to non-fat ranges for different creams. Adapted from data in Sogo *et al.* [826].

micelles [824]. Rennet attacks the  $\kappa$ -casein of casein micelles and fragments, and causes de-stabilization of the fat globules and consequent aggregation [824]. Cheese is produced by proteolysis with a specific enzyme followed by a pH decrease, cottage cheese is produced by a pH decrease followed by proteolysis, and yogurt is produced by heat followed by a pH decrease. Each of these processes cause a different series of chemical and or physical changes to the stability of the casein micelles. Structural changes induced by processing can also have undesirable effects, reducing the stability of intended products.

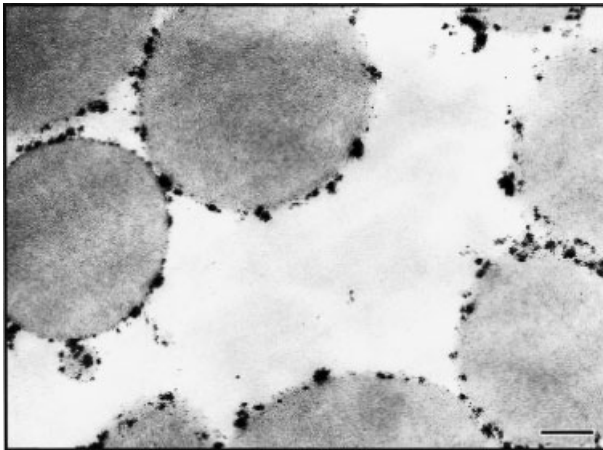
Part of the process to make cheese involves the flocculation of an electrostatically stabilized colloidal O/W emulsion of oil droplets coated with milk casein. The flocculation is caused by the addition of a salt, leading to the formation of networks which eventually gel. The other part of the process involves reaction with an enzyme (such as rennet), an acid (such as lactic acid), and possibly heat, pressure and micro-organisms, to help with the ripening [811]. The final aggregates (curd) trap much of the fat and some of the water and lactose. The remaining liquid is the whey, much of which readily separates out from the curd. Adding heat to the curd ( $\sim 38^\circ\text{C}$ ) helps to further separate out the whey and convert the curd from a suspension to an elastic solid. There are about 20 different basic kinds of cheese, with nearly 1000 types and regional names. Potter provides some classification [811].

Having proteins present reduces the interfacial tension from about 27 mN/m for a pure oil/water system, to about 14 mN/m [827]. This may provide a sufficiently

low interfacial tension for emulsification or, if not, it can be easily reduced to 3–10 with the addition of an additional emulsifying surfactant such as citric acid esters of monoglycerides [827]. The surface visco-elastic properties of proteins can significantly increase emulsion stability by reducing the droplet coalescence rate [828]. The adsorbed proteins can also provide emulsion stabilization by steric stabilization, particularly at very high levels of surface adsorption, in which case the adsorption layer can include not just protein molecules but structured protein globules (aggregates). The amount of protein adsorbed at an interface is called surface load, or protein load, and is usually expressed in units of  $\text{mg protein per m}^2$  of surface area. A monolayer of unfolded polypeptide chains produces a protein load of about  $1 \text{ mg}\cdot\text{m}^{-2}$ , whereas protein loads involving aggregates or multilayers can reach tens of  $\text{mg}\cdot\text{m}^{-2}$  [827].

In products like ice cream (see next section), proteins, additional emulsifier(s) (such as monoglycerides), and gum hydrocolloids may all take part in forming a stabilizing film around the oil droplets. In this case emulsion properties can be adjusted by changing the relative concentrations of the various stabilizing components. Being foams as well, ice cream and whipped cream also contain dispersed air bubbles, which are stabilized by fat globules or crystals [825,827]. Monoglycerides and other surface-active lipids can also enhance the stabilization of the foam.

Non-dairy creams (cream alternatives) are O/W emulsions stabilized by milk proteins. A relatively thick adsorption layer provides stability, mostly by steric stabilization and partly by electrostatic stabilization [829]. Figure 13.3 shows an example of a soybean-oil and milk-protein emulsion stabilized by fat globules and protein membranes. Stabilizers, such as hydrocolloid polysaccharides, are added to increase the continuous phase viscosity and reduce the extent of creaming. They must be stable enough to have a useful shelf-life but de-stabilize in a specific way when they are



**Figure 13.3** Transmission electron microscope image of a soybean oil and milk protein emulsion showing the fat globules and protein membranes. The scale bar = 200 nm. From reference [880]. Copyright 2003, Agriculture and Agri-Food Canada.

whipped [323,829]. A kind of oil droplet aggregation termed “clustering” is used to increase viscosity and partially gel the cream, providing both spoonability and an appearance of thickness. Clustering is achieved when emulsion droplets are subdivided to the point at which the total interfacial area in the emulsion is greater than the surface-covering capability of the adsorbing proteins. This leads to proteins bridging between pairs of droplets (bridging flocculation) [323,829]. When creams are whipped to make whipped cream foam, the stabilized oil droplets have to overcome some of their stability, based only on the application of mechanical shear, and form a network of oil droplets around the air bubbles, providing the necessary product stability and texture [323,829]. This involves rupturing the original interfacial film between oil droplets in the original emulsion and incorporation of fat crystals into the new interfacial films in the foam. Thus, the need for some of the fat to be in the form of crystals is what requires the cream to be cooled before whipping. Monoglycerides are also used to enhance the stability of the air bubbles, partly by displacing some of the adsorbed proteins from the interface and enhancing the fat droplet aggregation [818].

Casein or egg-yolk proteins are used as emulsifiers in a number of food products, such as O/W food emulsions (Table 13.1) [78,824]. A key difference here is that in caseinate-stabilized oil emulsions, the casein forms essentially monolayers and there are no casein micelles nor any calcium phosphate. Such emulsions are thought to be stabilized more by electrostatic repulsive forces and less by steric stabilization, in contrast to the situation in homogenized milk products [824].

Sauce béarnaise, for example, is an O/W emulsion that is mainly stabilized by egg-yolk protein in an aqueous phase of low pH. Perram *et al.* [830] describe how this system is primarily stabilized by electrostatic repulsive forces, and show how DLVO theory can be used to describe the effects of pH, surface charge, ionic strength, and temperature, on the stability of this emulsion.

### 13.5.1

#### Ice Cream

Ice cream is a partially frozen foam that is also an emulsion and a suspension, containing many components including proteins, fat, water, and air. A typical ice cream mix might contain milk fat (10–16%), milk solids-not-fat<sup>2)</sup> (9–12%), sugars (9–12%), corn syrup solids (4–6%), stabilizers and emulsifiers (0–0.5%), and water [430,811,815]. When prepared, ice cream may have an overrun (Section 13.3) of 70–100% (that is, it will contain 40–50 volume percent air) [811], see Table 13.2. Due to the partial freezing, ice cream also contains dispersed ice particles. At –11 °C ice cream has a viscosity of about 10<sup>9</sup> mPa·s [215].

- 2) Milk solids-not-fat (msnf) comprise lactose, casein micelles, whey proteins, minerals, vitamins, acids, and enzymes derived from milk [430,811,815].

**Table 13.2** Illustration of the composition of ice cream.

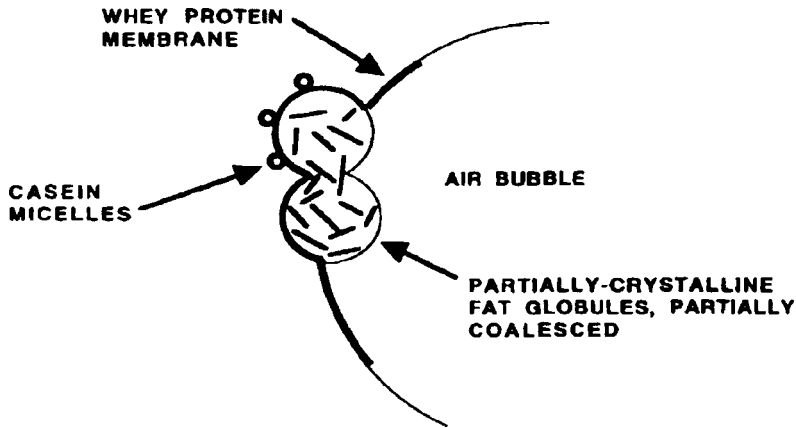
Ingredient	Concentration (volume %)
Air	50
Ice	25
Matrix (sugars, most of the proteins, stabilizers)	20
Fat	5

Ref.: [831]

The first step in formulating ice cream is to create an emulsion, essentially homogenized milk, using a homogenizer. This forces the hot ingredients (milk fats, milk solids-not-fat, sweeteners, corn-syrup solids, stabilizers/emulsifiers, other dry solids) through small orifices under moderate pressure (about 15–19 MPa). Fat-droplet diameters decrease to 0.4–2.0  $\mu\text{m}$ , allowing a large surface area for adsorption of proteins (which in turn stabilize the emulsion against coalescence), and the uniformity of droplet sizes results in greater stability of fat droplets during ageing, a better whipping ability and a smoother, more uniform final product. Emulsifiers are used to improve the whipping quality of the formulation, to improve moulding, body, texture, and melt resistance [259,815]. The adsorption of emulsifiers (such as casein, egg yolk, monoglycerides, sorbitan esters, diglycerides) decreases the interfacial tension between fat globules and the surrounding liquid phase, or serum, even more than does just mere adsorption of proteins (to about 2.2 mN/m). The surface of an oil (fat) droplet may thus contain casein micelles, whey protein, mono and diglycerides, polysorbate, and lecithin [831,832]. Ice cream stabilizers (such as guar, carboxymethyl cellulose, xanthan, etc.) are used to produce smoothness in body and texture, to reduce ice and lactose crystal growth during storage, to provide product uniformity and to resist melting [833,834]. Freezing is usually done at a temperature of about  $-7^{\circ}\text{C}$ , with about 75% of the water being turned to ice [215].

The second stage in ice cream production is foaming and emulsion destabilization. This is analogous to the foaming step in whipped cream [814,835]. Air is incorporated by whipping or by air injection. Egg white acts as a foaming agent. The added shear causes controlled partial coalescence (enhanced by the adsorbed emulsifier), causing air bubbles ( $\sim 50\text{--}150\ \mu\text{m}$ ) to be trapped in clumped fat globules ( $\sim 0.5\text{--}0.8\ \mu\text{m}$  droplets), and also ice crystal formation ( $\sim 25\text{--}50\ \mu\text{m}$ ). The lamellae between the air bubbles tend to be 30–300  $\mu\text{m}$  thick [215] which is much thicker than the lamellae in conventional aqueous foams.

When whipping and freezing occur simultaneously, good fat de-stabilization is achieved and a complex internal structure is achieved that has fat globules both adsorbed onto air bubbles and aggregated to each other, in addition to the presence of casein and whey proteins, plus the ice crystals [430,813,831,833,834,836]. Figure 13.4 provides a partial illustration. Goff [430] illustrates the structure in a series of cryogenic SEM photomicrographs. Other illustrations are given by Potter [811] and Campbell and Pelan [831]. DLVO theory (Section 5.2) has been applied to describe the stability of this complex kind of dispersion [831]. The rheological properties of ice cream have been described by Sherman [215].



**Figure 13.4** Illustration of the adsorption of partially-coalesced fat globules and their associated protein membranes to an air bubble interface. From Goff [815]. Copyright 1997, Elsevier.

### 13.5.2

#### Cream Liqueurs

Cream liqueurs are emulsions that have a cream-like appearance and need to remain stable for years despite having a high alcohol content (often 17 volume %, sometimes as high as about 25 volume %) [814]. The difficulties contributed by the alcohol content include making the aqueous phase a poorer solvent for proteins [814]. As is the case in making ice cream, the homogenization process ruptures the protective membrane surrounding oil (milk fat) droplets leaving droplets that are coated with casein protein, except that in this case smaller droplets ( $<0.8 \mu\text{m}$  diameter) are produced. The total solids content is of the order of 40 mass %. Some of the other ingredients include: sodium citrate, which is used to sequester calcium ions (from the milk), and sugars, which are added for sweetness and also to increase the perception of alcoholic strength [814].

**Example.** Cream liqueurs are an example of a food emulsion for which good stability over a period of several years is required. Thus the processes of creaming, flocculation, and coalescence must all be controlled in the formulation. The product must have a cream-like appearance and a relatively high alcohol content. A possible composition might be:

water	$\approx 50 \text{ wt } \%$
sugar	$\approx 18 \text{ wt } \%$
alcohol	$\approx 14 \text{ wt } \%$
fat	$\approx 14 \text{ wt } \%$
caseinate	$\approx 1 \text{ wt } \%$
modified starches	$< 1 \text{ wt } \%$
citrate	$< 1 \text{ wt } \%$



One way to prevent creaming is to make the emulsion drops very small. Thus the milk fat might be homogenized to yield droplets smaller than 0.8  $\mu\text{m}$  diameter (this is a finer emulsion than in homogenized milk). A second way to prevent creaming might be to add some modified starch to the water/alcohol phase to increase the viscosity and provide a yield stress. The major emulsifier stabilizing the droplet dispersion is caseinate which forms a protective coating around the drops. The caseinate protection is sensitive to the presence of calcium ions (from the milk) so a little citrate is added to sequester the calcium. The sugar is added for sweetness and also to enhance the perception of alcoholic strength. Total solids content is about 40 %.

### 13.6

#### Non-protein-stabilized Emulsions

Some products, like butter and margarine are stabilized by fat crystals. Salad dressings and beverage emulsions are stabilized by other emulsifiers. The stability of non-protein stabilized food emulsions, involving lower molar mass type molecules, tend to be better described by the DLVO theory than are protein-stabilized emulsions. An example of an O/W emulsifier whose emulsions are fairly well described by DLVO theory is sodium stearoyl lactylate [812].

Butter is an emulsion of water, air, fat crystals, and fat globules in oil. The milk fat content is typically between 80 and 90%. It results from churning, in which phase inversion from O/W to W/O takes place. Air is whipped into the cream forming a foam that is stabilized by milk proteins. The mechanical shear also causes some of the semi-solid fat globules to lose their stabilizing membrane, deform and rupture, releasing liquid fat, which promotes aggregation of the remaining fat globules plus fat crystals [811,825,837]. This continues until the foam is broken and butter granules form. Water is added as needed and the granules are churned to distribute the water, producing a smooth texture. Chilling causes additional fat crystallization and increases the overall viscosity, producing the desired consistency.

Margarine (W/O) is similar to butter except that the fat is not (or at least mostly not) milk fat [837]. Synonyms from older terminology include oleo oil and oleomargarine [838]. The most commonly used oils in margarine include soybean, cottonseed, corn, safflower, and canola. A stable O/W emulsion similar to cream is formulated and churned, including inversion to W/O, in much the same way as is done to make butter. Typically consisting of 80–90% vegetable and/or animal fat, the hot homogenized mixture of fat crystals, liquid oil and water does not have to be a stable emulsion since the emulsion is quickly set by rapid chilling. Originally the “water” was milk, but in modern times this has largely been replaced by an aqueous phase containing milk proteins [838]. The latter, together with lecithins, and mono and diglycerides provide stability and texture. The added emulsifiers not only influence stability but also reduce interfacial tension and influence drop-size distribution, hence influencing the creaminess of the product [839]. They can also modify the extent and type of fat crystallization [837]. Mixed gels have also been used [837].

$\beta$ -carotene is often added to produce a yellow colour and provide vitamin A. By varying the amounts of components such as vegetable oils, animal fats and milk fat, a wide range of variations have come into use. Some examples of these “spreadable fats” include butter, margarine, low-fat spread, vegetable-fat spread, butter-fat spread, low-calorie spread, yellow-fat spread, water-continuous spread, and so on [837]. The reduced-fat and low-fat spreads tend to have fat contents of 10–79 %. Flack [837] provides an illustration of a process-plant layout for the manufacture of spreadable fats.

Shortening has some similarities to margarine, but is a suspension of small crystals in oil, rather than an emulsion. The term shortening was originally used to refer to the lard used to make bread and pies, but now more commonly refers to any commercial fat or oil. The term shortening refers to its ability to tenderize baked foods by preventing the cohesion of wheat gluten strands during mixing. In this way the gluten strands are essentially “shortened” compared with their state if shortening is not employed [838]. A shortening suspension is plastic, that is, it is rheologically characterized as being pseudoplastic with a yield stress (see Section 6.3.3). Shortenings are usually made from partially hydrogenated vegetable oil stocks, possibly mixed with animal fat. Solid (at room temperature) fats are added (15–30%) to create a shortening suspension with the desired yield stress [428,838]. Usually the various ingredients are mixed together as a liquid (at high temperature) then mechanical shear and cooling are applied, in a device like a votator scraped-surface heat exchanger, to cause fast nucleation and crystallization. Pourable shortenings do not have the yield stress of plastic shortenings and may be suspensions, emulsions, or clear liquids. Pourable shortenings are easy to dispense and are used, for example, in continuous baking-process machines.

Mayonnaise is an example of an O/W emulsion (vegetable oil in diluted vinegar) in which the emulsifier is egg yolk (a source of phospholipids) [811,839]. Here water is the continuous phase even though the volume fraction of oil is higher. Mayonnaise and O/W-type salad dressings tend to be stabilized by ionic surfactants which provide electrostatic stabilization as described by DLVO theory, or by non-ionic surfactants which provide a viscoelastic surface coating. In some cases, lipid liquid crystal layers surround and stabilize the oil droplets, such as the stabilization of O/W droplets by egg-yolk lecithins in salad dressing [827]. Such liquid-crystal layers are thought to reduce coalescence by reducing the van der Waals attraction between droplets, and by having a viscosity of about 100 mPa·s (about 100 times that of water). In addition to forming mono or multi-layers around oil droplets, phospholipids can interact with each other to form lamellar phases or vesicles [78].

Peanut butter is a suspension of ground peanut in roasted peanut oil and hydrogenated vegetable oil, containing salt and stabilizers. The suspension is milled to produce a spreadable and consumer-acceptable consistency. Although peanut butter can be made from roasted peanuts alone, over time the product will spoil and, in addition, the oil will separate out and form a layer on the top. The former is dealt with by adding salt. The latter is dealt with by adding stabilizers. These are usually mono and diglycerides [820] but many others are available (e.g., [840,841]).

## 13.6.1

**Carbonated Soft Drinks**

Carbonated soft drinks are frequently prepared by diluting and carbonating “bot- tler’s” soft drink syrups, which are O/W emulsions of flavouring oils (about 10 vol- ume %) in aqueous solutions of sugars, colouring and preservatives [814]. Some fla- vours, such as citrus oils, are not water soluble or miscible so they are made disper- sible by formulation into an O/W emulsion [842]. These emulsions must be stable enough to survive shipping and storage prior to bottling, plus the dilution and stor- age prior to sale and use. In this case the emulsifiers tend to be of the low molar mass type, such as polysaccharides (not proteins) [814]. Fruit juices tend to be turbid due to suspended fragments of cell walls, which has led to a consumer expectation that all fruit-type drinks will be turbid. As a result turbidity has become a product requirement. This may be met by introducing other suspended particles, or even emulsion droplets.

## 13.7

**Foam Food Products**

As already mentioned, some food emulsions, such as ice cream and sauce béarnaise, are also foams. Food foams, like food emulsions, can be stabilized by the natural surfactants present, such as proteins, like casein or egg white. The surface visco- elastic properties of proteins can significantly increase foam stability by reducing the liquid drainage rates in the foam lamellae [828]. For example, bovine serum albumin is a good foaming agent that also provides good foam stability due to its ability to form visco-elastic interfacial films [843]. Egg white albumin, a mixture of proteins, is an even better foaming agent and foam stabilizer as it is highly surface active and produces a mechanically strong interfacial film. In fact, for practical pur- poses in food preparation the surface viscosity is too high to allow gas bubbles to be easily introduced. Some de-naturation causes a reduction in the surface viscosity but too much denaturation causes the protein to become insoluble [843]. For this reason cook-books will instruct a cook to continue beating until the foam produced is just stiff enough to stand up in well-defined peaks, but not beyond that point. Other food foam stabilizers include carbohydrates, such as polysaccharides, which proba- bly interact with proteins to help stabilize the foam films [124]. In addition, other emulsifiers, such as polysorbates, sorbitan esters may be added to help disperse the oil and also to help stabilize the foam [412]. Some cryogenic electron microscope images of food foams are provided by Wilson [73].

Food foams require different degrees of stability. Some foams only need to be stable long enough for the product to change form into a solid foam, such as with bread. During the cooking process, ingredients such as baking powder in the dough formulation decompose under heat to produce carbon dioxide, the gas that gener- ates the foam. The heat from the cooking also causes natural polymers in the food to cross-link, so that the product gels and the foam remains stiff enough to retain its

shape for the time it takes to complete the baking process. Other foods, such as whipped toppings, need to remain stable for longer periods of time.

Since proteins strongly adsorb at interfaces, very low concentrations (as low as 1 mg/L) can influence foaming. This can cause foaming where it is not desired, such as where it causes operational problems in fermentation processes [844]. Additives with fatty-acid chains generally tend to be capable of stabilizing foams, whereas those with unsaturated fatty-acid chains generally tend to destabilize foams [820]. Other food defoamers that have been used include oils, glycols and siloxanes [486,844]. Some commercial food defoamers are listed in Ref. [845].

These foams can also have complex rheological properties. Specialized methods have been developed to deal with the pronounced slip that can be exhibited by food foams [823]. Some food foams exhibit strong yield stresses, as in products that have been whipped to the “stiff peak” stage. Whipping air into egg white is an example. Baking the stiff foam that results produces meringue.

Foams stabilized with proteins, such as egg white, can be quite sensitive to the presence of oil (fat) droplets (see also Section 5.6.7). Just as is the case with foam sensitivity to oil in other industries, the presence of even small amounts of oil (0.03 mass % in foods [814]) can destabilize a foam. Oils such as lipids are thought to interfere with foaming by displacing proteins from the air-aqueous interface. One approach to improving the foam stability involves combining acidic proteins, such as whey or serum albumin, with basic proteins [814].

In the manufacture of marshmallows, gelatin is used to stabilize a foamed, hot liquid solution of sugar and water. Following casting or extruding, the foam is allowed to cool, causing the gelatin to gel (or set). Once set, the gelled pieces are dusted with starch and packaged as marshmallows (see pp. 476–478 in Ref. [845]).

Foams can also be involved in the drying of food products. A wide variety of foods, including fruits and vegetables, can be foamed and then spread out in thin layers on a support for “foam-mat drying” [633,845]. Other foods, such as milk, cream, and cheese can be dried by foaming them, then injecting the foam into a spray-drier. This process is called foam spray drying [633].

### 13.7.1

#### **Baked Products**

Some baked products originate as foams. Whipping air into egg white to the “stiff peak” stage then baking the stiff foam to produce meringue has already been cited as an example. A certain quantity of metal ion, such as copper, appears to contribute to the foam stability and resistance to over-beating [846], presumably related to the ability of copper cations to complex with the egg-white proteins (see also the similar possible role of iron in sparkling wine foams, Section 13.7.2). This could be why meringues are preferentially whipped in copper bowls.

Many other baked products, such as cakes, originate as both W/O emulsions and foams. Cake batter comprises a mostly W/O emulsion, with some O/W domains, that is also a foam containing small-sized air bubbles. Initially, the air bubbles are stabilized mostly by fat crystals. As the baking process gets underway the fat melts,

the W/O emulsion inverts, while the air bubbles remain in the aqueous phase [837]. As the temperature continues to rise the starch becomes increasingly hydrated, the egg protein begins to coagulate, and the air bubbles continue to expand due to incorporation of steam and carbon dioxide (from the baking powder) [837]. The air bubbles are usually stabilized by egg white, although gluten and flour lipids contribute to the foam stability in bread. Emulsifiers may be added to increase air incorporation, produce a finer dispersion of oil droplets, and increase the final cake volume.

Other such baked products include bread, rolls, buns, cookies, doughnuts, and puff pastries. The rheological properties of the dough are important in ways that go beyond just foam stability and holding shape during baking. For example, in the baking of breads the rheology of the dough affects the volume and texture of the breadcrumbs produced [215].

### 13.7.2

#### **Foam Toppings**

Whipped toppings, like whipped cream, are used on puddings, sodas, cakes, ice cream, fruit, and pastries. They are also used in cream pies. Consumer acceptance requires that this foam product be formulated to meet certain standards in terms of taste, consistency, and stability. Whipped topping starts out as an emulsion containing oil and surfactants [78]. When a dairy or non-dairy cream is whipped, air bubbles are introduced and also the shear removes some of the protective protein membrane coating the fat globules, making them more hydrophobic and causing them to become oriented at the air–water interface [827]. The air bubbles formed become stabilized by partly coalesced fat globules (liquid and crystalline) at the interface [78,812,835,847]. With sufficient whipping time and energy the air bubbles become progressively smaller, while the fat globules clump together, both leading to a high volume of fairly rigid foam. With too much whipping the stabilizing films become ruptured; the fat globule clumps become so large that they begin to cause the air bubbles to rupture and the foam begins to collapse.

Instant whipped cream is based on the same foam-stabilizing principles but is packaged as a liquid (emulsion) and a gas under very high pressure in an “aerosol can” (see the footnote to Section 15.5). When the can’s valve is released, the tremendous gas expansion through a fine orifice drives the formation of the foam topping. In non-dairy instant whipped topping products the cream is replaced by vegetable oil, water, and a number of emulsifiers, stabilizers, and preservative.

Factors thought to influence a whipped topping’s foam stability, taste, and texture include fat content, temperature, homogenization characteristics, and the presence of stabilizers and emulsifiers [847]. The nature of the fat component is also very important. Non-dairy whipped toppings contain oils such as palm oil or palm kernel oil. A commercial dairy cream might contain approximately 36% fat together with 64% non-fat milk solids, including emulsifiers and stabilizers. Regardless of the nature of the fat, it is thought to be desirable to have the fat be partly solid at 5 °C, semi-solid at ambient temperature, and liquid at body temperature (>37 °C) [847].

## 13.7.3

**Champagne and Beer Foams**

The foaming and bubbling character of champagne and other sparkling wines have become a symbol of numerous festive events. Champagne differs from other wines in that it undergoes a second fermentation to provide the carbonation needed for the bubbling and foaming properties. Originally produced by trial and error techniques, research and development has been applied to understanding and controlling the sparkling wine making process, including how to ensure the desired foaming characteristics.

The foaming capability and foam stability obtained from sparkling wines is usually tested by a dynamic foam stability method, as discussed in Section 2.6.2. Because these foams are evanescent and not really very stable, at least compared with the foams found in other industries, dynamic rather than static foam tests are the most suitable. In one version of the dynamic foam test, the Mosalux method, the foam heights are automatically measured using infrared beams and sensors [848].

Although a complex mixture of chemical species is present, it is thought that proteins and polysaccharides from the grapes used for wine-making are an important factor in foam formation and stability [848,849]. Polysaccharides [850] and proteins [849,851] have both been found to be key contributors to sparkling wine foam stability, in particular. However, little is known about the exact role of these proteins or other compounds that might impact foaming behaviour. The variety of grape used could also have an effect on foam formation due to differences in the concentrations and types of proteins and other species. It also appears that the extent of aging of the wine, especially in the presence of yeast, can have a significant effect on the foaminess [849]. Even a certain amount of iron appears to contribute to the foam stability [846], presumably related to the ability of iron cations to complex with the proteins.

The foam “head” created when beer is poured or dispensed, is an important aspect of consumer approval of a particular beer product. Compared with champagne foams, beer foams need to have different properties and be much more stable (beer foam needs to last for about five minutes). A cryogenic electron microscope image of beer foam is provided by Wilson [73]. Consumer preferences for beer foams vary, but can be characterized in terms of foam stability, quantity, lacing (adhesion to a glass surface), whiteness, “creaminess” (bubble texture), and concentration [852,853]. As a result, much work has been done in order to be able to control these properties.

The traditional kinds of physico-chemical characterization methods have been applied to beer foams, but potentially surface-active compounds in beer are so numerous, and their interactions so complex, that complete brewing and pouring/dispensing tests are still needed. There are also many foam stability tests available (see Section 2.6.2) but none has been universally accepted in this area [852]. Tests that employ “natural” pouring tend to be inconsistent, while those employing porous

foam generators, or other artificial means, produce foams that are not representative of the commercial product in actual use [852].

Unlike for champagne, whose foam film lifetimes are short (hydrodynamic control), beer foam has a slower drainage rate due to the adsorption of proteins at the interfaces and the generation of a significant disjoining pressure between bubbles [280]. A beer that has smaller bubbles of uniform size tends to have a more stable foam. The beer foam stability is generally increased by increasing concentrations of malt proteins (and/or propylene glycol alginate), metal cations (e.g.,  $Mn^{+2}$ ,  $Al^{+3}$ ,  $Ni^{+2}$ ), and hop iso- $\alpha$ -acids, whereas it is generally reduced by increasing amounts of lipids, protein modification, and ethanol [852–854]. In unpasteurized beer, enzymes such as proteinase A reduce beer foam stability [855]. Interactions between beer components also have an effect on foam stability, such as the cross-linking of malt proteins with polypeptides. In addition to stable foam, having the draining foam film leave the so-called “lace curtains” on the wall of a glass is another consumer-driven objective. The adhesiveness needed by the foam to produce this effect appears to be derived from the hops [428]. Other influences on beer foam stability include the addition of artificial foam stabilizers, and the nature of the packaging. Hegarty [853] describes the effects of the various beer brewing process steps on the ultimate quality of the beer foam. Another influence is the method of pouring or dispensing, whether from a can or bottle, or from a system used for draught dispensing [853]. Several reviews are available on beer (and champagne) foams [846,852–854,856].

#### 13.7.4

##### **Coffee Beverage Foam**

In coffee products, such as espresso, a stable foam is an important aspect of overall product quality, in addition to smell, taste, colour, and body [857]. In addition to appearance, a foam layer helps trap coffee aromas, providing a more gradual release. The degree of foaming has been found to increase with the degree of roast and the amount of protein in the coffee, while the stability of the produced foam has been related to the amounts of galactomannan and arabinogalactan [857].

#### 13.8

##### **Other Food Colloids**

Flavour microemulsions are used in clear products such as clear mouthwashes and clear beverages [842].

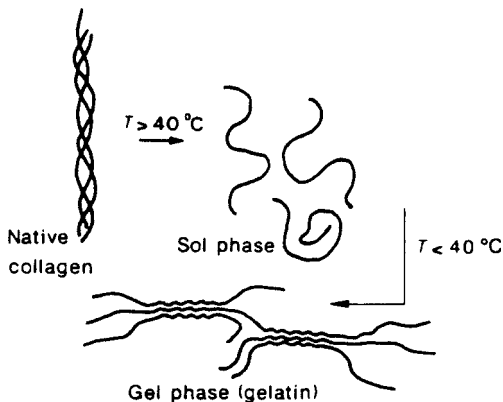
Chocolate is a solid-in-oil (S/O) suspension of non-fat particles (of about 10–100  $\mu m$  diameter) of sugar and cocoa (cacao) in a continuous phase of cocoa butter, which is the natural fat from the cocoa bean [215]. When cocoa beans are cleaned, roasted, cracked and ground, chocolate liquor results, a suspension of cocoa powder in cocoa butter. Depending on how much cocoa butter is removed (by pressing) one can make, in decreasing order of cocoa butter content: bitter, unsweetened, baking

chocolate, semi-sweet, sweet, and milk chocolate. Milk chocolate also contains milk fat and non-fat milk solids dissolved in the cocoa butter. White chocolate is cocoa butter (no cocoa powder) formulated with dairy, sweeteners, and other components. The rheological properties of chocolate are discussed by Sherman [215]. Chocolate drinks provide a related example of food suspensions.

Many other foods are mixed dispersions, like ice cream which is an emulsion, foam, and suspension. Others abound. Sausages and frankfurters may be considered to be “solidified” O/W emulsions in which the oil droplets are covered by a protein membrane and dispersed in a gel [293]. Similarly, cakes can be considered to be air bubbles dispersed in a gel phase.

Gelatin is the denatured form of collagen. Collagen is the most common protein in mammalian tissue, being a component of tendons, skin, bones, and cornea. It is a rod-like protein made of three strands wrapped together in a helix and stabilized by hydrogen bonds between the peptide linkages of neighbouring chains. At elevated temperatures, collagen denatures into the three separate strands, each taking up a random-coil configuration typical of other long-chain polymers in solution. As a result, an aqueous solution of collagen heated above 50 °C has a low viscosity. When cooled, the various chains begin to realign themselves into larger and larger helical sections, but rather than restoring the original collagen structure, the chains inevitably connect with others in a three-dimensional structure with the helical sections serving as the cross-links. This is illustrated in Figure 13.5 (Fig. 1 from Prost and Rondelez [774]). The final result is a gel, gelatin. The rheological properties of gelatin gels have been described by Sherman [215].

One way to prepare powder-flavoured products is by the spray drying of emulsified liquid flavour oils [842]. This process requires a stable emulsion so that oils do not separate before and during the spray-drying process. Since the various flavour oils have differing boiling properties some components are lost during this process resulting in reconstituted spray-dried products that will always taste slightly different from the original flavour [842]. Aerated topping powders, such as are used on



**Figure 13.5** Illustration of the denaturing and re-aggregation process of gelatin leading to gelation. From Prost and Rondelez [774]. Copyright 1991, Nature Publishing Group.



drinks or cakes, are spray-dried emulsions of hydrogenated vegetable fat [827]. Other spray-dried emulsions include coffee whiteners, cake and dessert mixes [858]. The original emulsions tend to be prepared using emulsifiers such as mono and diglycerides, lecithin, or fatty acid esters, and having the fat droplets stabilized (usually) by sodium caseinate. A related process is spray chilling (spray congealing) in which there is an actual phase change, from liquid to solid. This can be used to encapsulate, separate, and protect liquid food additives and flavours in a solid. The spray-chilled products melt upon heating, releasing their contents [842]. Examples of spray-chilled products include bakery products, dry soup and gravy mixes, and microwaveable foods.

Surfactants are involved in the production of many common food items and can be found in the extraction of cholesterol, solubilization of oils, liquor emulsification, prevention of component separation, and solubilization of essential nutrients. Surfactants are also a key component in the manufacture of edible coatings. A finish coat or polish may be added to chocolate and sugar-panned confectionery products to produce an aesthetically pleasing gloss. These are commonly ethanol-based shellac and corn zein coatings, but may also include water-based whey proteins [859]. Surfactants are added to create a dispersion of the coating particles, which then allows for proper wetting and adhesion over the candy surface. A problem with chocolate blend coating is “bloom” where the fat crystallizes and the cocoa butter separates [839]. Crystal modifiers, emulifiers such as distilled monoglycerides, lactic acid esters of monoglycerides, sorbitan monostearate and polysorbate 60, are added to stabilize the fat. The latter may also be used to increase the palatability of the confection by forming an emulsion between the fat and mouth saliva, which minimizes the waxy-mouth-feel [839].

In the processing of food products there are a number of cases in which unwanted foams are produced. For example, in the manufacture of sugar from sugar beets the use of high flow rates, the natural ability of sugar solutions to foam, and sometimes the use of high pressures can all combine to create foam-induced processing problems. As with other process industries the foam-related problems are usually interference with desired mixing and reactions, difficulty controlling process vessels, or foam-over. Figure 13.6 shows where antifoams are added in a sugar beet processing plant. There are several key stages of the process requiring antifoams, and with specific antifoams being needed for different process stages. During hydraulic transportation and washing, foam tends to be stabilized by natural surfactants from the beets themselves, like saponins, and by natural surfactants from soil clinging to the beets [860]. Antifoams used in these process stages include copolymers having low cloud points relative to the typical washing temperatures (~ 5–15 °C), such as polyalkyleneglycol co-polymers. The sugar extraction (called “diffusion” in this industry) is accomplished by continuous counter-current solid-liquid extraction in hot water. During and right after, sugar extraction, foams tend to be stabilized by sucrose, other carbohydrates, mono, di, and tricarboxylic acids, and other components extracted from the beets [860]. Antifoams used in these process stages include polyoxyethylenes, propylene glycols, and polyoxyethylene co-polymers [860].

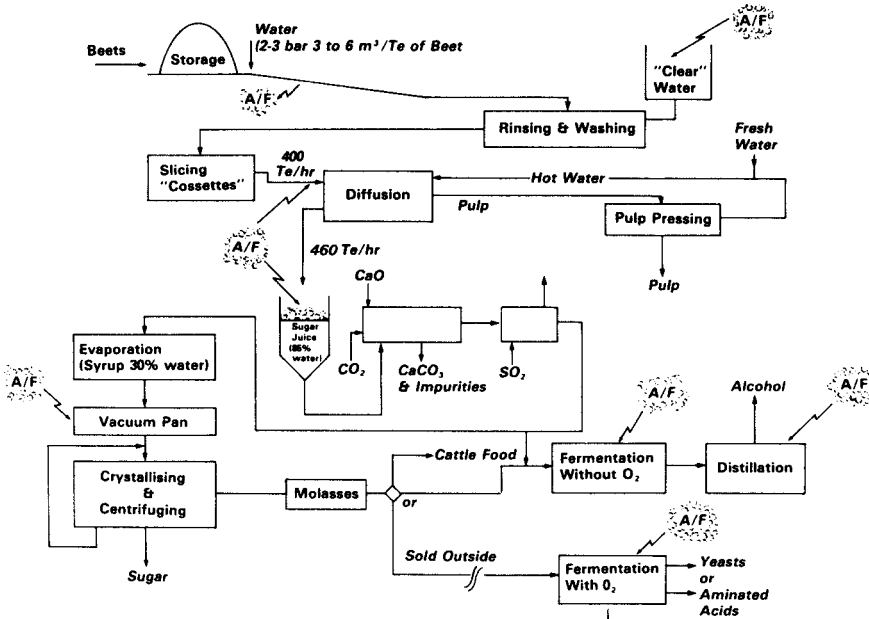


Figure 13.6 Illustration of continuous sugar beet processing showing the key stages for which antifoam addition (A/F) is required. From Blease *et al.* [860]. Copyright 1993, Dekker.

13.9 Introduction to Agricultural Colloids

Table 13.3 provides some examples of agricultural colloids. Beyond foods and the processing of agricultural products into foods, as covered in the previous sections of this chapter, there is a range of crop-protection products. These include pesticides and foam blankets. There are several books and reviews related to agricultural colloids [861–864].

Table 13.3 Some emulsions, foams, and suspensions in agriculture\*.

Emulsions	Pesticide, herbicide and fungicides	O/W, W/O/W
Foams	Plant and shrub blankets	G/W
	Waste blankets	G/W
Suspensions	Pesticide, herbicide and fungicides	S/W

\* Dispersion abbreviations include liquid (L), water (W), oil (O), gas (G), and solids (S).

Pesticides are substances that repel, kill, or otherwise control unwanted animals or plants. Examples include insecticides, fungicides, and herbicides. The formulation of pesticides is significant in terms of product stability and product perfor-

mance. The current trend in crop protection is towards products that are more potent, safer to user, having less impact on the environment, are more convenient to use and have improved efficiency of the applied product [865]. In the case of sprayed products, colloid and interface science impacts all aspects of application. First, spray droplets impact the leaf surface, creating a foliar deposit from which the pesticide moves into the leaf or contacts the pest (see Figure 13.7) [865]. The spray pattern is influenced by the applicator nozzle hydrodynamics, the physical properties of the spray fluid, and the movement of the sprayer vehicle.

In order for a pesticide to be effective it has to come into contact with the organism it was designed to control, be taken up from the surface of the organism and transported or diffused to the location in the organism where it will be effective, and move to and bind to the molecular site of action [865]. The formulation influences impact and retention or spreading of the droplets, the residence time of the deposit, and the availability of the active ingredient to move into the plant. External factors such as temperature, humidity, wind, sunlight and rainfall also play roles in the efficacy of the product [865].

Suspension concentrates, or flowables, are highly concentrated (30–60%) suspensions, stabilized by surfactants, that are intended for spraying. They are easier than powders to handle and disperse prior to use, they produce no dust, and are easy to dilute. Here, finely-divided, solid, active ingredients are dispersed in water, relying on the wetting and stabilizing abilities of a suitable surfactant to prevent precipitation, hydrolysis, and flocculation over long periods of time [193,225]. These surfactants are usually anionic, such as an alkyl diphenyl ether disulfonate [193], or non-ionic, such as ethoxylated alcohols, alkylphenols, sorbitan, and alkylamines [866]. Organosilicone surfactants can exhibit improved surface tension lowering (for



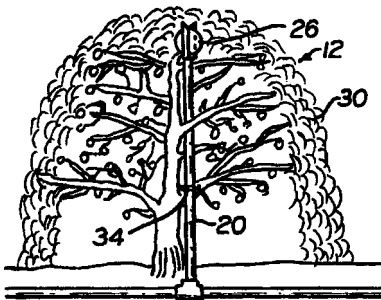
**Figure 13.7** Illustration of processes influencing the performance of a crop protection product. Spray droplets impact a leaf surface, and create a foliar deposit from which a pesticidal agent can move into the leaf or contact the fungal or insect pest. From Rodham [865]. Copyright 2000, Elsevier.

improved leaf wetting) and low dynamic surface tension (for spray-drop retention on leaves), and are used in some commercial spray-application products [866].

Some agrochemicals are formulated as emulsifiable concentrates. Here active ingredients that are not very soluble in water are dissolved in a solvent that is, in turn, emulsified into the aqueous phase, either in the concentrate itself (an emulsion concentrate) or else upon dilution in the spray tank [865]. Some emulsion concentrates are designed so that when water is added to them they spontaneously emulsify to form an O/W microemulsion [225].

Microencapsulation can be used to provide a temporary barrier between a chemical species and its surrounding environment( see also Section 14.3). This permits controlled (slow) release of the active agents following application. Depending on the product and the situation, an active ingredient such as a pesticide may need to be released slowly at low concentration, or slowly at high concentrations. Such controlled release can both reduce the number of crop applications that are required and also help prevent over use and subsequent run-off. The barrier can be provided by a polymer film, in the case of suspensions [867], or a liquid membrane, in the case of single or multiple emulsions [865]. Microemulsions have also been used [234,865].

The application of foam blankets as temporary covers for environmental applications was introduced in Section 9.6. Several kinds of foams have also been developed for use as temporary insulating blankets to cover crops such as fruits, vegetables, and even small, delicate trees to protect them from unseasonal frosts [868–873]. Such foams would be applied as a thick coating (about 2–7 cm), preferably in a way that not only surrounds the plants but also drapes down to the ground [872,874]. The foam also has to be able to bridge between leaves and branches. Figure 13.8 provides an illustration. The foam blanket would be applied in the evening when there is a freeze or frost warning, would be sufficiently stable to provide insulation during the night, then break by sunrise. These foams naturally have to be non-toxic to the



**Figure 13.8** Illustration of the application of a foam blanket to protect a small tree. A tube (20) is clamped (34) to the trunk and positioned so that foam can be pumped through a nozzle (26) over the top of the tree. From this point the foam provides a blanket covering branches (30) and the spaces between branches (12). Note that the blanket also drapes all the way down to ground level. From Cole and Beattie [874].

plants or trees they are intended to protect. In order to adhere to foliage and have the necessary stability, such foams are usually polymer thickened [868–870,872]. Secondary benefits of this kind of foam blanket include humidification and greater water retention by the plants.

Other agricultural applications of foam blankets include prevention of erosion and distribution of soil particulates by wind [589], and reducing ammonia and odour emissions from intensive feed-lot operations, such as in hog-farming operations, by blanketing waste slurries, both in animal houses and spread over fields. Here a cover is needed that will allow passage of fresh wastes, or rain, and that can be easily re-formed, although the foam has to be stable in the presence of ammonia. Applications of foam blankets in areas beyond the agricultural sector are discussed in Sections 9.7 and 10.5.

## 14

**Biological and Medical Applications**

## 14.1

**Introduction**

A range of emulsions, foams and suspensions can be found in biology and medicine. In fact, the human body alone contains a range of suspensions, emulsions, and sometimes foams. Some examples are given in Table 14.1.

**Table 14.1** Some emulsions, foams, and suspensions in biology and medicine\*.

Emulsions	Blood	O/W
	Vesicles, vacuoles	W/W, W/W/W
	Emulsion encapsulated drugs	O/W, W/O, W/O/W
Foams	Gastrointestinal foam	G/W
	Spermicidal foam	G/W
Suspensions	Polymer encapsulated drugs	S/W
	Biodegradable drug suspensions	S/W
	Diagnostic suspensions	S/W

\* Dispersion abbreviations include water (W), oil (O), gas (G), and solids (S).

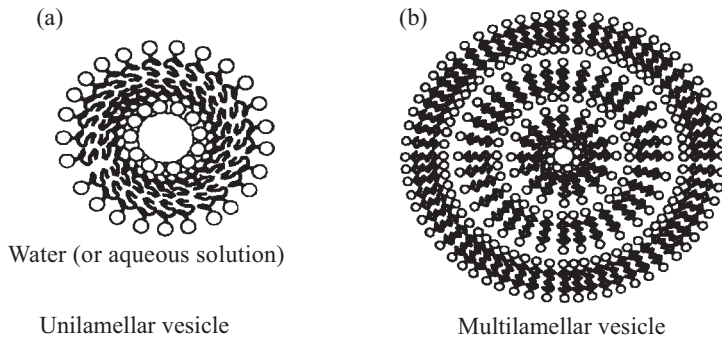
Whole blood contains plasma, which is essentially an aqueous solution of proteins, in which are dispersed several kinds of cells or particles:

- red blood cells (erythrocytes), which carry oxygen throughout the body, are usually about 6–8  $\mu\text{m}$  in diameter and reasonably monodisperse;
- white cells (leukocytes), which fight infections. These are slightly larger than red cells, usually about 10–15  $\mu\text{m}$  in diameter; and
- platelets, which play a role in blood coagulation and wound healing.

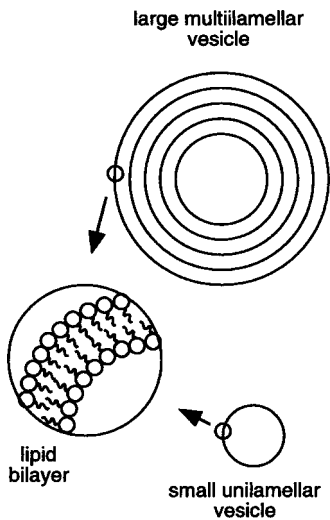
Viruses are much smaller, being about 20–300 nm. Aggregation phenomena are important in virus suspensions because irreversible aggregation of virus particles results in precipitation and loss of biological activity. Conversely, a key challenge in the development and commercial production of viruses for human gene therapy

is to maintain virus infectivity, including maintaining stability of the suspension, during long-term storage [875].

One of the several shapes that micelles can take is laminar. Since the ends of such micelles have their lyophobic portions exposed to the surrounding solvent, they can curve upwards to form spherical structures called vesicles. Vesicles are spherical and have one or more surfactant bilayers surrounding an internal pocket of liquid. Multi-lamellar vesicles have concentric spheres of uni-lamellar vesicles, each separated from one another by a layer of solvent [193,876] (Figure 14.1). The bilayers are quite thin (~10 nm) and are stabilized by molecules such as phospholipids, cholesterol, or other surfactants (Figure 14.2). Vesicles made from phospholipid bi-layers are called liposomes. Liposomes can be made by dispersing phospholipids (such as lecithin) into water and then agitating with ultrasound.



**Figure 14.1** Unilamellar and multilamellar vesicles. From Rosen and Dahanayake [193]. Copyright 2000, American Oil Chemists Society.

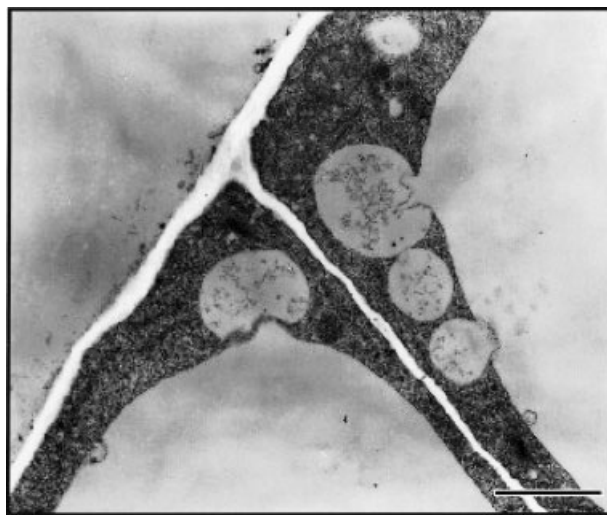


**Figure 14.2** Illustration of a large multilamellar liposome (top) and a small unilamellar liposome (bottom). In each case lipid bilayers are the structural units (inset). From Yang and Alexandridis [890]. Copyright 2000, Elsevier.

In uni-lamellar vesicles there is a single spherical layer of lamellar micelles surrounding a core of solvent. Such uni-lamellar vesicles tend to have diameters in the range of about 30–100 nm, much larger than the normal size of micelles. Vesicles can easily have lifetimes ranging from days to months. Vesicles can be about the same size as living cells [629] but have a much simpler structure. As an example of surfactant self-assembly, the ability of biological amphiphilic molecules to aggregate into spherical and non-spherical clusters, i.e., vesicles, may have been important for the development of early living cells [194]. Cellular biological membranes in plants and animals do share features with these colloidal systems, although the membrane structures and their properties are more complex [194,877–879]. Nevertheless, vesicles are used in research as model systems for blood and other living cells, as reviewed by Prost [629].

Vacuoles are large vesicles used in cells. Vacuoles in plant cells store nutrients, metabolites, and waste products, and maintain the shape and structure of the cells. Figure 14.3 shows an example of vesicles interacting with a vacuole [880].

There are also several examples of natural surfactants and foams in the human body. The understanding of the pulmonary surfactant system, although discovered in 1929, has only been applied clinically since about 1990 for the treatment of respiratory distress syndrome. Surfactant replacement therapy may also be used in treating other forms of lung disease, such as meconium aspiration syndrome, neonatal pneumonia and congenital diaphragmatic hernia [881]. Lung surfactant, composed of phospholipids and proteins [882,883], is necessary to maintain a low surface tension at the alveolar air–liquid interface. When there is a deficiency of surfac-



**Figure 14.3** Transmission electron microscope image showing vesicles fusing with and emptying their contents into the vacuole of a *vitis vinifera* (grape) cell. The scale bar = 2  $\mu\text{m}$ . From reference [880]. Copyright 2003, Agriculture and Agri-Food Canada.



tant, the high surface tension of the thin aqueous layer lining the respiratory epithelium of the lungs would cause alveolar collapse at the end of expiration. Conversely, a reduced surface tension tends to keep alveolar spaces small, it counteracts alveolar expansion during inspiration and supports alveolar retraction during expiration [881,883]. In fact, the surface tension responds dynamically to changes in alveolar radius, to a plateau value of below 10 mN/m, in order to maintain constant alveolar pressure throughout the ventilatory cycle [883]. The lung surfactant system may also protect the lung from injury and infection caused by inhalation of particles and micro-organisms [881,883]. Details of lung surfactant composition, function and clinical studies are given in several reviews [881–883].

Foams can occur in the intestines where they may cause indigestion, pain, and/or a sense of being full, collectively known as dyspepsia [884]. Pharmaceuticals designed to combat dyspepsia usually contain antifoams, antacids, and possibly enzymes [884]. The most common antifoams seem to be polymethylsiloxanes (referred to as dimethicone in pharmaceutical literature [884]) mixed with hydrophobic particles, such as hydrophobic silica. The formulation is delivered as a tablet, suspension, or emulsion (simethicone tablets; simethicone oral suspensions; simethicone emulsions). Foams can also be used to administer drugs, such as in contraceptive foams.

Pharmaceutical products often contain uniform, suspended, colloidal-sized particles of a drug in a liquid. For example, penicillin is often delivered as a suspension of procaine penicillin G suspended in an aqueous polymer solution [215]. Maximizing the surface electric charges (i.e., maximizing zeta potential) is often used to achieve a very high degree of stability against both aggregation and sedimentation, in order to achieve a long shelf-life. Other products are formulated to contain a suspension that will become weakly flocculated, but not coagulated into a tight sediment, upon standing, but which is easily broken up and re-dispersed upon gentle shaking of the bottle. Minimizing the surface electric charges (i.e., reducing the zeta potential to zero or almost zero) is used in this case. In addition to being encapsulated in various ways, many drug molecules are themselves surface active [885].

In addition to suspensions, pharmaceutical products may be emulsions or foams. In any case the rheological properties have to be tailored to suit the nature of the application [215]. Therapeutic ointments are usually not very viscous and encounter only moderate shear rates upon application, about  $125\text{ s}^{-1}$  when gently smeared on with fingers, and about  $210\text{ s}^{-1}$  when smeared on with a spatula [215]. An ophthalmic ointment is usually very soft, with a viscosity of about 20–30 mPas, whereas a medicated ointment needs to be soft enough to apply easily but stiff enough to remain on the area to which it was applied, with a viscosity of about 30–40 mPas [215]. A protective ointment like zinc oxide paste needs to be hard and stiff enough to stay in place where applied, even when moist.

Possibly the most effective way to control the distribution of drugs in the human body is to encapsulate them in microscopic or submicroscopic drug carriers of some kind. Although many common pharmaceutical formulations lead to a rapid release of the drug, such drugs are often rapidly removed from the body as well. This means that keeping a drug concentration at a value that provides therapeutic benefit can

require multiple doses. An alternative is to provide the drug in a form that controls the delivery of the drug to a targeted site in the body and also controls the rate of delivery of the drug at that site. Microencapsulation is a means of providing a barrier between a chemical species and its surrounding environment. The barrier may be needed to contain a solubilizing liquid for the therapeutic agent, to prevent hydrolysis or enzymatic degradation, to shield the agent from non-targeted tissues, to control drug release, or to target specific sites for delivery [52,876,886]. For example, protein drugs need both protection and carriage across biomembranes [876]. Drugs encapsulated in nanoparticles could potentially cross the endothelial cells that protect the brain and permit treatment of neurodegenerative diseases such as Alzheimer's and Parkinson's. The transport and release of microencapsulated drugs can be controlled by the physical and chemical properties of the drug carriers, which can be designed for specific purposes. Of course, microencapsulation can provide a means of transporting, and controlling the release of, chemical species in a variety of applications beyond pharmaceuticals, including cosmetics and agrochemicals [236] (see also Sections 13.9 and 15.3). The microencapsulating barriers can be:

- a liquid membrane such as that in a vesicle, in which case chemical release is controlled by diffusion and dissolution;
- a polymer film, in which case chemical release is controlled by wall thickness and the nature and properties of pores in the film, if any, or by biodegradation; or
- an emulsion or multiple emulsion, in which case chemical release is controlled by diffusion and coalescence.

## 14.2

### Vesicle Carriers

Vesicles and liposomes, with their bi-layers and ability to form multi-lamellar structures, were introduced in Section 14.1. Being about the same size as living cells permits such species to be transported throughout the body. Although liquid exchange can take place through the membrane, it can be very slow and the membrane can be permselective for certain species. As a result, the bi-layer(s) provide a permeability boundary that allows vesicles or liposomes to be used to encapsulate any or all of: hydrophilic, hydrophobic, and surface-active agents, especially hydrophobic species in the hydrocarbon core of the bi-layers, and hydrophilic species in interior aqueous layers. For this reason, vesicles can be used as drug delivery vehicles by providing a means of internally solubilizing pharmacologically active species, and then controlling drug release, degradation and bioavailability [885].

Liposomes are being used in both cosmeticeuticals and pharmaceuticals [887,888]. An example is the use of liposomes to carry a drug to specific disease locations, such as tumours, rheumatic arthritis, and inflammation sites [236,885,887]. Another example is the use of liposomes in topical and dermal lotion or cream treatments, in which they are intended to carry agents such as anaesthetics, retinoids,

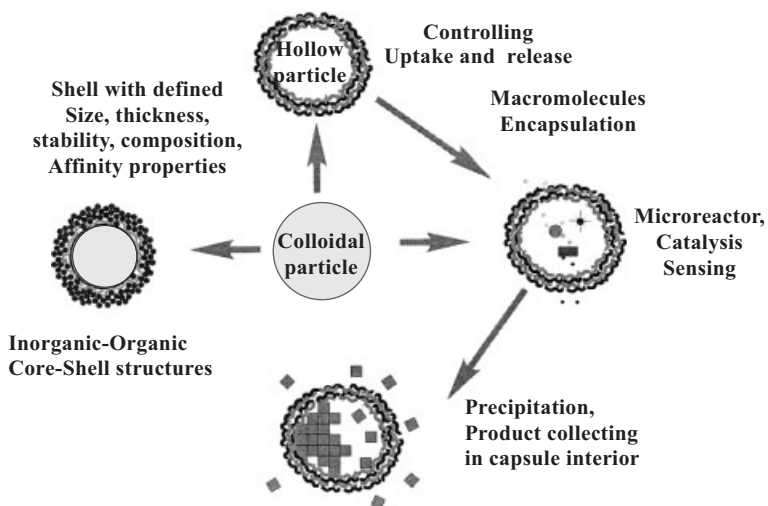
and corticosteroids through the *stratum corneum* and then deliver them at appropriate concentrations [885]. A related carrier is a suspension of solid lipid particles (in which lipid O/W emulsion droplets are prepared then cooled to the point of solidification) [885].

Some limitations of liposomes include drug-induced instability of the liposome itself, drug leakage, and limited shelf-life [889]. Liposome carriers are also more complicated to formulate and maintain than conventional emulsions and are subject to having their bi-layers disrupted. The most common means of providing liposomes with stability against aggregation and bi-layer disruption is by steric stabilization, using lipids with large sugar headgroups or lipid-associated polymers [888]. With steric stabilization in place, liposomes can have prolonged circulation times in the bloodstream [888]. The size of the liposomes ranges from 20 nm (unilamellar vesicles) to as large as several  $\mu\text{m}$  (multilamellar vesicles) [876].

### 14.3

#### Polymer Coatings

Polymer-based colloidal drug delivery carriers include polymeric micelles, nano- and micro- particles, or coated particles, and hydrogels [886,890,891]. These are being developed for vaccines and anti-cancer drugs, for targeting of specific treatment sites within the body, and as vehicles for ophthalmic and oral delivery. Methods for the creation of multi-layer coatings are reviewed by Sukhorukov [892] (see also Figure 14.4). Numerous examples are cited by Ravi Kumar [893].



**Figure 14.4** Illustration of the use of a colloidal particle substrate and step-wise coatings to create different kinds of capsules. From Sukhorukov [892]. Copyright 2001, Elsevier.

**Example.** Particles of about 100 nm diameter poly(lactide-co-glycolide) have been precipitated from an O/W emulsion, then coated with poly(propylene oxide)–poly(ethylene oxide) block co-polymer (PPO-PEO) [893]. The polymer coating adsorbs onto the particles with the Ppo chains facing inwards and the PEO chains facing outwards into aqueous solution, providing steric stabilization. The PEO chains are thought also to enhance the adsorption of some plasma compounds that disguise the particles so that they are not recognized by macrophages as foreign bodies and therefore are not attacked by them [893]. This prolongs the lifetime of the particles in the circulating bloodstream and could provide a combination of storage capacity and slow release.

Polymeric micelles have emerged as drug delivery carriers for poorly water-soluble drugs (often protein-based) because they can solubilize the active component in their inner core, protecting it from contact with the surrounding aqueous environment. The micelle shell provides stabilization in the aqueous environment and interacts with plasmatic proteins and cell membranes. Micelle formation of block co-polymers is driven not only by hydrophobic effects, but by electrostatic interaction or intermolecular hydrogen bonding, leading to the formation of polyion and polypeptide micelles [890]. Surface properties of the block co-polymer micelle carrier can also be optimized to selectively improve properties such as biocompatibility, biodistribution, and residence time [890]. Drug-release kinetics must be modified so that once below the cmc, the micelle will still be stable enough to reach the target tissue before dissociating. Details of polymer-based colloidal drug systems can be found in several reviews [887,890,891,893].

Both complex coacervation and interfacial polymerization can be used to create a polymer coating. Complex coacervation involves a phase separation that results from the formation of a complex between oppositely charged polyelectrolytes. At a pH below its isoelectric point, gelatin, a positively charged collagen hydrolysis product, has been widely used in complex coacervation with anionic species like gum Arabic, pectin, and alginate. This approach has been used to prepare “scratch and sniff” strips [842] and to protect vitamins from oxidation [894]. With rising concerns regarding prion diseases, research is being conducted to find alternatives to agents like gelatin and albumin, such as vegetal proteins [894]. Suspensions of biodegradable particles can be prepared so that the drug release occurs as a result of the degradation [885]. Polymer coatings such as poly(carbophenoxyvaleric acid) and various polyethylene oxide-based compounds have been used for this purpose. These biodegradable polymer-coated drug particles have been used in applications like oral vaccines [885].

Another means of drug delivery involves the encapsulation of a drug in a biodegradable, biocompatible, non-antigenic polymer coating [889]. Here, the size has to be very carefully controlled in order to avoid blocking capillaries. For example, particles greater than 7  $\mu\text{m}$  are filtered out by the capillary bed in the human lung and will not naturally gain access to the blood circulation system [889]. Particles smaller than about 200 nm can gain access into bone marrow whereas larger particles are essentially filtered out [889]. This has led to the development of drug-containing col-

colloidal-sized particles, which are becoming popularly known as nanoparticles [889]. If produced by emulsion methods, we get drug-loaded particles that are about 200–1000 nm. If produced by polymerization of monomers in W/O microemulsions then one can obtain even smaller, drug-loaded, particles that are smaller than 200 nm. The wettability also influences the distribution of polymer microcapsules in the body. For example, hydrophobic particles tend to be sequestered in the liver [889]. Thus, adjustment of the size and wettability of the polymer microcapsules can have a great influence on their ultimate distribution in the body.

**Example.** Interfacial polymerization can be used to microencapsulate a lipophilic drug. In this case the drug is placed in an oil phase together with a hydrophobic monomer. A surfactant would be added and a mechanical stirrer used to prepare an O/W emulsion. At this point the drug and the hydrophobic monomer reside in the dispersed oil droplets, whose droplet size distribution, and therefore the ultimate capsule size distribution, has been controlled by the nature and concentration of the emulsifying surfactant. A hydrophilic monomer is dissolved in the aqueous phase and the two monomers interact at the oil/aqueous interface to create polymer films that form the capsule walls. The thickness of the capsule walls can be controlled through the selection and concentration of the monomers. The amount and distribution of pores in the capsule walls can be controlled through the use of cross-linking agents. For a hydrophilic drug, all of the above could simply be inverted.

#### 14.4

##### Emulsion Carriers

Several types of emulsion can be formulated to be compatible with particular body fluids, to solubilize and deliver specific agents such as drugs, and to provide controlled release [885,895]. Thus W/O emulsions can be used for intramuscular injection of vaccines, where having the vaccine in the aqueous phase helps retard diffusion from the point of injection into surrounding body fluids. O/W emulsions, on the other hand, can be used for intravenous injection of nutrients, lipophilic drugs, and vitamins [895]. For example, O/W emulsions stabilized by non-ionic surfactant have been proposed for use in the prevention of influenza virus infection *in vivo* [896]. Here the stabilizing surfactant is also the antimicrobial agent, while the role of the emulsion droplets is to deliver significant concentrations of surfactant without being toxic to eukaryotic cells. To make the emulsion droplets even more stable they can be treated with colloidal-sized particles that adsorb and self-assemble to form coatings that can be made mechanically strong by, for example, sintering [897].

Other drug-delivery systems may include double emulsions, usually W/O/W, for transporting hydrophilic drugs such as vaccines, vitamins, enzymes, hormones [441]. The multiple emulsion also allows for slow release of the delivered drug and the time-release mechanism can be varied by adjusting the emulsion stability. Conversely, in detoxification (overdose) treatments, the active substance migrates from the outside to the inner phase.

Microemulsions, having very small droplet diameters, can provide species small enough to be transported through the smallest of human capillaries ( $\sim 5 \mu\text{m}$ ). Moving to still smaller sizes, micelles can be used to transport oil-soluble drugs for intravenous injection, while targeting specific cells or organs. Such micellar capsules have been recovered from plasma several hours after intravenous injection [891]. The foregoing provides a broad range of approaches to microencapsulation.

**Example.** A multiple emulsion can be created by, for example, first making a stable “primary” O/W emulsion using a high HLB surfactant and a mechanical stirrer. The primary emulsion is then itself emulsified into an oil phase that contains a low HLB surfactant, this time employing gentle, low shear agitation. The result is an O/W/O multiple emulsion. Some care is needed in the selection of the two emulsifying surfactants. The first surfactant (high HLB) should provide a strong interfacial film in order to protect the droplets during the subsequent preparation steps, and also later, during storage. The second surfactant (low HLB) should provide a barrier to aggregation and coalescence. A polymer coating on the exterior surfaces of the O/W/O droplets can provide additional stability [236].

Microemulsions have an inherent (thermodynamic) stability advantage over macroemulsions. Some additional advantages are reviewed by Schwuger *et al.* [226]. However, although thermodynamically stable when prepared, even microemulsions can lose their stability upon storage and handling as a result of chemical degradation of any of its constituent chemicals, or due to induced changes to any properties crucial to that stability, such as temperature, pH, dilution with water or electrolyte solution [885]. Microemulsions are typically used for topical and oral applications as opposed to parenteral, due to toxicity and dilution concerns regarding the latter use (many microemulsions are not stable when diluted with water) [885]. As is the case with macroemulsions, O/W microemulsions can be used to increase the solubility of insoluble or slightly soluble hydrophobic drugs, such as cyclosporin. When applied topically, O/W microemulsions can also enhance the transdermal penetration of drugs. Several reviews are available [234,885].

The ability to encapsulate active ingredients in emulsions, foams, and suspensions, is leading manufacturers to make personal care products that are also pharmaceutical, termed cosmeceuticals. Examples creams with anti-wrinkle properties, lotions with anti-baldness effects, and sunscreens that treat skin damage (see also Chapter 15).

A related use of multiple emulsions is in the preparation of microparticles of water-soluble drugs [52]. In the solvent-evaporation method (also known as the “in-water drying method”) a water-soluble drug is first formulated into a W/O emulsion. This emulsion is then made into a W/O/W multiple emulsion with the aid of a suitable second surfactant, as described in the preceding example. The water is then evaporated off leaving dry microparticles that are readily stored and reconstituted. This technique has been used to prepare, for example, biodegradable hydrophobic microspheres containing hydrophilic pharmaceuticals [52]. Advantages of such encapsulating microparticles are their small size (on the order of 100 nm) and, in some cases, their bioadhesive properties which help ensure that the encapsulated

pharmaceutical agents are transported to the desired location and held in place long enough to achieve a reasonable degree of bioavailability [898].

Multiple emulsions have been used to deliver active agents with prolonged release in dermatological treatments. For example, O/W/O emulsions have been used to deliver pilocarpine hydrochloride as a myopic agent in eye infections [440]. Here the active agents was placed in the internal oil phase of the O/W/O emulsion to provide an appropriate rate of release. Similar approaches have been used in other treatments, using W/O/W emulsions [440].

Lipid drug emulsions are O/W emulsions that can be compatible with blood and therefore can be used for intravenous injection of nutritional fats, lipophilic drugs, and vitamins [885,895]. Lipid drug emulsions can deliver such agents as oxygen, sedatives, anesthetics, fatty acids, vitamins, platelet inhibitors, and diagnostic imaging agents, sometimes in combination. The use of such emulsions can help avoid the need for organic solvents that can be associated with pain on injection, can reduce or prevent losses of active agents due to adsorption, and can provide controlled release and/or directed release (release only to selected organs) [895]. The oil is usually mostly composed of triacylglycerols. Emulsifiers such as egg yolk phospholipids are commonly used to stabilize submicrometre-sized (about 0.2–0.6  $\mu\text{m}$  diameter) emulsion droplets, acting via both electrostatic and steric repulsion forces. This can create emulsions having shelf-lives on the order of 18 months (at room temperature). Lipid nano-sphere emulsion drug carriers have been developed using soybean oil and egg lecithin [899]. These nano-emulsions have droplet diameters in the range 25–50 nm (ten times smaller than conventional microsphere emulsions used for intravenous nutrition). These much smaller sized emulsion carriers may provide advantages in both biocompatibility and in their potential for site-specific targeting.

## 14.5

### Colloids in Diagnostics

Several applications of colloidal dispersions are being made in the area of medical diagnostics. Polymer particles with specific surface coatings can be used to develop specific diagnostic testing systems. An example is in the diagnosis of meningitis, for which latex particles coated with an antibody can be used to detect the antigen in cerebrospinal fluid [236]. When the antigen interacts with the antibodies, the latex particles agglutinate, which can be observed under a microscope.

During gastrointestinal endoscopy foam bubbles, among other things, can obstruct visibility, especially when using chromoendoscopy or endoscopic ultrasonography [900]. To deal with this pre-medication including an anti-foaming or defoaming agent, such as dimethylpolysiloxane (see also Section 7.2.2), may be prescribed.

There are also some potentially new diagnostic applications for nanoscale dispersions of droplets or particles. For example, gold nanoparticles can be bound to an oligonucleotide that is capable of binding to a target polynucleotide associated with a particular disease. When these species come together and bind to each other their

dispersion changes colour from the red of a classical gold particle dispersion towards blue, the colour of a dispersion of gold particles in close proximity to each other, thus providing a visible, positive diagnostic test [76].

If the nanodispersed species have sizes of the order of 10 nm, diagnostic agents encapsulated in such nanoparticles could potentially cross into human cells. For example, 10 nm diameter, silica-coated, cadmium selenide crystals have been able to transfer into vesicles and be transported by them [901]. These protein-sized particles fluoresce for long periods of time making them potentially useful for diagnostic labelling.





## 15

## Personal Care Product Applications

## 15.1

## Introduction

Personal care products include shampoos, skin care products, hair conditioners, toothpastes, shaving preparations, hair-styling aids, and bath preparations. Almost all of these are emulsions, foams, suspensions, or combinations of these. Some examples are given in Table 15.1. Although consumer acceptance is vitally important for any commercial product, the success of a personal care product can be determined as much by its appearance as by its effectiveness. Accordingly, great efforts go into formulating products that are functional, stable, easy to apply, and have a particular appearance. For example, a number of personal care products are formulated so that the dispersed components and the continuous phase all have very similar refractive indices. As mentioned in Section 2.2.3, this prevents light scattering and ensures that such products appear to be completely transparent. In addition to the list of key features just presented, some personal care products are now being formulated that have pharmaceutical benefits as well. These are termed cosmeceuticals (see also Section 14.3).

**Table 15.1** Some emulsions, foams, and suspensions in personal care\*.

Emulsions	Cosmetic and skin care creams	W/O, O/W, W/O/W
	Microemulsion hair dyes	W/O
Foams	Shampoo foam	G/W
	Hair-styling mousse	G/W
	Shaving-cream foam	G/W
Suspensions	Exfoliating scrubs	S/W
	Facial masks	S/W
	Lipsticks and lip balms/glosses	S/O

\* Dispersion abbreviations include water (W), oil (O), gas (G), and solids (S).

## 15.2

**Detergents, Shampoos and Conditioners**

The principles outlined in Section 3.6.6 apply to both the removal and anti-redeposition of soils, and to detergency in both industrial and personal care situations. There are, however, some differences between the application of detergency in an industrial setting (Section 12.2.1) and in a household setting. For example, whereas industrial cleaning usually involves hard surfaces that cannot mechanically hold soil, fabrics can hold soil mechanically, even after the soil has been removed from the fibre surfaces. In addition, fabrics can usually swell in aqueous solution, are permeable to small molecules, and may contain charged or polar surface groups that can interact with soil. An effective shampoo or skin cleaner needs to displace dirt and keep it dispersed so it does not redeposit before the hair or skin can be rinsed.

The work of adhesion was introduced in Eq. (3.26) (Section 3.6.6) to emphasize the role of detergent in lowering  $\gamma_{D/W}$  and  $\gamma_{S/W}$ , thus reducing the amount of mechanical energy required to dislodge dirt. A simple illustration of the correspondence between the surface energy (work of adhesion) and soil removal is shown for two model samples of “dirt” in Table 15.2. Here, the removal was based on the rolling-up and detachment of oil drops from a flat surface of solid paraffin, after gentle submersion in washing liquid [902]. In the experiments represented by Table 15.2 the surface energy relationships, as represented by the work of adhesion, are clearly important, but the two kinds of “dirt” were removed by slightly different mechanisms. In both cases wettability was a factor, but the 1-hexanol was removed by simple rolling-up and detachment, whereas the 1-hexanoic acid was removed through progressively decreasing droplet size due to a combination of emulsification and solubilization into the aqueous phase.

**Table 15.2** Illustration of detergency and the work of adhesion\*.

Hydrocarbon “dirt” to be removed	Concentration SDS in water (%)	$\gamma_{D/W}$ (mN/m)	$\gamma_{S/W}$ (mN/m)	$\gamma_{S/D}$ (mN/m)	$W_{S/D}$ (erg/cm <sup>2</sup> )	Removal or non-removal after submersion
1-Hexanol	0	7.1	50.5	2.4	55.2	No removal
	0.05	5.5	28.1	2.4	31.2	No removal
	0.1	4.0	17.4	2.4	19.0	Removal
	0.25	3.0	13.0	2.4	13.6	Removal
1-Hexanoic acid	0	6.6	50.5	1.8	55.3	No removal
	0.05	3.3	22.1	1.8	29.6	No removal
	0.1	2.7	17.4	1.8	18.3	Removal
	0.25	1.4	13.0	1.8	12.6	Removal

\* Removal based on rolling-up and detachment of oil drops on a flat surface of solid paraffin after gentle submersion in washing liquid. From data in Ref. [902].

In terms of components, the popularity of “natural” cosmetics stems from consumer perceptions of better purity, safety and efficacy. Although many products have the label “natural” or “herbal,” some of these merely contain herbal extracts that have been added for marketing value. Formulating a shampoo generally meets the following criteria: mild detergency, good foaming, good conditioning, adequately preserved and aesthetically appealing [903]. Although there are no standards for a “natural” shampoo, it may incorporate the following, no hazardous chemicals, use of plant or plant-based surfactants, and only natural additives (e.g., a viscosity builder such as xanthan gum) and preservatives (e.g., an antimicrobial such as alkyl-polyglucosides) [903]. The meaning of the phrase “natural surfactant” is sometimes stretched to mean not just a surfactant taken directly from a natural source, but one that was derived from a natural source via chemical reaction(s).

Synthetic surfactants are commonly used in shampoos, sometimes for reasons of cost and sometimes for performance. Non-ideal mixing in micelles can result when the repulsions between different surfactant head-groups are not uniform, such as when an anionic sulfonate is mixed with a non-ionic ethoxylate or when an anionic is mixed with a betaine. This causes the cmc of the mixture to be smaller than would be the case for ideal mixing, or for either surfactant alone. Such a reduction in cmc can be used to reduce the surfactant monomer concentration in a shampoo. This is an advantage since reducing the monomer concentration reduces the amount of eye and skin irritation experienced when the shampoo is used [904]. Other synthetics offer other benefits. For example, some silicone surfactants can not only function as emulsifiers in hair and skin care products, but also act to improve feel, gloss, sheen, emolliency, conditioning and foam stabilization [905].

### 15.3

#### **Cosmetic Skin Care Products**

Cosmetic skin care products have both functional and aesthetic requirements, and contain many ingredients whose interactions with each other are not always well understood [906]. These products are frequently formulated as emulsions, which can provide an “otherwise impractical combination of ingredients into a single formulation and enable regulation of rheological properties without significantly affecting the efficacy of active ingredients” [907]. This kind of product may be required to serve many functions, including [907]:

- primary functions such as moisturizing and blocking harmful UV radiation;
- secondary functions such as smoothness, velvety feel, pleasant smell and appearance;
- being physically, chemically, and microbiologically stable; and
- being non-sensitizing and non-irritating.

Formulating creams as emulsions, especially O/W emulsions, promotes easy spreading and adsorption, while allowing both water and oil-soluble components to

be contained in a single product. The aqueous phase (typically 60–80 volume%) contains such components as [907]:

- humectants to prevent water loss, (e.g., glycerin, sorbitol, propylene glycol);
- co-solvents to solubilize fragrances or preservatives;
- chelating agents to bind polyvalent ions and preserve emulsion stability (e.g., EDTA);
- water soluble (e.g., ionic) surfactants to stabilize the emulsions;
- quaternary ammonium surfactants (quats) to provide germicidal activity (e.g., N-alkyldimethylbenzylammonium chloride);
- viscosity builders (e.g., gums, cellulose, clay minerals);
- proteins, water-soluble vitamins and minerals.

Lotions and creams usually contain emollients, oils that provide a smooth lubricant effect when applied to the skin. The oleic phase (typically 20–40 volume% of the overall emulsion) contains such components as [907]:

- oils and waxes (e.g., silicone oil, mineral oil, paraffin, petrolatum, or lipids);
- dyes and perfumes;
- oil-soluble surfactants to stabilize the emulsion (e.g., aliphatic alcohols, aliphatic carboxylic acids, aliphatic esters).

Where lipids are used they tend to be triacylglycerols or wax esters [908]. Triacylglycerols are esters of glycerol and carboxylic acids, such as castor oil, or olive oil, among many others. Wax esters are fatty acids that have been esterified to fatty alcohols, such as lanolin or jojoba oil. The lipid oils are quite complex and can each contain hundreds of fatty acid esters and/or alcohols. Their W/O emulsions can be complicated to stabilize, due to the possibility of the triglycerides forming solid crystals. As with other personal care products, many consumers prefer products made with “natural” ingredients. In the case of cosmetics this is partly because good skin health is often associated with natural ingredients. For this reason, essential oils, volatile aromatic liquids extracted from plant parts such as flowers, are often added as antimicrobial preservatives [909].

Cosmetic creams and lotions may be formulated with ingredient designed to penetrate the outer layer of the skin (the stratum corneum), or explicitly not to enter this layer. Liposomes can be a useful means of delivering selected chemical species since they form lamellar liquid crystalline structures on the surface of skin, do not disrupt the outermost layer of skin and therefore do not cause skin irritation [236]. See also Section 14.2 on vesicles and drug delivery.

Although forming a protective barrier on the skin is important, some cosmetic products also contain physiologically active ingredients that will improve skin conditions only if they penetrate the skin [431]. The active substance(s) can be encapsulated in the internal aqueous phase or the internal oleic phase depending on the type of emulsion and whether the active ingredient is lipophilic or hydrophilic. If the protective film is not to be broken then the active substance has to diffuse across the oleic layer that has been deposited on the skin surface [910]. This diffusion will be approximately described by Fick’s law (Section 5.5), but is complicated by the fact

that the composition of the cosmetic formulation changes during the course of the application (as volatile components including water vaporize). Having the product formulated as an emulsion has additional benefits when it comes to the delivery of active ingredients which, for example, are released more slowly from multiple emulsions than from pure solutions containing the same substances [910].

The nature of a cosmetic emulsion may be W/O, O/W, multiple, nanoemulsion [911], or microemulsion. Water external emulsions tend to be used where the volume fraction of oil does not need to be too high and the product should not feel too greasy, such as in a hand cream. Oil external emulsions tend to be used where large amounts of oil are desired, a more greasy feel is desired or acceptable, and a longer-lasting residue is required, such as in emollient and cleansing creams. When the creams contain therapeutic ingredients then the nature of the emulsion influences the rate of release, and therefore the rate of action. For example, W/O emulsions containing an antiseptic provide a mild and prolonged action compared with an O/W formulation, which causes a faster action. Table 15.3 provides illustrative formulations for two creams: an O/W “night cream” and a W/O “baby cream”.

**Table 15.3** Illustration of two personal care cream product formulations.

Product type	Ingredient	Concentration (%)	Function
Night cream (O/W)			
	Orange roughy oil	8	Conditioner
	Dimethicone silicone fluid (200–300cS)	1	
	Cetyl acetate/acetylated lanolin alcohol	1	Emollient
	Myristyl myristate	3	Emulsifier
	PEG-24 stearate	3	Emulsifier
	Cetearyl alcohol	2	Emulsifier
	Glyceryl stearate	7	Emulsifier
	Propylene glycol	3	
	Soluble collagen in water (0.3%)	11	Moisturizer
	Water	to 100	
	Perfume, preservative	qs*	
Baby cream (W/O)			
	Lanolin alcohols	2	Emulsifier
	Lanolin	4.5	Emollient/ moisturizer
	Mineral oil (70 cS)	17	
	White petroleum jelly	13.3	
	Butylated hydroxytoluene (BHT)	0.01	Antioxidant
	Glycerine	5	Emollient
	Water	to 100	
	Zinc oxide	7	Sunscreen
	Perfume, preservative, colour	qs	

\* qs = *quantum sufficit* (as much as will suffice to produce the desired effect).

Adapted from Ref. [908].

With so many different emulsion types being used, the preparation processes can vary considerably. Cold (cleansing) creams are W/O/W emulsions. To prepare such a W/O/W multiple emulsion one usually first makes a fairly stable W/O emulsion using, for example, a low-HLB surfactant dissolved in the oil phase. This emulsion is then itself dispersed, under moderate shear, into an aqueous phase containing a high-HLB surfactant [440,912]. Section 7.1.1 discusses in more detail the preparation of such multiple emulsions. W/O/W emulsions provide a way to formulate creams and lotions with the viscosity and “feel” of an external water phase while providing flexibility in setting the internal oil/water ratio [429]. They also permit the formulation of two incompatible hydrophilic materials in the same emulsion by placing one in the internal aqueous phase and the other in the external aqueous phase [429]. In addition, multiple emulsions tend to provide more prolonged release of dermatologically-active agents than when single emulsions are used [440].

Water-external microemulsions have been used in some creams and lotions [234]. These have the advantage of being able to accommodate significant volume fractions of the dispersed phase, from 20–40%, without significantly increasing the viscosity [429]. Microemulsions have not, however, been used much for cosmetic skin care products because high concentrations of surfactant are needed, which increases both the cost and the risk of the product, causing skin irritation [913]. Selection of the actual emulsifier(s) for cosmetic skin care products is usually based on HLB while being careful about their possible toxicity and/or irritability. One means of minimizing toxicity concerns is to use large molecules that will not penetrate the outermost layers of skin (stratum corneum) [427]. Some emulsifiers can cause irritation by interacting with proteins and causing swelling of the outer layer of the skin. Non-ionic surfactants may be used instead of ionic surfactants, since the former either do not bind to proteins or bind weakly at most [914]. Cationic surfactants have been suggested for their ability to improve the sensory feel of skin care creams and lotions [915].

Cosmetic formulations are dependent on new formulation techniques for emulsions, particularly for storage properties [916]. The phase inversion temperature (PIT, see Section 3.6.1) emulsions and microemulsions are characterized by fine droplet sizes which are highly stable. Microemulsions are useful for creating a transparent formulation of oil in water, and in some cases can actually create a less irritating product [917]. In a PIT system, the water/oil emulsion is cooled below the inversion range temperature, yielding an oil/water emulsion which generally has droplet sizes less than 200 nm, resulting in high kinetic stability. These are sometimes called “blue emulsions” because of their blue glimmer. This formulation technique has found use in deodorant emulsion preparation [916]. Microemulsions may also be formed directly, but they are only stable over a limited temperature range. Stabilizers in the form of new surfactants (e.g., alkyl polyglycosides) may extend the stability range over increased temperature ranges. Stability is also dependent on HLB, so a precise co-emulsifier concentration must be selected [916]. Good cosmetic formulations also yield good skin–product interactions and therefore good penetration of active ingredients into the skin layers. A hand cream, for instance, may be an O/W macroemulsion with a 10–25% oil phase, or a W/O emulsion, which has a greasier

feel and leaves a longer-lasting residue [917]. The emulsifier chosen in each formulation is usually determined by its HLB or PIT. Phase behaviour, as the product dries on the skin, is an important factor in producing an effective product [916].

The rheological properties of cosmetic creams and lotions are an important aspect of both product appearance and consumer approval. As soon as a lotion or cream is picked up and moved a certain shear rate has been applied to it; another is applied when the product is dispensed. When these things happen the product must not run but should spread easily and retain an appropriate appearance [215,429]. Cosmetic emulsions that are intended for moisturizing, cleansing, and protecting skin require rheological properties that permit rapid application and the deposition of continuous, protective oleic films onto skin surfaces [427]. The rheological properties also determine the final thickness of the oleic layers that are deposited onto the skin surface, which in turn determines the effectiveness of the product, since skin moisturizing occurs by the formation of an occlusive film over the skin surface, which slows down moisture loss [427,907]. Cosmetic creams and lotions are generally non-Newtonian fluids, exhibiting shear thinning behaviour and a yield stress [215,429]. The thixotropy allows a cream to be highly viscous when at rest, to exhibit low viscosity when being applied, i.e., under shear, but subsequently to acquire a gradual recovery (increase) in the viscosity. The shear rate used when applying creams or lotions is typically  $10^3$ – $10^4$   $s^{-1}$  [918] (see Table 6.2 for some other shear rate regimes). Finally, cosmetic emulsions may be prepared as viscoelastic gels through the incorporation of hydrocolloid and other polymer thickeners, such as sodium alginate, sodium carboxymethyl cellulose, and methyl cellulose.

Ointments are similar to creams but may be more viscous. Many ointments are prepared from a base of anhydrous lanolin or white petrolatum, which is a mixture of *n*-, iso-, and cyclic-paraffins. Waxes may be added to make the ointments harder.

Lotions are less viscous than creams but still need to be sufficiently viscous to enhance suspension stability. Lotions also experience from low to high shear rates: approximately  $10$ – $90$   $s^{-1}$  when being poured from a bottle, about  $125$   $s^{-1}$  when being gently smeared on with fingers, and thousands of  $s^{-1}$  when being rubbed into the skin. Typical lotion bases include suspensions of cetostearyl alcohol or stearic acid particles.

Stability is important for cosmetic skin care products from the points of view of function and also shelf-life. Stability against aggregation is important but fairly easily dealt with because most of these products are formulated to have a yield stress. Stability against coalescence is very important but less straightforward (see Chapter 5 for the factors involved). In the cosmetics industry standardized tests have been developed to yield the net effect of all aspects of emulsion stability. Since most cosmetic products require a useful life of 2–5 years, stability tests that accelerate aging allow estimates to be made of the products' long-term stability. Such tests include, for example, centrifugation and vibrational testing, and may include comparisons with an established product of known stability [440,919].



## 15.4

**Other Personal Care Products**

A number of personal care foams are produced from what are commonly known as aerosol products, which traditionally contain gas mixed with a liquid under very high pressure<sup>1)</sup>. These include cosmetic foams like hair-styling mousse, shaving foam, and even shampoos. There are also some similar non-personal care products such as aerosol foods (i.e., canned whipped cream), household aerosol foams (like glass and carpet cleaning foams), and household insulating foams (polyurethane foam). Originally these tended to use chlorofluorocarbons (CFCs) as the pressurized propellant phase (which in application becomes the dispersed gas phase). With increasing environmental awareness and concerns, formulation practices have changed in response to regulations limiting the use of volatile organic compounds (VOCs). The CFCs have largely been replaced by propane–butane blends, and now volatile methylsiloxanes are being substituted for hydrocarbon-based solvents in general. These products are formulated as emulsions in the pressurized containers and therefore contain a number of components that are needed, among other things, to stabilize the emulsion in the can, and then to stabilize the foam that is produced during the use of the aerosol product [920]. When these products are released from the pressurized containers, foam is generated by the very high shear rates experienced during extrusion through the container valve, on the order of 1000 to 10 000 s<sup>-1</sup> [215]. Table 15.4 provides illustrations of generic hair styling mousse and shaving foam formulations.

Lipstick and lip balms are usually concentrated suspensions of solid oils in a liquid oil, or in a mixture of liquid oils. The dispersed phase, about 60 mass%, comprises oils and/or wax that are solid at room temperature. The continuous phase, about 40 mass%, comprises an oil, or mixture of oils, that is liquid at room temperature. These products are formulated at relatively high temperature, where they are liquid, and are then cooled to allow a significant yield stress to develop. Lipsticks and lip balms contain a variety of waxes, oils, pigments, and emollients, including:

- solid waxes, such as beeswax, carnauba wax, or candelilla wax, which give lipstick its shape and ease of application;
- solid oils, such as lanolin, palm oil, mango butter, shea butter, or cocoa butter which give lipstick its tough, shiny film when it dries after application;
- liquid oils, such as castor, olive, sunflower, or almond oil which provide the continuous phase and ensure ease of application;
- other ingredients, such as moisturizers, vitamin E, aloe vera, collagen, amino acids, and sunscreen (to help keep lips soft, moist, and protected from the elements); and

1) This common use of the term aerosol refers to formulated products that are packaged under pressure, and released through a fine orifice to produce a foam. This is different from the meaning of the term aerosol in colloid and

interface science, which refers to a dispersion of either liquid droplets or solid particles in a gas (liquid aerosols or solid aerosols, respectively).

**Table 15.4** Illustration of some personal care “foam aerosol” product formulations

Product type	Ingredient	Concentration (%)	Function
Aerosol hair-styling mousse			
	Polyquats/pseudoquats	5	Conditioner
	PVP/VA copolymer	3–5	Setting agent
	Alcohol	<10	Solvent
	Surfactant	0.6	Emulsifier
	Perfume oil	0.3	Fragrance
	Water	to 100	Solvent
	Propane/butane/isobutane	10	Propellant
Aerosol shaving foam			
	Fatty acid surfactant	5–8	Foam stabilizer
	Glycerine	3–5	Lubricant
	Triethanolamine	2–4	Neutraliser
	Surfactant 2	3	Emulsifier
	Potassium hydroxide	0.5	Neutraliser
	Perfume oil	0.5	Fragrance
	Water	to 100	Solvent
	Propane/butane/isobutane	4	Propellant

Ref.: Adapted from [920].

- pigments, to give lipstick its colour (e.g., soluble dyes such as D&C Red No. 21, and insoluble dyes (known as lakes) such as D&C Red No. 34; pink shades are made by mixing titanium dioxide with various red dyes).

A wide range of product types are produced by varying the relative proportions of wax, oil, and pigment [921,922]. For example, matte lipsticks contain higher proportions of wax and pigment whereas gloss lipsticks contain higher proportions of oil and less wax. Dispersed solids such as titanium dioxide and zinc oxide provide a sunscreen by absorbing or reflecting UV radiation. Dispersing an additional solid phase into lipstick can create a further range of product types, such as frosted lipsticks from bismuth oxychloride (synthetic pearl), or shimmering lipsticks from mica or silica particles. Another example is the inclusion of encapsulated flavours and/or fragrances [923]. Lipsticks have traditionally provided aesthetics with limited skin protection, while lip balms have offered skin protection with limited aesthetics, although these distinctions are now blurring as skin protection in all cosmetic products becomes more important to consumers [924].

There are also personal cleansing products formulated so as to provide certain ingredients that will be left behind on the skin once the cleansing product is washed off. Such (water soluble) ingredients may be formulated into multiple emulsions or liposomes.

Exfoliating scrubs are used to remove dead surface cells and allow other products, such as essential oils, to penetrate the skin more effectively. These are principally suspensions of some kind of particles that are intended to do the exfoliating. Exam-

ples include ground pumice, microbeads, ground nut shells (such as walnut), and ground fruit seeds (such as apricot). Other additives may include oils, salts and scents.

Beyond facial creams, facial masks are usually concentrated particle suspensions, and are used to treat and refresh facial skin. The particles are usually either kaolinite, Fuller's earth, or illite ("green clay") or other clays. The particles are intended to act as exfoliants and also to adsorb oils from the skin. Other additives span a wide range of materials, including essential oils, vitamins, fruits and vegetables, scents, and pharmaceutical (cosmeceutical) additives, such as salicylic acid when added to treat mild acne. Body clays are like facial masks except that a higher concentration of clay is used in the suspension.

Nail polishes are essentially organic coatings and contain pigment, binder, and solvent like other coatings (see Section 12.6). Although nail polishes with volatile organic solvent bases are perhaps the most familiar, aqueous-based nail polishes have also been formulated [925]. After application, when the water evaporates from an aqueous-based polish, the dispersed polymer has to coalesce to form the final coating. To achieve this and still end up with a strong coating, coalescing aids such as glycol ethers are added. These reduce the glass transition temperature of the polymer to aid in polymer coalescence, then they evaporate slowly, essentially with the water, so that as the polish dries the glass transition temperature increases, leaving a hard, durable coating [925]. Some nail polishes comprise a suspension in volatile solvent of pigment particles, and/or "glitter" components such as micas and pearls. Despite the need for volatile solvent, nail polish needs to be viscous enough to provide good adherence to the applying brush but shear-thin rapidly when applied in order to provide an even coating, without brush marks, on the nails [429].

## 16

### Emerging Areas in Emulsions, Foams and Suspensions

Much is known about colloids, their formation, properties and applications, but considerably more surely remains unknown. There continue to be new colloidal dispersion application developments in the industrial and health areas, as described in some of the preceding chapters.

In particular, the full potential to control colloids is not presently realized. There are several types of complex, mixed colloid that are only poorly understood. For example, the properties of colloids in which more than one type of colloidal species is dispersed may be dominated by the behaviour of the minor dispersed-phase component. The nature and properties of colloids within colloids, such as suspended solids in the dispersed phase of an emulsion, or emulsified oil within the aqueous lamellae of a foam, are only beginning to be understood [2–4].

There are also some new trends emerging in areas that might not have been fully appreciated as recently as ten years ago. Three examples are smart colloids, nanodispersions, and the need to combat agents of terror.

#### 16.1

##### Smart Colloids

Smart colloids, or more generally smart materials, are those that are able to respond in desirable ways to changes in physical conditions, such as temperature, illumination, solution properties, or an applied magnetic or electric field [926]. Although some smart colloids are not new (electro-rheological and magneto-rheological colloids were each discovered in the 1940s), new applications and new kinds of smart colloids are now emerging.

Magneto-rheological (MR) materials are dispersions whose viscosity can change by orders of magnitude when exposed to a magnetic field. Such dispersions can quickly (in about a millisecond) change from fluid to solid. Examples include suspensions of iron or iron-containing particles in oil (also termed ferrofluids [927–929]). Without an applied field, the magnetic moments of the dispersed particles are randomly oriented. However, when a sufficiently large external magnetic field is applied the particles will align with the field and form chains and structures. MR materials have been used in hydraulic speakers, vibration dampers, and shock

absorbers [930]. A related and emerging smart colloid area is the development of magnetic polymer materials [931].

Similarly, electro-rheological (ER) materials are dispersions whose viscosity can change by orders of magnitude when exposed to an electric field, including transitioning from fluid to solid [932]. The application of the electric field creates induced dipoles in the particles, causing the particles to form chains and structures. Examples include suspensions of charged polymer particles in a silicone oil and deformable polymer gels [933]. In both cases the transitions are reversible, their viscosities return to low levels when the external field is removed. ER materials have been used in electronically controlled mechanical clutch applications [930]. A related area is the field of electroactive solids in which, for example, some “smart” electroactive polymer materials will deflect when a current is passed through them, thus converting electrical energy into mechanical energy, and vice versa (e.g., [934–937]).

Other smart materials include gels that can respond to changes in conditions other than electric and magnetic fields, such as pH, temperature, or solvent composition. An example is in the terpolymer gels of vinyl monomers [938]. Another example of a recently developed kind of smart colloid involves dispersed colloidal microgel particles. Poly(*N*-isopropylacrylamide) microgels exhibit a thermoreversible conformational transition in water at around 34 °C [926]. Below this temperature the microgel is highly swollen with water due to strong polymer–water interactions. Above this temperature polymer–polymer interactions become more important than the polymer–water interactions and the particles contract, causing the microgel to shrink and expel water. The collapsed microgel particles remain dispersed due to electrostatic stabilization. These changes are reversible, and can be quite rapid, taking only a few seconds [926]. In comparison, the time required for a conventional solution of polymer molecules is in the range of hours to days. This kind of smart colloid is also referred to as a “thermo-shrinking polymer” (see Refs. [939–941]).

Some applications of microgel smart colloids include drug-delivery vehicles, with the possibility of being turned on or off by swelling or shrinking in response to the presence or absence of specific substances such as glucose [942,943] or antigens [944,945]. Other potential application areas include binding/adsorption agents, catalytic media, and their ability to improve existing industrial formulations such as coatings and cosmetics [926,946–949].

## 16.2

### **Nanodispersions**

Nanotechnology involves the production of materials and structures in the 0.1–100 nm range by any of a variety of nanoscale physical and chemical methods. This is a rapidly growing area of materials science [950]. As the size range indicates, there is an overlap between nanotechnology and colloid science since they share some similarity of scale, both dealing with matter having dimensions of tens and hundreds of nm. Although some nanodispersions are simply colloidal dispersions under a new name, some aspects of nanotechnology are genuinely new, and with unusual proper-

ties, such as carbon nanotubes and quantum dots. Nanotechnology also encompasses the “nano approach”, by which is meant the precise, controlled assembly of structures down to the molecular scale that are well-organized, in contrast with the formation of materials by subdividing bulk phases and then kinetically stabilizing their dispersions using emulsifiers and stabilizers [951].

Although many areas of nanotechnology do not directly deal with colloidal dispersions (such as nanoelectronic devices [952]) other areas do, such as the use of colloidal ink dispersions in robocasting to build near-nanometre scale three-dimensional structures. The possible use of nanoemulsions for intravenous delivery and in medical diagnostics has already been mentioned in Sections 14.4 and 14.5. Some other application areas include:

- nanosized clay particles as additives to promote flame retardancy;
- nanosized pigments in paints and other coatings;
- nanocomposites for automotive and aircraft parts [953];
- nanoceramic coatings;
- nanowires, nanobelts, nanoribbons and nanorods in nanoscale electronic circuit elements [952];
- photo-oxidizing nanoparticles incorporated into “self-cleaning” clothing.

Due to their extremely small size and correspondingly large surface areas, nanoparticle suspensions have potential applications in such areas as:

- high surface area catalysis;
- nanosized hollow-sphere powders for use as fillers in paints [954];
- other coatings;
- ceramics; and
- high-density recording materials.

W/O microemulsions have been used in the preparation of nanoparticles and for carrying out other reactions in highly confined geometries [234]. As mentioned in Section 14.3 both nanoparticle suspensions and nanoemulsions have developed for use as drug-delivery agents.

Notwithstanding the excitement being generated by the various kinds of nanomaterials now being created, these developments are creating some safety concerns as well. There is some concern that nanoparticle titanium dioxide, such as may be used in sunscreens, might damage human DNA [923]. For nanoparticles in general, their small size may allow them to cross natural barriers and gain entry to human cells and to the brain. Although the potential for nanoemulsions and nanosuspensions to advance medical diagnostics and drug treatments has been mentioned in Sections 14.3 and 14.4, the full biological effects are largely unknown at present. The same features that permit these nanodispersions to potentially cross the endothelial cells that protect the brain could lead to unwanted side-effects in the body’s most critical areas.

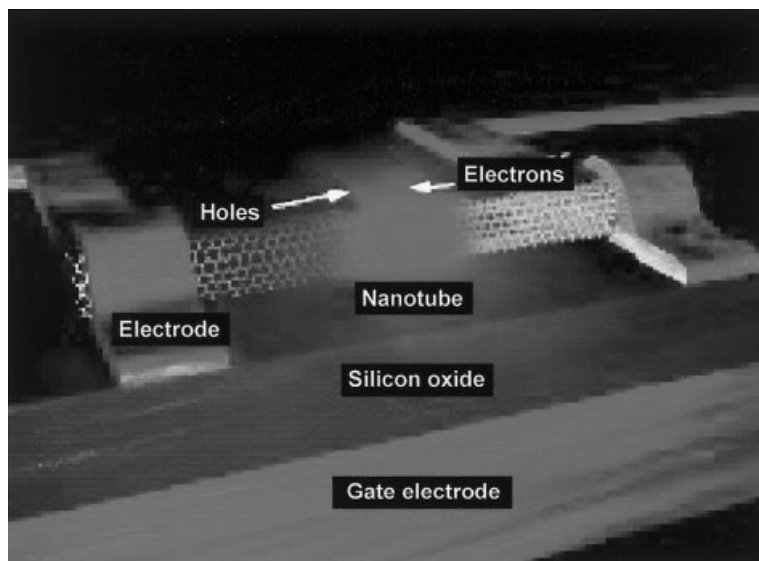
Nanosheets as thin as a few atoms have been prepared from pyrolytic graphite. These graphene sheets are typically made up of hexagonally oriented carbon atoms, are a few nm in thickness, and have been prepared in diameters of 10s–100s of  $\mu\text{m}$

[955]. Although intended for use in semiconductors, such thin sheets may find other applications as well.

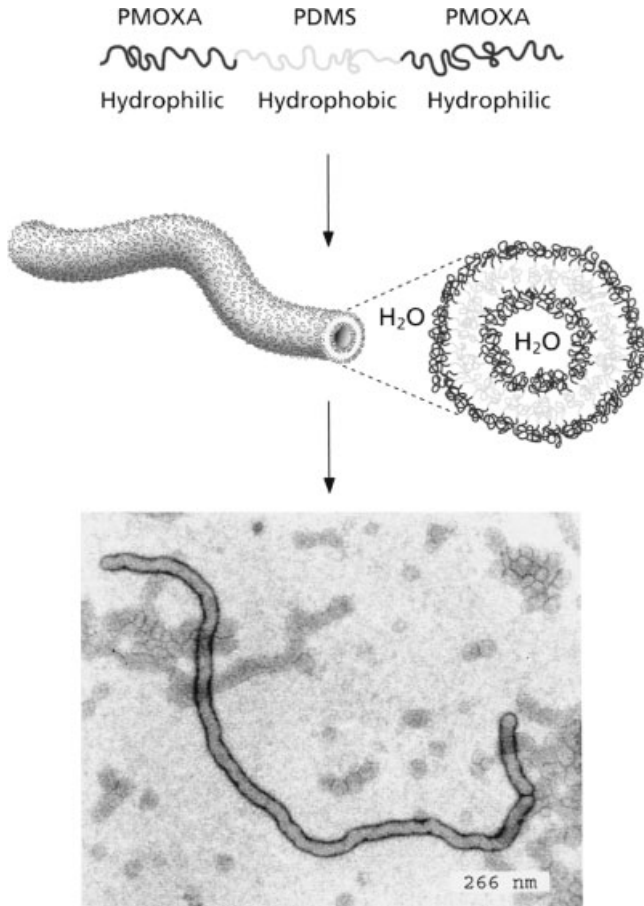
Nanowires and nanotubes are being made into semiconductors and integrated circuits. This in turn is leading in the direction of further miniaturization of electronic devices. An example of current work is the construction of silicon nanowires which are then coated to produce wires or semiconducting wires, having diameters of about 10 nm [956,957]. Titanium dioxide has also been made into nanowires, nanofibres, and nanotubes having dimensions of 5–10 nm thick by 10s–100s of nm in length [958]. These compare with conventional titanium oxide microwires of greater than 50 nm in diameter.

Semiconducting nanowires have been made from conventional semiconducting materials, such as gallium arsenide and also from less conventional materials [959]. For example, nanotubes are of the order of 10 nm in diameter and can be many  $\mu\text{m}$  in length. Carbon nanotube field-effect transistors have been made into tiny light sources by simultaneously injecting positive and negative charge carriers (holes and electrons) from opposite ends (Figure 16.1) [960]. When the holes and electrons combine, infrared light is emitted. It is expected that adjusting the diameter of the nanotubes should permit control of the wavelength of the optical emission [960]. The lengths for which individual nanotubes can be made is increasing. At the time of writing this book, some individual, single-walled carbon nanotubes have been made to lengths as great as 4 cm [961].

Nanotubes can be filled with other chemical species, including water molecules. This has been achieved using ABA triblock copolymers to create soft-walled polymer



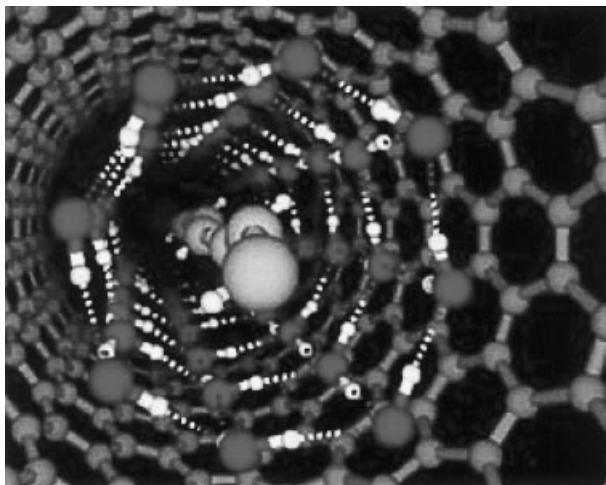
**Figure 16.1** Illustration of a nanotube light-emitting semiconductor. Based on the work of Misewich et al. [960]. From Chemical & Engineering News, copyright 2003 American Chemical Society.



**Figure 16.2** Illustration of an ABA triblock copolymer, a water-containing nanotube made from this copolymer, and a TEM image of the polymer nanotube. From Grumelard [962]. Copyright 2004, Royal Society of Chemistry.

nanotubes of about 50 nm diameter that have hydrophilic inner and outer surfaces (Figure 16.2) [962]. In another approach, carbon nanotubes of about 2 nm diameter have been filled with water molecules, in this case with the water molecules arranged in essentially only one dimension (Figure 16.3) [963]. In both cases the nanotubes had lengths on the order of 10s of micrometres. Such tubes are expected to be useful as model systems for the study of protein channel transport phenomena, and may find application in the controlled release of chemical substances. Nanotubes have been used as nano test tubes, to provide highly confining reaction vessels, such as in the use of single-walled carbon nanotubes in the preparation of linear-(C<sub>60</sub>O)<sub>n</sub> polymers [964]. Under normal (unconstrained) reaction conditions the same synthesis procedure would have produced three-dimensional polymers





**Figure 16.3** Illustration of a water-containing carbon nanotube. From Kolesnikov *et al.* [986]. Copyright 2004, American Physical Society.

[964]. As an example of the range of chemical species that can be inserted into nanotubes, researchers have filled nanotubes with fullerenes [965], which could be a step towards making nanoscale arrays of magnetically active molecules that could be used to create extremely small computing devices.

Nanotubes can also be filled with a variety of molecules to create nanometre-scale filters. These filters can be used to remove bacteria and viruses from water including the poliovirus, which is less than 30 nm in diameter [966,967]. Nanotube filters made from carbon have the disadvantage of being more brittle, but have the advantage of being much more heat-resistant (they can be autoclaved) when compared with conventional polymer or cellulose filters [966]. In addition to water purification, nanotube filters can be used to separate components from mixtures of organic compounds [966].

Finally, examples of work at the interface between solution chemistry and nanodispersions are provided by research aimed at controlling the wettability [968] and the solubility [969] of nanotubes. With such tools available, carefully designed nanotubes may be useful as strength-building additives for new composite materials. Another example is the fabrication of nanoengineered films on colloidal particles [892]. Nanocrystalline titanium dioxide coatings are an example of surface coverings being developed for fabrics, like cotton, to make them essentially self-cleaning by acting as an antibacterial photocatalyst for the decomposition of dirt and harmful micro-organisms [970]. Nanowires, nanofibres, and nanotubes provide potential building blocks for nanostructures of a variety of kinds, and potential substrates for the development of new catalysts. Some other potential application areas for these emerging materials include environmental purification, solar cells, gas sensors, pigments, and cosmetics.

### 16.3

#### Combatting Terror Agents

A wide range of chemical and biological weapons is both available and emerging [971]. New foams are being formulated to provide neutralizing and confining blankets for toxic chemical and biological warfare or terror agents such as anthrax, VX, Soman, mustard gas, and sarin nerve gas. The foams are designed to be dispensed from hand-held pressurized canisters, sprinkler systems, or trucks at the real or potential disaster scene. They are being designed to be non-toxic so that they can be deployed immediately, even before casualties are evacuated (Figure 16.4). These

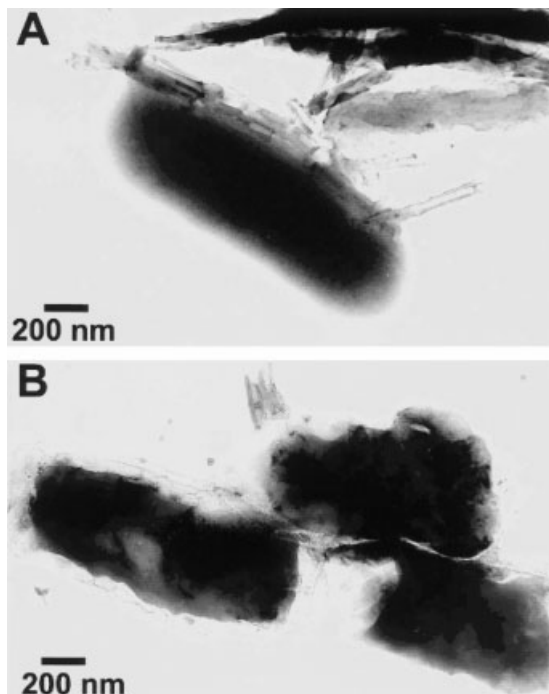


**Figure 16.4** Emergency responder in protective suit applying a decontaminating foam to a surface suspected of carrying a chemical or biological terror/warfare agent. From Sandia [973]. Copyright 1999, Sandia National Laboratories.

highly specialized foams are formulated with detergents and oxidizing agents both to displace and deactivate the toxins [603–605,972–974]. Other decontaminating foams are more sophisticated and more specific, such as foams containing specific enzymes capable of catalyzing the hydrolysis of highly toxic organophosphorus compounds [975].

A possible application for nanotubes (see Section 16.2) is in the sensing and decontamination of chemical and biological weapons. Preliminary results [976] show that some lipid nanotubes change colour when exposed to model chemical weapon components and bacteria, and that they may be able to reduce the concentrations of bacteria. Figure 16.5 shows nanotubes adsorbing onto and even piercing an *Escherichia coli* bacteria cell.

A somewhat different application of foam is in blast and fire suppression during attempts to deactivate, or intentionally destroy, suspected terrorist bombs. When such a device, or even a small explosive device used to destroy the suspected item, explodes, severe damage can be caused by the compression wave emanating from the blast or from the fireball that may follow the blast. In Section 9.6 it was mentioned that foam blankets have been developed for blast noise and pressure wave



**Figure 16.5** Illustration of biocidal nanotubes absorbing onto and penetrating the wall of an *E. coli* cell (A), and completely covering the surfaces of several *E. coli* cells (B). *E. coli* cells were used as model biological weapon agents. The mechanism of deactivation is not yet completely understood. From Lee *et al.*, [976]. Copyright 2004, American Chemical Society.

suppression in order to minimize otherwise dangerous sound and damage impacts of explosions [595–597]. Along the same lines, specialized foam blankets are being developed for terrorist bombs, to absorb the compression wave and also to suppress the fireball [597,974,977]. These foams are somewhat similar to those used in fire-fighting (see Section 12.9). In one method of use the foam is generated inside a special tent that is placed over the suspected device. In this case the foam and the expanding tent act together to contain the blast, while the foam decontaminates the enclosed surfaces by destroying nerve and biological agents [974].



## 17

**Glossary of Emulsion, Foam and Suspension Terminology**

## 17.1

**Introduction**

The wide range of practical and industrial applications of emulsions, foams, and surfactants in particular, has led to the adoption of a wide range of technical terms, some quite specific to particular industries. This chapter provides brief explanations for about 500 significant terms in the science and engineering of industrial emulsions, foams, and suspensions. In addition, cross-references for selected synonyms, abbreviations, and closely-related terms are included.

In order to keep the size of this chapter manageable, terms from fundamental colloid and interface science are generally not included here. Most definitions have been given in earlier chapters, and much more comprehensive sources for these definitions are available elsewhere. A good starting point is the recommendations of the IUPAC Commission on Colloid and Surface Chemistry [978–980]. For more comprehensive dictionaries and glossaries of terms in colloid and interface science, see Refs. [9–11,981–985].

## 17.2

**Terms**

Activator	Any agent that may be used in froth flotation to enhance, selectively, the effectiveness of collectors for certain mineral components. <i>See also</i> Froth Flotation.
Active Surfactant	The primary surfactant in a detergent formulation. <i>See also</i> Detergent.
Aerated Emulsion	A foam in which the liquid consists of two phases in the form of an emulsion. Also termed “foam emulsion”. Example: whipped cream consists of air bubbles dispersed in cream, which is an emulsion. <i>See also</i> Foam.
Aerating Agent	<i>See</i> Foaming Agent.
Aeration	The dispersion and/or dissolution of air into a liquid.

- Aerator** (1) Any machine used for preparing foams, especially in the food industry. In batch aerators, the gas is usually whipped into the liquid. In continuous aerators, a mixing head whips the gas into the liquid under pressure. In this case, the foam expands as it leaves the machine. *See also* Oakes Mixer.
- (2) In environmental applications, any means for increasing the liquid–gas interface to promote either oxygen transfer into water (e.g., to enhance microbial reactions or oxidize compounds) or to enhance the mass transfer of volatile organic materials from the liquid phase to the gas phase.
- Agglomerate Flotation** *See* Oil Assisted Flotation.
- Aging** The properties of many colloidal systems may change with time in storage. Aging in emulsions or foams can refer to any changes of aggregation, coalescence, creaming or chemical. Aged emulsions and foams frequently have larger droplet or bubble sizes. Aging in suspensions usually refers to aggregation, that is, coagulation or flocculation. It is also used to describe the process of recrystallization, in which larger crystals grow at the expense of smaller ones, that is, Ostwald ripening.
- Agitator** A general term referring to mechanical mechanisms that mix and recirculate colloidal dispersions within vessels. The mechanisms may include propellers, paddles, turbines, or shaking devices.
- Agitator Ball Mill** A machine for the comminution, or size reduction, of minerals or other materials. Such machines crush the input material by wet grinding in a cylindrical rotating bin containing grinding balls. These mills can produce colloidal-sized particles.
- Air Drilling Fluid** Air, when used as an oil and gas-well drilling fluid. An air drilling fluid may contain a small amount of water, in which case a more specific term is mist drilling fluid. If the water also contains a foaming agent (surfactant), then the more specific term is foam drilling fluid. Gases other than air are sometimes used, such as nitrogen or natural gas. *See also* Foam Drilling Fluid, Stable Foam, Stiff Foam.
- Airless Spraying** A method for atomizing and spraying a liquid, suspension, or emulsion by high pressure, without using compressed gas at the spray nozzle. Also termed “hydraulic spraying”. Airless spraying is used for paints and urethanes among others.

Alcohol Resisting Aqueous Film Forming Foam	(AFFF-AR) A fire-extinguishing foam formulated specifically for alcohol, polar solvent, and hydrocarbon fires. <i>See also</i> Fluoroprotein Foam, Film Forming Fluoroprotein Foam, Aqueous Film Forming Foam.
Amphoteric Surfactant	A surfactant molecule for which the ionic character of the polar group depends on solution pH. For example, Lauramidopropyl betaine $C_{11}H_{23}CONH(CH_2)_3N^+(CH_3)_2CH_2COO^-$ is positively charged at low pH but is electrically neutral, having both positive and negative charges at intermediate pH. Other combinations are possible, and some amphoteric surfactants are negatively charged at high pH. <i>See also</i> Zwitterionic Surfactant.
Ancillaries	The non-surface active, complementary components in a detergent formulation. <i>See also</i> Detergent.
Anionic Surfactant	A surfactant molecule that can dissociate to yield a surfactant ion whose polar group is negatively charged. Example: sodium dodecyl sulfate, $CH_3(CH_2)_{11}SO_4^-Na^+$ .
Anti-Bubbles	A dispersion of liquid-in-gas-in-liquid in which a droplet of liquid is surrounded by a thin layer of gas that in turn is surrounded by bulk liquid. Example: In an air-aqueous surfactant solution system this dispersion would be designated as water-in-air-in-water, or W/A/W, in fluid film terminology. A liquid-liquid analogy can be drawn with the structures of multiple emulsions. <i>See also</i> Fluid Film.
Antielectrostatic Agent	A surfactant formulation that can be applied to a fabric or fibres to reduce the build-up of static electricity. Examples: alkyl sulfonates and alkyl phosphates.
Antifoaming Agent	Any substance that acts to reduce the stability of a foam; it can also act to prevent foam formation. Terms such as "antifoamer" or "foam inhibitor" specify the prevention of foaming, and terms such as "defoamer" or "foam breaker" specify the reduction or elimination of foam stability. Example: Poly(dimethylsiloxane)s, $(CH_3)_3SiO[(CH_3)_2SiO]_xR$ , where R represents any of a number of organic functional groups. Antifoamers can act by any of a number of mechanisms.
Anti-redeposition Agent	A component in a detergent formulation that acts to help prevent re-deposition of dispersed dirt or grease. Example: carboxymethyl cellulose. <i>See also</i> Detergent.
Antistatic Agent	<i>See</i> Antielectrostatic Agent.
Aphrons	<i>See</i> Microgas Emulsions.
Aqueous Emulsion	An emulsion having an aqueous continuous phase.



Aqueous Film Forming Foam	(AFFF) A fire extinguishing foam based on blended hydrocarbon and fluorocarbon surfactants; a rapidly spreading foam used on hydrocarbon fires. <i>See also</i> Fluoroprotein Foam, Film Forming Fluoroprotein Foam, Alcohol Resisting Aqueous Film Forming Foam.
Atterberg Limits	A group of (originally) seven limits of soil consistency, or relative ease with which material can be deformed or made to flow. The only Atterberg limits that are still in common use are the liquid limit, plastic limit, and plasticity number.
Bancroft's Rule	An empirical generalization that predicts that the continuous phase in an emulsion will be the phase in which the emulsifying agent is most soluble. An extension for solid particles acting as emulsifying agents predicts that the continuous phase will be the phase that preferentially wets the solid particles. <i>See also</i> Hydrophile–Lipophile Balance.
Basic Sediment and Water	That portion of solids and aqueous solution in an emulsion that separates out on standing or is separated by centrifuging in a standardized test method. Basic sediment may contain emulsified oil as well. Also referred to as BS&W, “BSW”, Bottom Settlings and Water, and Bottom Solids and Water.
Batch Mixer	A type of processing equipment in which the entire amount of material to be used is put into the mixer and mixed for a definite period, with multiple recirculation of material through the mixing zone, in contrast to what happens in a continuous mixer. After the mixing period the whole amount of material is removed from the mixer.
Batch Treating	In oil production or processing, the process in which emulsion is collected in a tank and then broken in a batch. This process is used as opposed to continuous or flow-line treating of emulsions.
Beaker Test	<i>See</i> Bottle Test.
Bed Knives	The stationary cutting blades in a cutting mill machine for comminution.
Beneficiation	In mineral processing, any process that results in a product having an improved desired mineral content. Example: froth flotation.

Bi-continuous System	A two-phase system in which both phases are continuous phases. For example, a possible structure for middle-phase microemulsions is one in which both oil and water phases are continuous throughout the microemulsion phase. An analogy can be drawn from the structure of porous and permeable rock in which both the mineral phase and the pore or throat channels can be continuous at the same time. <i>See also</i> Middle-Phase Microemulsion.
Bi-layer	<i>See</i> Bi-molecular Film.
Bi-liquid Foam	A concentrated emulsion of one liquid dispersed in another liquid.
Bi-molecular Film	A membrane that separates two aqueous phases and is composed of two layers of polar organic molecules, such as surfactants or lipids. These molecules are oriented with their hydrocarbon groups in the two molecular layers towards each other and the polar groups facing the respective aqueous phases. <i>See also</i> Vesicle.
Bio-colloidal Dispersion	A colloidal dispersion in which the dispersed phase is of biological origin. Example: a dispersion of lipid particles.
Blender Test	An empirical test in which an amount of potential foaming agent is added into a blender containing a specified volume of liquid to be foamed. After blending at a specified speed and for some specified time, the blending is halted and the extent (volume) of foam produced is measured immediately and after a period of quiescent standing. This test has many variations. <i>See also</i> Bottle Test.
Blowing Agent	A chemical agent in a formulation that provides gas during processing. The gas may result from heating or from a chemical reaction. Example: Water reacts with isocyanate material to produce carbon dioxide gas in one process for making polyurethane (solid) foam.
Bottle Test	Emulsions: An empirical test in which varying amounts of a potential demulsifier or coagulant are added into a series of tubes or bottles containing sub-samples of an emulsion or other dispersion that is to be broken or coagulated. After some specified time, the extent of phase separation and appearance of the interface separating the phases are noted. This test has many variations. For emulsions, in addition to the demulsifier, a diluent can be added to reduce viscosity. In the centrifuge test, centrifugal force can be added to speed up the phase separation. Other synonyms include jar test, beaker test.

	<p>Foams: An empirical test in which an amount of potential foaming agent (or even defoaming agent) is added into a bottle containing a specified volume of liquid to be foamed. The bottle is shaken in a specific manner, for some specified time, after which the shaking is halted and the extent (volume) of foam produced is measured immediately and after a period of time of quiescent standing. This test has many variations. <i>See also</i> Blender Test.</p> <p>Water treatment: A standard test method in which either the coagulant dosage is varied or the solution pH is varied for a given coagulant dosage, to optimize the coagulation of solids. Frequently termed “jar test”. <i>See</i> Basic Sediment and Water.</p>
Bottom Solids and Water Breaking	<p>The process in which an emulsion or foam separates. Usually coalescence causes the separation of a macro-phase, and eventually the formerly dispersed phase becomes a continuous phase, separate from the original continuous phase.</p> <p><i>See</i> Optical Brighteners.</p> <p><i>See</i> Basic Sediment and Water.</p>
Brightening Agents BS&W	
Bubble Point	<p>The gas pressure at which gas bubbles are generated and evolved from a liquid.</p>
Builder	<p>A chemical compound added into detergent formulations to aid oil emulsification (by raising pH and to complex and solubilize hardness ions). Example: sodium tripolyphosphate.</p>
Bulk Foam	<p>Any foam for which the length scale of the confining space is greater than the length scale of the foam bubbles. The converse case categorizes some foams in porous media, distinguished by the term “lamellar foam”. <i>See also</i> Foam, Foam Texture.</p>
Bulking Agent	<p>A material that is added to a formulation that increases the quantity of formulation required for a process without actually changing the formulation’s reactivity. Example: Barium sulfate is sometimes added during processing to increase the density of polyurethane (solid) foam.</p>
Calculation of Phase Inversion in Concentrated Emulsions	<p>(CAPICO) A system in which potential cosmetic emulsion ingredients are numerically categorized so that one may calculate their influence on the phase inversion temperature of a formulated emulsion.</p>
CAPICO	<p><i>See</i> Calculation of Phase Inversion in Concentrated Emulsions.</p>

Cationic Surfactant	A surfactant molecule that can dissociate to yield a surfactant ion whose polar group is positively charged. Example: cetyltrimethylammonium bromide, $\text{CH}_3(\text{CH}_2)_{15}\text{N}^+(\text{CH}_3)_3\text{Br}^-$ .
Cell Membrane	Thin films composed of lipids and proteins that cover the surfaces of cells. Also termed “plasma membranes” or “plasmalemma”.
Centrifugal Separator	<i>See</i> Separator.
Centrifuge Test	<i>See</i> Bottle Test.
Chocolate	A food colloid comprising a suspension of cocoa, sugar and solid milk particles in a continuous fat phase.
Chocolate Mousse Emulsion	A name frequently used to refer to the W/O emulsions of high water content that are formed when crude oils are spilled on the oceans. The name reflects the color and very viscous consistency of these emulsions. It has also been applied to other petroleum emulsions of similar appearance.
Classifier	A machine used to separate particles of specified size ranges. Wet classifiers include settling tanks, centrifuges, hydrocyclones, and vibrating screens. Dry classifiers, also termed “air classifiers”, use gravity or centrifugal settling in gas streams.
Classifier Mill	A kind of mechanical impact mill or jet mill for size reduction (comminution) that also incorporates a particle classifier.
Clays	The term “clay minerals” refers to the aluminosilicate minerals having two or three-layer crystal structure. These minerals typically exhibit high specific surface area, significant surface charge density (cation-exchange capacity), and low hydraulic conductivity. Examples: montmorillonite, kaolinite, illite. The term “clays” is sometimes used to distinguish particles having sizes of less than about 2–4 $\mu\text{m}$ , depending upon the size classification system used. In this sense the term includes any suitably fine-grained solids, including non-clay minerals.
Clotted Soap	<i>See</i> Middle Soap.
Cloud Point	Aqueous Solutions: The transition temperature above which a non-ionic surfactant or wax loses some of its water solubility and becomes ineffective as a surfactant. The originally transparent surfactant solution becomes cloudy because of the separation of a surfactant-rich phase. Cloud points are typically reported on the basis of tests for a specified surfactant concentration such as 1 mass%. <i>See also</i> Coacervation.

	<p>Petroleum Liquids: The temperature at which waxes or other substances begin to separate from solution.</p>
Coacervation	<p>When a lyophilic colloid loses stability, a separation into two liquid phases may occur. This process is termed “coacervation”. The phase that is more concentrated in the colloid is the coacervate, and the other phase is the equilibrium solution. <i>See also</i> Cloud Point.</p>
Coactive Surfactant	<p>The secondary surfactant(s) in a detergent formulation. <i>See also</i> Detergent.</p>
Coalescence	<p>The merging of two or more dispersed species into a single one. Coalescence reduces the total number of dispersed species and also the total interfacial area between phases. In emulsions and foams coalescence can lead to the separation of a macrophase, in which case the emulsion or foam is said to break. The coalescence of solid particles is termed “sintering”.</p>
Collector	<p>A surfactant used in froth flotation to adsorb onto solid particles, make them hydrophobic, and thus facilitate their attachment to gas bubbles. <i>See also</i> Froth Flotation.</p>
Colloid Mill	<p>A high-shear mixing device used to prepare colloidal dispersions of particles or droplets by size reduction (comminution). Also termed “dispersion mill”.</p>
Colloid Stability	<p>In colloid science the term “colloid stability” means that a specified process that causes the colloid to become a macrophase, such as aggregation, does not proceed at a significant rate. Colloid stability is different from thermodynamic stability (<i>see</i> Ref. [978]). The term colloid stability must be used with reference to a specific and clearly defined process, for example, a colloiddally metastable emulsion may signify a system in which the droplets do not participate in aggregation, coalescence, or creaming at a significant rate. <i>See also</i> Kinetic Stability, Thermodynamic Stability.</p>
Colloidal	<p>A state of subdivision in which the particles, droplets, or bubbles dispersed in another phase have at least one dimension between approximately 1 and 1000 nm.</p>
Colloidal Gas Aphrons	<p><i>See</i> Microgas Emulsions.</p>
Colloidal Processing	<p>In ceramics, a variation of slip-casting in which a stabilized colloidal dispersion of particles is poured into a mold for sintering.</p>
Colloidosome	<p>Microcapsules whose shells consist of coagulated or fused colloid particles. Where a liquid is encapsulated within a liquid these bear some relation to Pickering emulsion. An example is given in Ref. [300].</p>
Compaction	<p><i>See</i> Subsidence.</p>

Condensation Methods	The class of methods used for preparing colloidal dispersions in which precipitation from either solution or chemical reaction is used to create colloidal species. The colloidal species are built up by deposition on nuclei that may be of the same or different chemical species. If the nuclei are of the same chemical species, the process is referred to as homogeneous nucleation; if the nuclei are of different chemical species, the process is referred to as heterogeneous nucleation. <i>See also</i> Dispersion Methods.
Consistency	An empirical or qualitative term referring to the relative ease with which a material can be deformed or made to flow. It is a reflection of the cohesive and adhesive forces in a mixture or dispersion. <i>See also</i> Atterberg Limits.
Continuous Phase	In a colloidal dispersion, the phase in which another phase of particles, droplets, or bubbles is dispersed. Sometimes referred to as the external phase. Continuous phase is the opposite of dispersed phase. <i>See also</i> Dispersed Phase.
Co-surfactant	A surfactant that may be added to a system to enhance the effectiveness of another surfactant. The term “co-surfactant” has also been improperly used to describe non-surface-active species that enhance a surfactant’s effectiveness, such as an alcohol or a builder.
Coulter Counter Technique	A particle or droplet-sizing technique in which the flow of dispersed species in a capillary, between charged electrodes, causes changes in conductivity that are interpreted in terms of the sizes of the species. Coulter is the brand name for the automated counter. <i>See also</i> Sensing Zone Technique.
Creaming	The process of emulsion droplets floating upwards under gravity or in a centrifugal field to form a concentrated emulsion (cream) quite distinct from the underlying dilute emulsion. This is not the same as the breaking of an emulsion. <i>See also</i> Sedimentation.
Critical Deposition Velocity	The minimum flow velocity for which dispersed solids flowing in a pipe remain suspended and do not form a bed of particles along the bottom of the pipe. <i>See also</i> Transition Velocity.
Cuff-Layer Emulsion	<i>See</i> Interface Emulsion.
Curd Soap	<i>See</i> Soap Curd.

Cutting Mill	A machine for the comminution, or size reduction, of materials. Such machines use a rotating shaft on which is mounted a series of cutting knives that interleave with a series of separately mounted stationary knives. Cutting mills can reduce materials to particles on the order of 100 $\mu\text{m}$ .
Deaeration	The removal of the gas phase from a dispersion. Example: Some non-aqueous foams (made from bitumen or heavy crude oils) are very viscous and are de-aerated by processes such as contacting with steam in cascading froth, countercurrent steam-flow vessels.
Deaerator	A vessel designed to remove gas (usually air) from a dispersion.
Defoamer	<i>See</i> Foam Breaker, Antifoaming Agent.
Demulsibility	The relative ease with which a particular emulsion may be broken and separated into its constituent liquid phases.
Demulsification	<i>See</i> Demulsifier.
Demulsifier	Chemical: Any agent added to an emulsion that causes or enhances the rate of breaking of the emulsion (separation into its constituent liquid phases). Demulsifiers can act by any of a number of different mechanisms, which usually include enhancing the rate of droplet coalescence. Device: Any device that is used to break emulsions. Such devices may use chemical, electrical, or mechanical means, or a combination, to break an emulsion and cause separation into its constituent liquid phases.
Dense Non-aqueous Phase Liquid	(DNAPL) <i>See</i> Non-aqueous Phase Liquid.
Depletion Flocculation	The flocculation of dispersed species induced by non-adsorbing polymer molecules due to depletion forces. When solutes such as polymer molecules do not, for some reason, enter the gap between adjacent surfaces an attractive force is created between the surfaces. This depletion force arises out of the solute's ability to influence osmotic pressure in bulk but not in the gap between the surfaces.
Deposition Velocity	<i>See</i> Critical Deposition Velocity.
Depressant	Any agent that can be used in froth flotation to selectively reduce the effectiveness of collectors for certain mineral components. <i>See also</i> Froth Flotation.
Desalter	An oil-field or refinery apparatus used to separate water and associated dissolved salts from crude oil.

Detergent	A surfactant that has cleaning properties in dilute solutions. As commercial cleaning products, detergents are actually formulations containing a number of chemical components, including surfactants, builders, bleaches, brighteners, enzymes, opacifiers, and fragrances. In such formulations there is usually a principal surfactant, termed the “main active surfactant”, and a secondary surfactant(s), termed the “coactive surfactant(s)”. The non-surface active components are termed “ancillary components”, or “ancillaries”.
Detergentless Microemulsion	Does not really refer to an emulsion but rather to making an otherwise insoluble component (an oil) soluble by adding a third component.
Detergent Oil	A lubricating oil, formulated to contain surfactant, that has detergent properties in the sense that solid particles are dispersed and kept in suspension. Example: A detergent oil can be used in an internal combustion engine.
Deterision	The action of initiating or causing detergency to happen. <i>See</i> Detergency, Detergent.
De-wetting	In antifoaming, the process by which a droplet or particle of antifoaming agent enters the gas–liquid interface and displaces some of the original liquid from the interface. The liquid is usually an aqueous phase, so the process is sometimes referred to as “de-wetting”.
Discontinuous Phase	<i>See</i> Dispersed Phase.
Disjoining Pressure	The negative derivative with respect to distance of the Gibbs energy of interaction per unit area yields a force per unit area between colloidal species, termed the “disjoining pressure”. Example: In a thin liquid film, the disjoining pressure equals the pressure, beyond the external pressure, that has to be applied to the liquid in the film to maintain a given film thickness.
Disk Attrition Mill	<i>See</i> Disk Mill.
Disk Mill	A machine for the comminution, or size reduction, of wood products or other material. Such machines crush the input material between two grinding plates mounted on rotating disks. Also termed “disk attrition mill”.
Dispersant	Any species that can be used to aid in the formation of a colloidal dispersion. Examples: dispersant for dyestuffs, dispersant for pigments. Often a surfactant, such as a fatty acid derivative.
Disperse Phase	<i>See</i> Dispersed Phase.



Dispersed Phase	In a colloidal dispersion, the phase that is distributed, in the form of particles, droplets, or bubbles, in a second, immiscible phase that is continuous. Also referred to as the disperse, discontinuous, or internal phase. <i>See also</i> Continuous Phase.
Dispersion	Colloids: A system in which finely divided droplets, particles, or bubbles are distributed in another phase. As it is usually used, dispersion implies a distribution without dissolution. An emulsion is an example of a colloidal dispersion; <i>see also</i> Colloidal. Fluid-flow phenomena: The mixing of one fluid in another, immiscible fluid by convection and molecular diffusion during flow through capillary spaces or porous media. Groundwater contamination: The mixing of a contaminant with a non-contaminant phase. The mixing is due to the distribution of flow paths, tortuosity of flow paths, and molecular diffusion.
Dispersion Forces	The London interaction forces between any two bodies of finite mass. A component of the van der Waals forces. The term “dispersion” in dispersion forces comes from an analogy to the refraction (dispersion) of light due to induced dipole interactions. Since London’s induced dipole–induced dipole interactions resemble this, the term “Dispersion Forces” was coined which is unfortunate in that these dispersion forces act against the dispersion of colloidal particles.
Dispersion Medium	The continuous phase in a dispersion.
Dispersion Methods	The class of mechanical methods used for preparing colloidal dispersions in which particles or droplets are progressively subdivided. <i>See also</i> Condensation Methods.
Dispersion Mill	<i>See</i> Colloid Mill.
Dissolved-Gas Flotation	<i>See</i> Froth Flotation.
DNAPL	Dense non-aqueous phase liquid. <i>See</i> Non-aqueous Phase Liquid.
Draves Wetting Test	A method for comparing the wetting power of surfactants. It measures the time required for complete wetting of a piece of cloth or skein of yarn placed at the surface of a surfactant solution, under specified test conditions. Different systems are compared in terms of their wetting times. <i>See also</i> Wetting.

Dynamic Foam Test	Any of several methods for assessing foam stability in which one measures the steady-state foam volume generated under given conditions of gas flow, and shearing or shaking. <i>See also</i> Static Foam Test, Foaminess.
Electrocoagulation	Coagulation induced by exposing a dispersion to an alternating electric field gradient between two sacrificial metal electrodes. Electrocoagulation is apparently due to a combination of the alternating electric field and the adsorption on dispersed particles, or droplets, of ions solubilized from the electrodes.
Electrocratic	A dispersion stabilized principally by electrostatic repulsion.
Electrostatic Treater	A vessel used to break emulsions by promoting coalescence through the application of an electric field. <i>See</i> Treater.
Electrosteric Stabilization	The stabilization of a dispersed species by a combination of electrostatic and steric repulsions. An example is the stabilization of suspended solids by adsorbed polyelectrolyte molecules.
Elutriation	The separation of smaller sized, lighter particles from larger sized, heavier particles due to the flow of surrounding fluid that tends to “carry” the lighter particles.
Embryo	In colloid science, an aggregate of a small number of species. A critical embryo has a size corresponding to maximum Gibbs energy (constant temperature and pressure). A larger embryo is referred to as a “homogeneous nucleus”. <i>See</i> Ref. [978].
Emollient	An agent that lends a soft texture to skin, hair, or membrane tissues. Used in formulated personal care products such as skin creams and hair conditioners.
Emulsator	A device designed to permit observation of the conditions under which emulsion inversion occurs.
Emulsibility	The relative ease with which two immiscible liquids can be made into an emulsion.
Emulsifier	Any agent that acts to stabilize an emulsion. The emulsifier can make it easier to form an emulsion and to provide stability against aggregation and possibly coalescence. Emulsifiers are frequently but not necessarily surfactants.

Emulsion	A dispersion of droplets of one liquid in another, immiscible liquid, in which the droplets are of colloidal or near-colloidal sizes. The term can also refer to colloidal dispersions of liquid crystals in a liquid. Emulsions were previously referred to as emulsoids, meaning emulsion colloids. <i>See also</i> Macroemulsion, Mini-emulsion, Microemulsion.
Emulsion Film	<i>See</i> Liquid Film.
Emulsion Flotation	<i>See</i> Oil Assisted Flotation.
Emulsion Test	In general, emulsion tests range from simple identifications of emulsion presence and volume to detailed component analyses. The term frequently refers simply to the determination of sediments in an emulsion or oil sample. <i>See</i> Basic Sediment and Water.
Emulsion Treater	<i>See</i> Treater.
Emulsoid	An older term meaning “emulsion colloid”. <i>See</i> Emulsion.
Encapsulation	<i>See</i> Microencapsulation.
Engulfment	The process in which a particle dispersed in one phase is overtaken by an advancing interface and surrounded by a second phase. Example: when a freezing front (the interface between a solid and its freezing liquid phase) overtakes a particle, the particle will either be pushed along by the front or else be engulfed by the front, depending on its interfacial tensions with the solid and with the liquid. <i>See also</i> Freezing Front Method.
Enmeshment	<i>See</i> Sweep Flocculation.
Enthalpy/Entropy Stabilization	<i>See</i> Steric Stabilization.
Equivalent Spherical Diameter	The diameter of a sedimenting species determined from Stokes’ law assuming a spherical shape. Also referred to as the “Stokes diameter” or (divided by a factor of 2) the “settling radius”.
Evanescient Foam	A transient foam that has no thin-film persistence and is therefore very unstable. Such foams exist only where new bubbles can be created faster than existing bubbles rupture. Examples: air bubbles blown rapidly into pure water; the foam created when a champagne bottle is opened.
Expansion Factor	In foaming, the ratio of foam volume produced to the volume of liquid used to make the foam. Also termed the “expansion ratio”.
Extender Flotation	<i>See</i> Oil Assisted Flotation.
External Phase	<i>See</i> Continuous Phase.

Fatty Acid Soaps	A class of surfactants comprising the salts of aliphatic carboxylic acids having hydrocarbon chains of between 6 and 20 carbon atoms. Fatty acid soaps are no longer restricted to molecules with origins in natural fats and oils.
Fatty Alcohol Surfactants	The class of primary alcohol surfactants having hydrocarbon chains of between 6 and 20 carbon atoms. Fatty alcohol surfactants are no longer restricted to molecules having their origins in natural fats and oils.
Ferrofluid	A dispersion of finely divided magnetic particles in a liquid, stabilized by electrostatic and/or steric repulsion. Example: $\text{Fe}_3\text{O}_4$ particles in water.
Filler	Fine-grained, inert material that is added to paper, paint, rubber, resin, etc., to improve their properties in some way.
Film Forming Fluoroprotein Foam	(FFFP) A fire-extinguishing foam based on very low-surface-tension producing fluoroprotein surfactants. Used as a rapidly spreading foam on hydrocarbon fires. <i>See also</i> Fluoroprotein Foam, Aqueous Film Forming Foam, Alcohol Resisting Aqueous Film Forming Foam.
Flotation	<i>See</i> Froth Flotation, Sedimentation.
Flow-Line Treating	In oil production or processing, the process in which emulsion is continuously broken and separated into oil and water bulk phases. This process is an alternative to batch treating of emulsions. <i>See also</i> Treater.
Fluid Film	A thin-fluid phase, usually of thickness less than about 1 $\mu\text{m}$ . Such films can be specified by abbreviations similar to those used for emulsions; for example, some common designations are <ul style="list-style-type: none"> <li>– A/W/A for a water film in air,</li> <li>– W/O/W for an oil film in water,</li> <li>– O/W/O for a water film in oil,</li> <li>– W/O/A for an oil film between water and air.</li> </ul> Fluid films are usually unstable to breakage caused by rupture: thinning to the point of allowing contact of the separating phase(s). There can, however, be film thicknesses at which a film is stable or metastable to thickness changes. Films with this property are equilibrium films. Otherwise fluid films can be distinguished by rapid (mobile film) or slow (rigid film) thickness changes.
Fluorescent Whitening Agents	(FWA) <i>See</i> Optical Brighteners.

Fluoroprotein Foam	(FP) A fire-extinguishing foam based on fluouroprotein surfactants. <i>See also</i> Film Forming Fluoroprotein Foam, Aqueous Film Forming Foam, Alcohol Resisting Aqueous Film Forming Foam.
Fly Knives	The rotating cutting blades in a cutting mill machine for comminution.
Foam	A dispersion of gas bubbles in a liquid, in which at least one dimension falls within the colloidal size range. Thus a foam typically contains either very small bubble sizes or, more commonly, quite large gas bubbles separated by thin liquid films. The thin liquid films are called “lamellae” (or “laminae”). Sometimes distinctions are drawn as follows. Concentrated foams, in which liquid films are thinner than the bubble sizes and the gas bubbles are polyhedral, are termed “polyederschaum”. Low-concentration foams, in which the liquid films have thicknesses on the same scale or larger than the bubble sizes and the bubbles are approximately spherical, are termed “gas emulsions”, “gas dispersions”, or “kugelschaum”. <i>See also</i> Evanescent Foam, Froth, Aerated Emulsion.
Foam Booster	<i>See</i> Foaming Agent.
Foam Breaker	Any agent that acts to reduce or eliminate foam stability. Also termed “defoamer”. A more general term is “anti-foaming agent”. <i>See also</i> Antifoaming Agent.
Foam Drainage	The drainage of liquid from liquid lamellae separating bubbles in a foam. <i>See also</i> Fluid Film.
Foam Drilling Fluid	A drilling fluid comprising air, water, and a foaming agent (surfactant). These substances travel into a well as a mist, then change into a foam before returning up the annulus. <i>See also</i> Air Drilling Fluid, Stable Foam, Stiff Foam.
Foam Emulsion	<i>See</i> Aerated Emulsion.
Foam Flooding	Enhanced oil recovery: The process in which a foam is made to flow through an underground reservoir. The foam, which can either be generated on the surface and injected or generated <i>in situ</i> , is used to increase the drive fluid viscosity and improve its sweep efficiency. Petroleum processing: In refinery distillation and fractionation towers, the occurrence of foams, which can carry liquid into regions of the towers intended for vapour.

Foam Fractionation	A separation method in which a component of a liquid preferentially adsorbed at the liquid–gas interface is removed by foaming the liquid and collecting the foam produced. Foaming surfactants can be separated in this manner.
Foaminess	A measure of the persistence of a foam (the time an average bubble exists before bursting). Ideally independent of the apparatus and procedure used, and characteristic of the foaming solution being tested. <i>See also</i> Dynamic Foam Test.
Foaming Agent	Any agent that acts to stabilize a foam. The foaming agent can make it easier to form a foam or provide stability against coalescence. Foaming agents are usually surfactants. Also termed “foam booster”, “whipping agent”, and “aerating agent”.
Foaming Power	<i>See</i> Increase of Volume upon Foaming.
Foam Inhibitor	Any agent that acts to prevent foaming. Also termed “foam preventative”. A more general term is “antifoaming agent”. <i>See also</i> Antifoaming Agent.
Foam Number	A relative drainage rate test in which a foam is formed in a vessel and thereafter the remaining foam volume is determined as a function of time. The foam number is the volume of bulk liquid that has separated after a specified interval, expressed as a percentage of the original volume of liquid foamed.
Foamover	In an industrial process vessel, unwanted foam can occasionally build up to such an extent that it becomes carried out of the top of the vessel (“foamover”) and on to the next part of the process. This carryover of foam and any entrained material that comes with it is frequently detrimental to other parts of a processing operation.
Foam Preventative	<i>See</i> Foam Inhibitor, Antifoaming Agent.
Foam Quality	The gas volume fraction in a foam. Expressed as a percentage this fraction is sometimes referred to as the “Mitchell foam quality”. In three-phase systems, other measures are used. For example, when foams are formulated to contain solid particles as well, the slurry quality, $Q_s$ , which gives the volume fraction of gas plus solid, can be used: $Q_s = (V_g + V_s)/(V_g + V_s + V_l)$ , where $V_g$ , $V_s$ , and $V_l$ denote the volumes of gas, solid, and liquid phases, respectively.
Foam Stability	<i>See</i> Foaminess.

Foam Stimulation Fluid	A foam, aqueous or non-aqueous, that is injected into a petroleum reservoir to improve the productivity of oil- or gas-producing wells. Some mechanisms of action for foam stimulation fluids include fracturing, acidizing to increase permeability, and diversion of flow.
Foam Texture	The bubble size distribution in a foam. For foams in porous media, it can be expressed in terms of the length scale of foam bubbles as compared with that for the spaces confining the foam. When the length scale of the confining space is comparable, to or less than, the length scale of the foam bubbles, the foam is sometimes termed “lamellar foam”, to distinguish it from the opposite case, termed “bulk foam”.
Food Colloid	Many foods are composed of colloiddally dispersed phases. The colloidal properties have a great bearing on their texture, appearance, and stability against separation. Examples: suspensions (chocolate), emulsions (milk), foams (ice-cream), and gels (mayonnaise).
Free Water	The readily separated, non-emulsified water that may be present in an emulsion.
Free Water Knockout	(FWKO) A vessel designed to separate readily separated (non-emulsified or “free”) water from oil or an oil-containing emulsion. Further water and solids removal can be accomplished in a treater.
Froth	A type of foam in which solid particles are also dispersed in the liquid (in addition to the gas bubbles), as in froth flotation. The solid particles can even be the stabilizing agent; alternatively, the foam layer produced at the top of a separation vessel or distillation tower. The term sometimes refers simply to a concentrated foam, but this usage is not preferred.
Frother	<i>See</i> Frothing Agent.
Froth Flotation	A separation process utilizing flotation, in which particulate matter becomes attached to gas (foam) bubbles. The flotation process produces a product layer of concentrated particles in foam, termed froth. Variations include dissolved-gas flotation, in which gas is dissolved in water that is added to a colloidal dispersion. As microbubbles come out of solution they attach to the colloidal species and cause them to float. <i>See also</i> Scavenging Flotation.
Frothing Agent	Any agent that acts to stabilize a froth. Can make it easier to form a froth and provide stability against coalescence. Frothing agents are usually surfactants. Analogous to foaming agent.
FWA	Fluorescent whitening agents. <i>See</i> Optical Brighteners.

FWKO	<i>See</i> Free Water Knockout.
Gas Aphrons	<i>See</i> Microgas Emulsions.
Gas Emulsion	"Wet" foams in which the liquid lamellae have thicknesses on the same scale or larger than the bubble sizes. Typically in these cases the gas bubbles have spherical rather than polyhedral shape. Other synonyms include "gas dispersion" and "kugelschaum". If the bubbles are very small and have a significant lifetime, the term "microfoam" is sometimes used. In petroleum production the term is used to specify crude oil that contains a small volume fraction of dispersed gas. <i>See also</i> Foam.
Gel	A dispersion in the form of a suspension or polymer solution that behaves as an elastic solid or semi-solid rather than a liquid. A dried-out gel is termed a xerogel. Examples: gels of gelatin solutions or of clay suspensions.
Gel Foam	A foam that, in addition to the stabilizing surfactants, contains polymer and a cross-linking agent. The foam is first generated as a polymer-thickened foam, and after a delay period, gels. <i>See also</i> Stiff Foam.
g Forces	<i>See</i> Relative Centrifugal Force.
Glue	<i>See</i> Adhesive, Protein Colloid.
Gold Number	A test used to provide a basis for comparing the stabilizing, or "protecting," ability of polyelectrolytes in suspensions. In this test the "gold number" is defined as the number of milligrams of polyelectrolyte that just prevent the flocculation of 10 ml of a gold sol by 1 ml of a 10% solution of sodium chloride. The smaller the gold number, the greater the protecting, or stabilizing, power of the polyelectrolyte.
Granule/Gravel	Sometimes used to describe particles having sizes greater than about 2000 $\mu\text{m}$ , depending on the classification system used. Also called gravel.
Gravity Separator	<i>See</i> Separator.
Gum	Any hydrophilic plant material, or derivative, that forms a viscous dispersion or solution with water. Example: gum arabic (acacia gum) is derived from Acacia trees and is used in paints, inks, adhesives, and textiles.
Gun Barrel Separator	A type of settling vessel used to separate water and oil from an emulsion. Typically, a heated emulsion is treated with demulsifier and introduced into the gun barrel where water settles out and is drawn off. Any produced gas is also drawn off.



Hammer Mill	A device for reducing the particle size of a solid, (for example, a pigment), that uses centrifugal force to drive the solid between rotating “hammers” and a stationary ring-shaped “anvil”.
Heater Treater	<i>See</i> Treater.
Heterodisperse	A colloidal dispersion in which the sizes of the dispersed species (droplets, particles, etc.) vary. Subcategories are paucidisperse (few sizes) and polydisperse (many sizes). <i>See also</i> Monodisperse, Paucidisperse.
Heterogeneous Nucleation	<i>See</i> Condensation Methods.
High Energy Surface	Qualitative categorization indicating that a surface has a relatively high surface free energy (usually for ionic or covalently bonded materials). Example: sodium chloride crystals, glass. In contrast, low energy surfaces are those having relatively low surface free energies (usually for van der Waals bonded materials). <i>See also</i> Low Energy Surface.
HIOC	<i>See</i> Hydrophobic Ionogenic Organic Compound.
HLB Scale	<i>See</i> Hydrophile–Lipophile Balance.
HLB Temperature	<i>See</i> Phase Inversion Temperature.
HOC	<i>See</i> Hydrophobic Organic Contaminant.
Homogeneous Nucleation	<i>See</i> Condensation Methods.
Homogeneous Nucleation Temperature	The temperature below which the rate of a nucleation process increases rapidly. In practice a narrow range of temperatures represents the transition from very slow to very rapid nucleation. <i>See also</i> Condensation Methods.
Homogeneous Nucleus	<i>See</i> Embryo.
Homogenizer	Any machine for preparing colloidal systems by dispersion. Examples: colloid mill, blender, ultrasonic probe.
Hydraulic Spraying	<i>See</i> Airless Spraying.
Hydrocolloid	Any of the hydrophilic colloidal materials used (mostly) in food products as emulsifying, thickening, and gelling agents. These materials are mostly carbohydrate polymers, although some are proteins. Examples: agar, carrageenan, dextran, gelatin, guar gum.
Hydrophile–Lipophile Balance	(HLB scale) An empirical scale categorizing surfactants in terms of their tendencies to be mostly oil-soluble or water-soluble, hence their tendencies to promote W/O or O/W emulsions, respectively. <i>See also</i> Phase Inversion Temperature.

Hydrophilic	A qualitative term referring to the water-preferring nature of a species (atom, molecule, droplet, particle). For emulsions, “hydrophilic” usually means that a species exhibits an affinity for the aqueous phase over the oil phase. In this example, hydrophilic has the same meaning as oleophobic, but such is not always the case.
Hydrophobic	A qualitative term referring to the water-avoiding nature of a species (atom, molecule, droplet, particle). For emulsions hydrophobic usually means that a species exhibits an affinity for the oil phase over the aqueous phase. In this example, “hydrophobic” has the same meaning as oleophilic, but such is not always the case. A functional group of a molecule that is not very water-soluble is referred to as a “hydrophobe”.
Hydrophobic Ionogenic Organic Compound	(HIOC) An organic compound that is capable of ionizing, depending upon the solution pH. Upon ionization the properties of the molecule change and its sorption and subsurface migration (in the environment) vary accordingly.
Hydrophobic Organic Contaminant	(HOC) An organic molecule (usually neutral) that has a relatively low solubility in water. Example: many pesticides.
Hydrosol	A dispersion of very small diameter species in water or in aqueous solution. Dispersions of finely divided oil droplets in aqueous solution are sometimes referred to as “oil hydrosols”.
Hydrotrope	Any species that enhances the solubility of another. Example: hydrotropes such as alkyl aryl sulfonates (e.g., toluene sulfonate) are added to detergent formulations to raise the cloud point.
Imbibition	The displacement of a non-wetting phase by a wetting phase in a porous medium or a gel; the reverse of drainage.
Immersional Wetting	The process of wetting when a solid (or liquid) that is initially in contact with gas becomes completely covered by an immiscible liquid phase. <i>See also</i> Wetting, Spreading Wetting, Adhesionial Wetting.
Impingement Separator	<i>See</i> Separator.
Inclined Plate Settling	<i>See</i> Lamella Settling.
Increase of Volume upon Foaming	In foaming, the ratio of gas volume to liquid volume in a foam, expressed as a percentage. Also termed the “foaming power”.
Induced Gas Flotation	<i>See</i> Froth Flotation.
Initial Knockdown Capability	<i>See</i> Knockdown Capability.

Integral Capacitance of the Electric Double Layer	<i>See</i> Capacitance of the Electric Double Layer.
Interface Emulsion	An emulsion occurring between oil and water phases in a process separation or treatment apparatus. Such emulsions can have a high solids content and are frequently very viscous. In this case the term “interface” is used in a macroscopic sense and refers to a bulk phase separating two other bulk phases of higher and lower density. Other terms: “cuff layer”, “pad layer”, or “rag layer emulsions”.
Intermicellar Liquid	An older term for the continuous (external) phase in micellar dispersions. <i>See also</i> Continuous Phase, Micelle.
Internal Phase	<i>See</i> Dispersed Phase.
Inverse Micelle	A micelle that is formed in a non-aqueous medium, thus having the surfactants’ hydrophilic groups oriented inward away from the surrounding medium.
Inversion	The process by which one type of emulsion is converted to another, as when an O/W emulsion is transformed into a W/O emulsion, and vice versa. Inversion can be accomplished by a wide variety of physical and chemical means.
Invert Emulsion	A water-in-oil emulsion. This term differs from the term “reverse emulsion”, which is used in the petroleum field.
Invert-Oil Mud	An emulsion drilling fluid (mud) of the water-in-oil (W/O) type, that has a high water content. <i>See also</i> Oil-Base Mud, Oil Mud.
Isodisperse	<i>See</i> Monodisperse.
Jar Test	For emulsions, foams, or water treatment, <i>see</i> Bottle Test.
Jet Impingement	A dispersion technique in which a jet of liquid is directed at a surface or at a jet of another liquid.
Jet Mill	A machine for the comminution, or size reduction, of mineral or other particles. Such machines accelerate feed particles in a jet and cause size reduction by promoting interparticle and particle–wall collisions at high speed. Very small-sized particles can be produced with these mills. Also termed jet pulverizers.
Kinetic Stability	Although most colloidal systems are metastable or unstable with respect to the separate bulk phases, they can have an appreciable kinetic stability. That is, the state of dispersion can exist for an appreciable length of time. Colloidal species can come together in very different ways; therefore, kinetic stability can have different meanings. A colloidal dispersion can be kinetically stable with respect to coalescence but unstable with respect to

	aggregation. Or, a system could be kinetically stable with respect to aggregation but unstable with respect to sedimentation. It is crucial that stability be understood in terms of a clearly defined process. <i>See also</i> Colloid Stability, Thermodynamic Stability.
Knockdown Capability	A measure of the effectiveness of a defoamer. First, a column of foam is generated in a foam stability apparatus and the foam height is recorded. A measured amount of defoamer is added, and the reduction in foam height over a specified time period, for example, 2 s, is noted. The knockdown capability is the reduction in foam height. This test has many variations. Sometimes referred to as “initial knockdown capability”.
Knockout Drops	Demulsifier that can be used to enhance the separation of oil from water and solids, in an emulsion, in the centrifuge test for determining basic sediment and water (BS&W). Also termed “slugging compound”.
Krafft Point	The temperature (in practice a narrow range of temperatures) above which the solubility of a surfactant increases sharply (micelles begin to be formed). Below the Krafft point only single, unassociated surfactant molecules (monomers) or ions (ionomers) can be present, up to a given solubility limit. Above the Krafft point, a solution can contain micelles and thus allow much more surfactant to remain in solution in preference to precipitating. In the soap industry the Krafft point is sometimes defined as the temperature at which a transparent soap solution becomes cloudy upon cooling.
Lamella	<i>See</i> Foam.
Lamellar Foam	Although all foams contain lamellae, this term is sometimes used to distinguish a certain kind of foam in porous media. When the length scale of the confining space is comparable with, or less than, the length scale of the foam bubbles, the foam is termed “lamellar foam” to distinguish from the opposite case, termed “bulk foam”. <i>See also</i> Foam, Foam Texture.
Lamella Settling	A process for phase separation based on density differences. A commercial lamella settler for suspensions or emulsions comprises a stack of parallel plates spaced apart from each other and inclined from the horizontal. The space between each set of plates forms a separate settling zone. The feed is pumped into these spaces, at a point near the longitudinal middle of the plates. The less dense phases rise to the underside of the upper plates

	and flow to the tops of those plates. Meanwhile, the more dense phases settle down to the upperside of the lower plates and flow to the bottoms of those plates. Product is collected at the tops of the plate stack, and tailings are collected at the bottom of the plate stack. Such an inclined lamella-settling process is much more efficient than vertical gravity separation. Also termed “inclined plate settling” or “inclined tube settling”.
Lamina	<i>See</i> Foam.
Laminar Flow	A condition of flow in which all elements of a fluid passing a certain point follow the same path, or streamline; there is no turbulence. Also referred to as “streamline flow”.
Latex	A dispersion (suspension or emulsion) of polymer in water. Latex rubber, a heavily cross-linked polymer solid, is produced either by coagulating natural latex or by synthetic means through emulsion polymerization. Example: Latex paint is a latex containing pigments and filling additives.
Lather	A foam produced by mechanical agitation on a solid surface. Example: the mechanical generation of shaving foam (lather) on a wet bar of soap.
Launderometer	The specialized machine used to perform a standardized test method for measuring the effectiveness of detergents. The degree to which reference soils are washed from standard fabric swatches in the presence of detergents and under specified conditions is determined. <i>See also</i> Detergent, Detergency.
Light Nonaqueous-Phase Liquid	(LNAPL) <i>See</i> Non-aqueous Phase Liquid.
Limiting Sedimentation Coefficient	<i>See</i> Sedimentation Coefficient.
Lipid	Long-chain aliphatic hydrocarbons and derivatives originating in living cells. Some lipids, such as fatty acids, are also surfactants. Simple lipids tend to be hydrocarbon-soluble but not water-soluble. Examples: fatty acids, fats, waxes.
Lipid Film	A thin film of oil in water in which the film is stabilized by lipids. The term is used even though the film is not a film of lipid. <i>See also</i> Fluid Film.
Lipophile	That part of a molecule that is organic-liquid-preferring in nature.
Lipophilic	The (usually fatty) organic-liquid-preferring nature of a species. Depending on the circumstances can also be a synonym for “oleophilic”. <i>See also</i> Hydrophile–Lipophile Balance.

Lipophobe	That part of a molecule that is organic-liquid-avoiding in nature.
Lipophobic	The (usually fatty) organic-liquid-avoiding nature of a species. Depending on the circumstances can also be a synonym for “oleophobic”.
Liposome	<i>See Vesicle.</i>
Liquid Film	Four kinds of thin liquid films are typically distinguished, depending on the nature of the two phases bounding the film: <i>Foam films</i> separating two vapour phases, <i>Emulsion films</i> separating two droplets, <i>Suspension films</i> separating two solid surfaces, and <i>Wetting films</i> separating a solid or liquid from a vapour.
Liquid Limit	The minimum water content for which a small sample of soil or similar material will barely flow in a standardized test method. Also termed the “upper plastic limit”. <i>See also Atterberg Limits, Plastic Limit, Plasticity Number.</i>
LNAPL	Light non-aqueous phase liquid. <i>See Non-aqueous Phase Liquid.</i>
Loose Emulsion	A petroleum industry term for a relatively unstable, easy-to-break emulsion, as opposed to a more stable, difficult-to-treat emulsion. <i>See also Tight Emulsion.</i>
Low Energy Surface	Qualitative categorization indicating that a surface has a relatively low surface free energy (usually for van der Waals bonded materials). Example: paraffin wax. In contrast, high energy surfaces are those having relatively low surface free energies (usually for ionic or covalently bonded materials). <i>See also High Energy Surface.</i>
Lower-Phase Microemulsion	A microemulsion that has a high water content and is stable while in contact with a bulk oil phase, and in laboratory tube or bottle tests tends to be situated at the bottom of the tube, underneath the oil phase. For chlorinated organic liquids, which are denser than water, the oil is at the bottom phase rather than the top. <i>See Microemulsion, Winsor-Type Emulsions.</i>
Lower Plastic Limit	<i>See Plastic Limit.</i>
Lyocratic	A dispersion stabilized principally by solvation forces. Example: the stability of some aqueous biocolloid systems can be explained in terms of hydration and steric stabilization. <i>See also Electrocratic.</i>
Lyophilic	General term referring to the continuous-medium- (or solvent)-preferring nature of a species. <i>See Hydrophilic.</i>
Lyophobic	General term referring to the continuous-medium- (or solvent)-avoiding nature of a species. <i>See Hydrophobic.</i>

Macroemulsion	<i>See</i> Emulsion. In enhanced oil recovery nomenclature, the term “macroemulsion” is employed sometimes to identify emulsions having droplet sizes greater than some specified value and sometimes simply to distinguish an emulsion from the microemulsion or micellar emulsion types.
Main Active	The primary surfactant in a detergent formulation. <i>See also</i> Detergent.
Marine Colloids	Any colloids derived from marine sources. Examples include the hydrophilic colloids (hydrocolloids) derived from various seaweeds, such as algin, and colloids derived from marine animals, such as chitin. <i>See also</i> Seaweed Colloids.
Mechanical Impact Mill	A machine for the comminution, or size reduction, of mineral or other particles. Such machines pulverize feed particles (typically about 10 mm initially) by causing them to strike a surface at high speed. Very small-sized particles can be produced with these mills.
Mechanical Syneresis	Any process in which syneresis is enhanced by mechanical means. <i>See also</i> Syneresis.
Membrane Potential	The potential difference between two identical salt bridges placed into two ionic solutions that are separated from each other by a membrane.
Meniscus	The uppermost surface of a column of a liquid. The meniscus can be either convex or concave depending on the balance of gravitational and surface or interfacial tension forces acting on the liquid.
Metastable	<i>See</i> Thermodynamic Stability.
Micellar Emulsion	An emulsion that forms spontaneously and has extremely small droplet sizes (<10 nm). Such emulsions are thermodynamically stable and are sometimes referred to as “microemulsions”.
Micellar Solubilization	<i>See</i> Solubilization.
Micelle	An aggregate of surfactant molecules or ions in solution. Such aggregates form spontaneously at sufficiently high surfactant concentration, above the critical micelle concentration. The micelles typically contain tens to hundreds of molecules and are of colloidal dimensions. If more than one kind of surfactant forms the micelles, they are referred to as “mixed micelles”. If a micelle becomes larger than usual as a result of either the incorporation of solubilized molecules or the formation of a mixed micelle, then the term “swollen micelle” is applied. <i>See also</i> Inverse Micelle.

Microemulsion	A special kind of stabilized emulsion in which the dispersed droplets are extremely small (<100 nm) and the emulsion is thermodynamically stable. These emulsions are transparent and can form spontaneously. In some usage a lower size-limit of about 10 nm is implied in addition to the upper limit; <i>see also</i> Micellar Emulsion. In some usage the term “microemulsion” is reserved for a Winsor type IV system (water, oil, and surfactants all in a single phase). <i>See also</i> Winsor Type Emulsions.
Microencapsulation	The protection of a chemical species by containing it in small droplets, particles, or bubbles covered by a coating. Example: the encapsulation of liquid within vesicles.
Microfoam	<i>See</i> Gas Emulsion.
Microgas Emulsions	A kind of foam in which the gas bubbles have an unusually thick stabilizing film and exist clustered together as opposed to either separated, nearly spherical bubbles or the more concentrated, system-filling polyhedral bubbles. A microgas emulsion will cream to form a separate phase from water. Also termed “aphrons” or “colloidal gas aphrons”.
Micronizing	The process by which a solid is reduced to particle sizes of less than about 100 $\mu\text{m}$ by using any type of particle-size reduction equipment. Examples: micronized talc, micronized pigment.
Middle-Phase Microemulsion	A microemulsion that has high oil and water content and is stable while in contact with either bulk oil or bulk water phases. This stability can be caused by a bi-continuous structure in which both oil and water phases are simultaneously continuous. In laboratory tube or bottle tests involving samples containing unemulsified oil and water, a middle-phase microemulsion tends to situate between the two phases. <i>See also</i> Winsor Type Emulsions.
Middle Soap	A mesomorphic (liquid-crystal) phase of soap micelles, oriented in a hexagonal array of cylinders. Middle soap contains a similar or lower proportion of soap (e.g., 50%) as opposed to water. Middle soap is in contrast to neat soap, which contains more soap than water and is also a mesomorphic phase, but has a lamellar structure rather than a hexagonal array of cylinders. Also termed “clotted soap”. <i>See</i> Neat Soap.
Mini-emulsion	<i>See</i> Emulsion. The term is sometimes used to distinguish an emulsion from the microemulsion or micellar emulsion types. Thus a mini-emulsion would contain droplet sizes greater than 100 nm and less than 1000 nm, or some other specified upper-size limit.



Mist Drilling Fluid	<i>See</i> Air Drilling Fluid.
Mitchell Foam Quality	<i>See</i> Foam Quality.
Monodisperse	A colloidal dispersion in which all the dispersed species (droplets, particles) have the same size. Otherwise, the system is heterodisperse (paucidisperse or polydisperse).
Motionless Mixer	<i>See</i> Static Mixer.
Mousse Emulsion	<i>See</i> Chocolate Mousse Emulsion.
Multiple Emulsion	An emulsion in which the dispersed droplets themselves contain even more finely dispersed droplets of a separate phase. Thus, there can occur oil-dispersed-in-water-dispersed-in-oil (O/W/O) and water-dispersed-in-oil-dispersed-in-water (W/O/W) multiple emulsions. These emulsions are sometimes called “three-phase emulsions”, “triple-phase emulsions”, or simply “triple emulsions”. More complicated multiple emulsions such as O/W/O/W and W/O/W/O are also possible.
NAPL	<i>See</i> Non-aqueous Phase Liquid.
Nelson-Type Emulsions	Several types of phase behaviour occur in microemulsions; they are denoted as Nelson type II <sup>-</sup> , type II <sup>+</sup> , and type III. These designations refer to equilibrium phase behaviours and distinguish, for example, the number of phases that can be in equilibrium and the nature of the continuous phase. Winsor-type emulsions are similarly identified, but with different type numbers.
Nitrified Foam	A slang term used in some industries to denote foams in which nitrogen is the gas phase.
Non-aqueous Phase Liquid	(NAPL) Any liquid other than water. In environmental fields this term commonly refers to petroleum hydrocarbons less dense than water (light non-aqueous phase liquid, LNAPL), or oils such as chlorinated hydrocarbons that are more dense than water (dense non-aqueous phase liquid, DNAPL).
Non-ionic Surfactant	A surfactant molecule whose polar group is not electrically charged. Example: poly(oxyethylene) alcohol, $C_nH_{2n+1}(OCH_2CH_2)_mOH$ .
Oakes Mixer	A machine used for preparing foams in the food industry. A slurry is continuously stirred and aerated under pressure between a series of blades. <i>See also</i> Aerator.
Octanol–Water Partition Coefficient	The partitioning coefficient of a compound between octanol and water, that is, between specific non-polar and polar phases. Used as an indication of the tendency of a compound to partition between oil and water phases. A variety of empirical equations estimate such partitioning of a compound on the basis of its octanol–water partition coefficient.

Oil	Liquid hydrocarbon. This can include, for example, liquid petroleum (crude oil), synthetic hydrocarbon liquid, bitumen from oil (tar) sands, fractions obtained from crude oil, and liquid fats (e.g., triglycerides).
Oil Assisted Flotation	Any of a family of flotation processes in which oil is used to agglomerate or bridge particles and enhance flotation. In extender flotation, a small amount of oil is added to improve a collector's performance. In agglomerate flotation, oil is added to agglomerate very finely divided particles to a size that can be efficiently floated. In emulsion flotation, oil is added to function as the collector, for already hydrophobic particles.
Oil-Base Mud	An emulsion drilling fluid (mud) of the water-dispersed-in-oil (W/O) type having a low water content. <i>See also</i> Oil Mud, Invert-Oil Mud.
Oil Color	A qualitative test for the presence of emulsified water in an oil. Emulsified water droplets tend to impart a hazy appearance to the oil.
Oil Emulsion	An emulsion having an oil as the continuous phase.
Oil-Emulsion Mud	An emulsion drilling fluid (mud) of the oil-dispersed-in-water (O/W) type. <i>See also</i> Oil Mud.
Oil Hydrosol	An oil-in-water (O/W) emulsion in which the oil droplets are very small and the volume fraction of oil is also very small. The emulsion terminology is preferable. <i>See also</i> Hydrosol.
Oil Mud	An emulsion drilling fluid (mud) of the water-dispersed-in-oil (W/O) type. A mud of low water content is referred to as an "oil-base mud", and a mud of high water content is referred to as an "invert-oil mud". <i>See also</i> Oil-Emulsion Mud.
Oleophilic	The oil-preferring nature of a species. A synonym for lipophilic. <i>See also</i> Hydrophobic.
Oleophobic	The oil-avoiding nature of a species. A synonym for lipophobic. <i>See also</i> Hydrophilic.
O/O	Abbreviation for an oil-dispersed-in-oil emulsion in which one oil is polar and the other is not. Example: an emulsion of ethylene glycol in a liquid alkane.
Opacifiers	Agents that make a liquid appear more opaque, or pearlescent. For example: polystyrene latex is added to liquid detergents formulated for dishwashing or shampooing to give them a flat opaque appearance. <i>See also</i> Detergent.

- Optical Brighteners** Agents that make treated materials appear more white. For example, fluorescent whitening agents are added to laundry detergents so that they can become attached to fibres and give an enhanced whiteness by absorbing UV light and emitting blue light. Example: stilbene disulfonates. *See also* Detergent.
- Optimum Salinity** In microemulsions, the salinity for which the mixing of oil with a surfactant solution produces a middle-phase microemulsion containing an oil-to-water ratio of 1. In micellar enhanced oil recovery processes, extremely low interfacial tensions result, and oil recovery tends to be maximized when this condition is satisfied.
- Oriented-Wedge Theory** An empirical generalization used to predict which phase in an emulsion will be continuous and which dispersed. It is based on a physical picture in which emulsifiers are considered to have a wedge shape and will favour adsorbing at an interface, such that most efficient packing is obtained; that is, with the narrow ends pointed toward the centres of the droplets. A useful starting point, but there are many exceptions. *See also* Bancroft's Rule, Hydrophile–Lipophile Balance.
- Ostwald Ripening** The process by which larger droplets or particles grow in size in preference to smaller droplets or particles because of their different chemical potentials. *See also* Aging.
- O/W** Abbreviation for an oil-dispersed-in-water emulsion.
- O/W/O** In multiple emulsions: abbreviation for an oil-dispersed-in-water-dispersed-in-oil multiple emulsion. The water droplets have oil droplets dispersed within them, and the water droplets themselves are dispersed in oil, forming the continuous phase.  
In fluid films: abbreviation for a thin fluid film of water in an oil phase. Not to be confused with the multiple emulsion convention. *See also* Fluid Film.
- Pad Layer Emulsion** *See* Interface Emulsion.
- Paucidisperse** A colloidal dispersion in which the dispersed species (droplets, particles) have a few different sizes. Paucidisperse is a category of heterodisperse systems. *See also* Monodisperse.
- Peptization** The dispersion of an aggregated (coagulated or flocculated) system. Same meaning as Deflocculation.

Phase Inversion Temperature	(PIT) The temperature at which the hydrophilic and oleophilic natures of a surfactant are in balance. As temperature is increased through the PIT, a surfactant will change from promoting one kind of emulsion, such as O/W, to another, such as W/O. Also termed the “HLB temperature”.
Phase Ratio	In emulsions, the term refers to the ratio between internal phase and continuous phase. Phase ratios are dimensionless, but the units used should be specified because mass ratios and volume ratios are commonly used.
Phospholipid	Esters of phosphoric acid that contain fatty acid(s), an alcohol, and a nitrogen-containing base. <i>See also</i> Lipid.
Phospholipid Bi-layer	<i>See</i> Bi-molecular Film.
Photozone Counter	A particle or droplet-sizing technique, analogous to the electrical sensing-zone methods, that relies on visible light absorption in a sample introduced into a small chamber. The particles or droplets must be greater than the wavelength of the light used, to minimize scattering ( $\geq 1 \mu\text{m}$ ). <i>See</i> Sensing Zone Technique.
Pickering Emulsion	An emulsion stabilized by fine particles. The particles form a close-packed structure at the oil–water interface, with significant mechanical strength, which provides a barrier to coalescence.
Pigment	Insoluble material that is finely divided, micronized (for example), and uniformly dispersed in a formulated system for the purpose of colouring it or making it opaque. Examples: $\text{TiO}_2$ in soap bars and paints; iron oxides in eye make-up and paints.
Pigment Grind	Pigment particles dispersed in a liquid, such as castor oil. <i>See also</i> Roll Mill.
PIT	<i>See</i> Phase Inversion Temperature.
Plasmalemma	<i>See</i> Cell Membrane.
Plasma Membrane	<i>See</i> Cell Membrane.
Plasticity Number	The difference between the liquid limit and the plasticity limit of a soil or similar material. Also termed the “plasticity index”. <i>See also</i> Atterberg Limits, Liquid Limit, Plastic Limit.
Plastic Limit	The minimum water content for which a small sample of soil or similar material will barely deform or crumble in a standardized test method. Also termed the “lower plastic limit”. <i>See also</i> Atterberg Limits, Liquid Limit, Plasticity Number.

Polydisperse	A colloidal dispersion in which the dispersed species (droplets, particles) have a wide range of sizes. Polydisperse is a category of heterodisperse systems. <i>See also</i> Monodisperse.
Polyelectrolyte	A kind of colloidal electrolyte consisting of a macromolecule that, when dissolved, dissociates to yield a polyionic parent macromolecule and its corresponding counterions. Also termed “polyion”, “polycation”, or “polyanion”. Similarly, a polyelectrolyte can be referred to in certain circumstances as a “polyacid”, “polybase”, “polysalt”, or “polyampholyte” (Ref. [978]). Example: carboxymethylcellulose.
Polymer Bridging	A mechanism of aggregation or flocculation in which long-chain polymers adsorb onto particle surfaces leaving loops and ends extending out into solution. If these loops and ends contact and adsorb onto another particle then a so-called bridge is formed. <i>See also</i> Aggregation.
Polymer Charge Patch	A mechanism of aggregation or flocculation in which polymers adsorb onto particles in patches because their charge density is greater than that of the surface, so complete surface coverage is not needed to neutralize the particle charge. Thus regions of positive and negative charge would exist on the particle surfaces, allowing electrostatic attraction between particles to promote aggregation.
Polymer Thickened Foam	A foam that, in addition to the stabilizing surfactants, contains polymer. Polymer thickened foams are formulated to produce increased stability and viscosity. <i>See also</i> Gel Foam, Stiff Foam.
Polysoap	Molecules in which surfactant monomers are incorporated into polymer chains.
Pore	In porous media, the interconnecting channels forming a continuous passage through the medium are made up of pores, or openings, which can be of different sizes. Macropores have diameters greater than about 50 nm. Mesopores have diameters between about 2 and 50 nm. Micropores have diameters of less than about 2 nm.
Porous Medium	A solid containing voids or pore spaces. Normally such pores are quite small compared with the size of the solid and are well-distributed throughout the solid. In geologic formations porosity can be associated with unconsolidated (uncemented) materials, such as sand, or a consolidated material, such as sandstone.
Pour Point	The lowest temperature at which an emulsion, oil, surfactant solution, or other material will flow under a standardized set of test conditions.

Protected Lyophobic Colloids	<i>See</i> Sensitization.
Protection	The process in which a material adsorbs onto droplet surfaces and thereby makes an emulsion less sensitive to aggregation and coalescence by any of a number of mechanisms. <i>See also</i> Sensitization.
Protective Colloid	A colloidal species that adsorbs onto and acts to “protect” the stability of another colloidal system. The term refers specifically to the protecting colloid and only indirectly to the protected colloid. Example: when a lyophilic colloid such as gelatin acts to protect another colloid in a dispersion by conferring steric stabilization. <i>See also</i> Gold Number, Protection.
Protein Colloid	Natural polymers, called “gelatin” or “animal glue”, that are derived from collagen, a major protein in skin, tissues and bone. They are produced by partial hydrolysis of collagen and are amphoteric, containing both amine and acid groups. Gelatin and animal glue represent different degrees of purity; gelatin is more pure. They are examples of hydrophilic colloids.
PSD	Particle size distribution.
Pseudoemulsion Film	A fluid film of an aqueous phase (water) between air and oil phases. These are usually described as O/W/A or A/W/O, in which W represents the thin aqueous film. <i>See also</i> Fluid Film.
Pulp	In mineral processing, a slurry of crushed ore dispersed in water.
Quats	Quaternary ammonium compounds. These compounds are cationic surfactants if they contain a hydrocarbon chain of sufficient length. Example: cetyltrimethylammonium bromide, $\text{CH}_3(\text{CH}_2)_{15}\text{N}^+(\text{CH}_3)_3\text{Br}^-$ . <i>See also</i> Cationic Surfactant.
Raffinate	The phase that remains after specified solute(s) has been removed by extraction. Note that this meaning is distinct from the original meaning of raffinate as a refined product.
Rag Layer Emulsion	<i>See</i> Interface Emulsion.

Relative Centrifugal Force	(RCF) When a centrifuge is used to enhance sedimentation or creaming, the centrifugal force is equal to mass times the square of the angular velocity times the distance of the dispersed species from the axis of rotation. The square of the angular velocity times the distance of the dispersed species from the axis of rotation, when divided by the gravitational constant, $g$ , yields the relative centrifugal force or RCF. RCF is not strictly a force but rather the proportionality constant. It is substituted for $g$ in Stokes' law to yield an expression for centrifuges and is used to compare the relative sedimentation forces achievable in different centrifuges. Because RCF is expressed in multiples of $g$ , it is also termed "g-force" or simply "gs".
Re-peptization	Peptization, usually by dilution, of a once-stable dispersion that was aggregated (coagulated or flocculated) by the addition of electrolyte.
Resistazone Counter Resolution	<i>See</i> Sensing Zone Technique. In emulsion treatment, resolution refers to emulsion breaking and the separation of the oleic and aqueous phases. Example: the breaking and separation of oil-field produced W/O emulsions.
Reverse Emulsion	A petroleum industry term used to denote an oil-in-water emulsion (most well-head emulsions are W/O). Reverse emulsion has the opposite meaning of the term "invert emulsion". <i>See also</i> Invert Emulsion.
Reverse Micelles	Synonym for the dispersed phase in a water-in-oil type microemulsion. Here the surfactant heads, or polar groups, associate closely to minimize interaction with the oil phase. This close association can happen when they orient themselves inside water droplets, and it also allows the surfactant tails, or hydrocarbon groups, to stabilize the water droplets by orienting toward or into the oil.
Reynolds Number	A dimensionless quantity used in the modelling of systems in which viscosity plays a role in determining the velocities, or flow profile, of a fluid. Its value is used to distinguish laminar from turbulent flow regimes.
Rigid Film	<i>See</i> Fluid Film.
Ring Roller Mill	A machine for the comminution, or size reduction, of minerals. Such machines crush the input material between a stationary ring and vertical rollers revolving inside the ring. Particle sizes of as low as about 30 $\mu\text{m}$ can be produced.

Roll Crusher	A machine for the comminution, or size reduction, of mineral lumps or stones. Such machines crush the input material between a plate and revolving roller or between more than one roller.
Roll Mill	A device for imparting shear to a dispersion for the purpose of reducing the particle size of the dispersed material. Somewhat similar to a roll crusher. Examples of dispersions processed over a roll mill are pigment grinds (pigments dispersed in a fluid such as castor oil) and soap formulations (where the dispersed material includes fragrance oil droplets and pigments).
Ross–Miles Test	A method for assessing foam stability in which one measures the rate of collapse of a (static) column of foam that has been generated by allowing a certain quantity of foaming solution to fall a specified distance into a separate volume of the same solution contained in a vessel. This technique is ASTM method D1173-53. <i>See also</i> Static Foam Test.
Salinity Requirement	<i>See</i> Optimum Salinity.
Salt Curve	A graphical representation of the viscosity of a system versus salt concentration. This curve can be an important characteristic of formulated systems in which viscosity control is necessary, such as in shampoo formulas.
Salting In/Out	<p>Solutions: Salting in is when the addition of electrolyte to a solution causes an increase in the solubility of a specified solute. Salting out is when the addition of electrolyte causes a decrease in the solubility.</p> <p>Surfactants: Salting in is when the addition of electrolyte to a solution of non-ionic surfactant causes the critical micelle concentration to increase. Also, addition of electrolyte to an ionic surfactant solution in a multiphase system can drive surfactant from the oil phase into the aqueous phase. Salting out is when the addition of electrolyte causes the critical micelle concentration to decrease. Also, addition of electrolyte to an ionic surfactant solution in a multiphase system can drive surfactant from the aqueous phase into the oil phase.</p> <p>Emulsions: Salting out is the process of demulsification by the addition of electrolyte.</p>
Sand	A term used to distinguish particles having different sizes in the range of about 50–63 $\mu\text{m}$ and about 2000 $\mu\text{m}$ , and with several subcategories, all depending on the operational scale adopted.
Saponification	The reaction of a fat or a fatty acid with a base to produce soap.



Scavenging Flotation	A flotation separation process, in which particles or droplets become attached to gas bubbles that are injected (sparged) into the flotation medium. Also termed “induced gas flotation”. Example: the froth flotation of bitumen. <i>See also</i> Froth Flotation.
Schulze–Hardy Rule	An empirical rule summarizing the general tendency of the critical coagulation concentration (CCC) of a suspension, an emulsion, or other dispersion, to vary inversely with about the sixth power of the counter-ion charge number of added electrolyte. Also termed the “sixth-power law”.
SEAR	<i>See</i> Surfactant Enhanced Aquifer Remediation.
Seaweed Colloids	A class of hydrophilic colloids (hydrocolloids) derived from various seaweeds. This class includes agar, algin, furcellaran, and carrageenan.
Sediment	The process of sedimentation in a dilute dispersion generally produces a discernible, more concentrated dispersion, which is termed the “sediment” and has a volume termed the “sediment volume”.
Sedimentation	The settling of suspended particles or droplets due to gravity or an applied centrifugal field. The rate of this settling is the sedimentation rate (or velocity). The sedimentation rate divided by acceleration is termed the “sedimentation coefficient”. The sedimentation coefficient extrapolated to zero concentration of sedimenting species is termed the “limiting sedimentation coefficient”. The sedimentation coefficient reduced to standard temperature and solvent is termed the “reduced sedimentation coefficient”. If extrapolated to zero concentration of sedimenting species it is termed the “reduced limiting sedimentation coefficient”. Negative sedimentation is also called “flotation”. Flotation in which droplets rise upwards is also called “creaming”. Flotation in which particulate matter becomes attached to gas bubbles is also referred to as “froth flotation”. <i>See also</i> Creaming, Froth Flotation, Subsidence.
Sedimentation Coefficient	<i>See</i> Sedimentation.
Sedimentation Equilibrium	The state of a colloidal system in which sedimentation and diffusion are in equilibrium.
Sediment Volume	<i>See</i> Sediment.
Self-Assembling Colloid	<i>See</i> Association Colloid.

Sensing Zone Technique	A general term used to refer to any of the particle or droplet-sizing techniques that rely on (usually) conductivity or capacitance changes in sample introduced between charged electrodes. Also termed “resistazone counter”. An example is the Coulter counter. The term “sensing zone technique” is also used with reference to similar techniques that use light absorption or scattering instead of electrical properties, <i>see</i> Photozone Counter.
Sensitization	The process in which small amounts of added hydrophilic colloidal material make a hydrophobic colloid more sensitive to coagulation by electrolyte. Example: the addition of polyelectrolyte to an oil-in-water emulsion to promote demulsification by salting out. Higher additions of the same material usually make the emulsion less sensitive to coagulation, and this is termed “protective action” or “protection”. The protected, colloiddally stable dispersions that result in the latter case are termed “protected lyophobic colloids”.
Separator	In the petroleum industry, a vessel designed to separate the oil phase in a petroleum fluid from some or all of the other three constituent phases: gas, solids, and water. Free-water knockouts fall under this category, but so do separators capable of breaking and removing water and solids from emulsions. The latter range from gravity to impingement (coalescence) to centrifugal separators.
Septum	In general, any dividing wall between two cavities. Example: the thin liquid films (lamellae) between bubbles in a foam.
Settling Radius	<i>See</i> Equivalent Spherical Diameter.
Silicone Oil	Any of a variety of silicon-containing polymer solutions. An example is a linear poly(dimethylsiloxane): $\text{HO}[(\text{CH}_3)_2\text{SiO}]_n\text{H}$ .
Silt	A term used to distinguish particles having sizes of greater than about 2–4 $\mu\text{m}$ and less than about 50–63 $\mu\text{m}$ , depending on the operational scale adopted.
Sintering	The coalescence or merging of two or more solid particles into a single particle.
Slip Casting	In ceramics, the process in which a slurry of dispersed particles is poured into a mould, the liquid removed, and the particles sintered to form the final product.
Slugging Compound	<i>See</i> Knockout Drops.
Slurry Quality	In suspensions, the concentration of solid particles. In foams containing solids, the volume fraction of gas plus solid in the foam. <i>See also</i> Foam Quality.

Soap	A surface-active fatty acid salt containing at least eight carbon atoms. The term is no longer restricted to fatty acid salts originating from natural fats and oils. <i>See also</i> Surfactant.
Soap Curd	A mixture of soap crystals in a saturated solution in which the soap crystals produce a gel-like consistency. The soap crystals in this case are referred to as “curd-fibres”. Soap curd is not a mesomorphic (liquid-crystal) phase.
Soap Film	A thin film of water in air that is stabilized by surfactant. The term is used even though the film is not a film of soap and even where the surfactant is not a soap. <i>See also</i> Fluid Film.
Soil	Naturally occurring unconsolidated material, whether mineral or organic, that is on the earth’s surface and is capable of supporting plant growth.
Solubilizate	The solute whose solubility is increased in the process of solubilization.
Solubilization	The process by which the solubility of a solute is increased by the presence of another solute. Micellar solubilization refers to the incorporation of a solute (solubilizate) into or on micelles of another solute to thereby increase the solubility of the first solute.
Solubilizing Agent	Any product that can be used to aid in the solubilization of a species. Examples: solubilizing agents for dyestuffs or pigments. Often a surfactant, such as a fatty acid derivative. <i>See also</i> Dispersant.
Spinning Oil	In the textile industry, a product applied to fibres in order to reduce friction, increase flexibility, and sometimes increase wetting, during combing and spinning operations.
Spinning Solution Additive	In the textile industry, a surface-active product added to spinning solution to improve spinning operations. Example: alkylsulfates. <i>See also</i> Spinning Oil.
Spotting Agent	In the textile industry, a product applied to fibres or fabrics to remove stains. Example: solvents formulated to contain surfactants such as alkylsulfates.
Static Foam Test	Any of several methods for assessing foam stability in which one measures the rate of collapse of a (static) column of foam. <i>See also</i> Dynamic Foam Test, Foaminess.
Static Mixer	A device for mixing components in a solution or dispersion without moving mechanical elements. Stationary flow-guiding elements are built into a device, frequently a section of pipe, and they induce mixing and dispersion by repeatedly dividing and recombining partial streams of the flowing material. Also termed “motionless mixers”.

Steric Stabilization	The stabilization of dispersed species induced by the interaction (steric stabilization) of adsorbed polymer chains. Example: adsorbed proteins stabilize the emulsified oil (fat) droplets in milk by steric stabilization. Also termed depletion stabilization. <i>See also</i> Protection.
Stiff Foam	An oil and gas-well drilling fluid foam that contains film-stabilizing additives, such as polymers or clays; is preformed at the surface; and is more viscous than stable foam, having sufficient carrying capacity to remove drill cuttings from large diameter holes. Also termed “gel foam”. <i>See also</i> Air Drilling Fluid, Foam Drilling Fluid, Stable Foam.
Stokes Diameter	<i>See</i> Equivalent Spherical Diameter.
Streamline Flow	<i>See</i> Laminar Flow.
Sublation	A flotation process in which the solute of interest becomes adsorbed on the surface of gas bubbles and is recovered in an upper layer of immiscible liquid.
Subsidence	The process of sedimentation in which the settling of suspended particles results in a dense compaction, or coagulation, of particles in which liquid is squeezed out. Geologically, significant compaction of clay layers caused by lowering of the water table (dewatering).
Suds Control Agents	Components in detergent formulations that act to stabilize or suppress sudsing (foaming). Examples: Alkylamine oxides can be added to promote or stabilize sudsing; silicones can be added to suppress sudsing (defoaming).
Surfactant	Any substance that lowers the surface or interfacial tension of the medium in which it is dissolved. The substance does not have to be completely soluble and can lower surface or interfacial tension by spreading over the interface. Soaps (fatty acid salts containing at least eight carbon atoms) are surfactants. Detergents are surfactants, or surfactant mixtures, whose solutions have cleaning properties. Also referred to as “surface-active agents” or, for synthetic surfactants, “tensides”. In some usage, surfactants are defined as “molecules capable of associating to form micelles”.
Surfactant Effectiveness	The surface excess concentration of surfactant corresponding to saturation of the surface or interface. Example: one indicator of effectiveness is the maximum reduction in surface or interfacial tension achievable by a surfactant. This term has a different meaning from surfactant efficiency.

Surfactant Efficiency	The equilibrium solution surfactant concentration needed to achieve a specified level of adsorption at an interface. Example: one such measure of efficiency is the surfactant concentration needed to reduce the surface or interfacial tension by 20 mN/m from the value of the pure solvent(s). This term has a different meaning from surfactant effectiveness.
Surfactant Enhanced Aquifer Remediation	(SEAR) A remediation technology based on reservoir chemical flooding principles (micellar solubilization and/or low interfacial tension flooding) and applied to the treatment of NAPL-contaminated soils.
Suspended Load	The particles that are picked up and carried along by streams and rivers, maintained in suspension by turbulence. The colloidal-sized fraction, particles of up to about 0.1 $\mu\text{m}$ in diameter, that may be able to remain in suspension for considerable periods of time, even in quiescent waters, is called the wash load.
Suspending Power	The ability of a detergent or detergent component to keep foreign material away from the solid material from which it has been removed to prevent re-deposition. <i>See also</i> Detergent.
Suspension	A system of solid particles dispersed in a liquid. Suspensions were previously referred to as "suspensoids", meaning suspension colloids. Aside from the obvious definition of a colloidal suspension, a number of operational definitions are common in industry, such as any dispersed matter that can be removed by a 0.45 $\mu\text{m}$ nominal pore-size filter.
Suspension Film	<i>See</i> Liquid Film.
Suspo-emulsion	A mixed colloidal dispersion in which a suspension is combined with an emulsion. Example: some kinds of emulsion-based paints.
Sweep Flocculation	A mechanism of aggregation or flocculation in which particles are enmeshed by a coagulant matrix. The particles are aggregated not due to charge neutralization but rather to enmeshment. Example: the rapid precipitation of a metal hydroxide from supersaturated solution where the settling fluffy hydroxide particles trap and enmesh other suspended particles.
Swelling	Increase in volume associated with the uptake of liquid or gas by a solid or a gel.
Swelling Pressure	The pressure difference between a swelling material and the bulk of fluid being imbibed that is needed to prevent additional swelling. <i>See also</i> Swelling.
Syndet	A synthetic detergent other than a soap.

Syneresis	The spontaneous shrinking of a colloidal dispersion due to the release and exudation of some liquid; frequently occurs in gels and foams but also occurs in flocculated suspensions. Mechanical syneresis refers to enhancing syneresis by the application of mechanical forces. Microsyneresis is a special case of syneresis in which the polymer molecules cluster together while retaining some of the original bulk gel structure. This process creates regions of free liquid within the gel network.
Tactoid	(1) In the de-stabilization of lyophilic colloids when coagulation occurs, the dispersed phase can initially separate into small, anisotropic droplets having shapes such as cylinders, called “tactoids”. With concentrated colloids, droplets of dilute colloid can separate out within the concentrated colloid; these droplets are sometimes referred to as “negative tactoids”. (2) In clay suspensions the thin sheet-like or plate-like particles can aggregate to form stacks of particles in face-to-face orientation, which are termed “tactoids”.
Tall Oil	Fatty and resinous carboxylic acids obtained from the sulfate process used to obtain cellulose from softwood trees.
TDS	Total dissolved solids.
Tenside	A synthetic surfactant. <i>See</i> Surfactant.
Thermodynamic Stability	In colloid science, the terms “thermodynamically stable” and “metastable” mean that a system is in a state of equilibrium corresponding to a local minimum of free energy (Ref. [978]). If several states of energy are accessible, the lowest is referred to as the “stable state” and the others are referred to as “metastable states”; unstable states are not at a local minimum. Most colloidal systems are metastable or unstable with respect to the separate bulk phases. <i>See also</i> Colloid Stability, Kinetic Stability.
Three-Phase Emulsion	<i>See</i> Multiple Emulsion.
Three-Phase Separator	<i>See</i> Separator.
Tight Emulsion	A petroleum industry term for a practically stable emulsion, in contrast to a less stable, or “loose”, emulsion.
Transition Velocity	The flow velocity in a pipe or stirred vessel that corresponds to a transition from laminar to turbulent flow conditions, or vice versa. <i>See also</i> Critical Deposition Velocity.

Treater	A vessel used for the breaking of emulsions and the consequent removal of solids and water (BS&W). Emulsion breaking can be accomplished through some combination of thermal, electrical, chemical, or mechanical methods. A treater might be applied to break an emulsion and separate solids and water that could not be removed in a separator.
Triple Emulsion	<i>See</i> Multiple Emulsion.
Turbulent Flow	A condition of flow in which all components of a fluid passing a certain point do not follow the same path. Turbulent flow refers to flow that is not laminar, or streamlined.
Ultrasonic Dispersion	The use of ultrasound waves to achieve or aid in the dispersion of particles or droplets.
Upper-Phase Microemulsion	A microemulsion with a high oil content that is stable while in contact with a bulk water phase, and in laboratory tube or bottle tests it tends to be situated at the top of the tube above the water phase. For chlorinated organic liquids, which are more dense than water, the oil will be the top phase rather than the bottom. <i>See also</i> Microemulsion, Winsor Type Emulsions.
Velocity Gradient	A parameter that indicates the intensity of mixing. It is a function of the power input, the reactor volume, and the fluid viscosity. Higher velocity gradients are used in coagulation where the goal is to disperse the coagulant to the particle surfaces. Lower velocity gradients are used in flocculation where the goal is particle collisions and aggregation, and higher gradients would break up flocs.
Versator	A device used for de-aerating liquid systems, such as emulsions, and operates on the principle of centrifugally generating a thin film of the liquid with high shear and exposing the thin film to vacuum.
Vesicle	A droplet characterized by the presence at its surface of a lipid bi-molecular film (bi-layer) or series of concentric bi-layers. A vesicle can be single or multi-lamellar and stabilized by natural or synthetic surfactants. Multi-lamellar vesicles are also termed liposomes. <i>See also</i> Bi-molecular Film.
Viscosity Modifier	An additive, such as a polymer, that reduces a fluid's viscosity variations with temperature.
Votator	A continuous-process device for rapidly changing the temperature of a liquid system. Liquid enters the device, is spread in a thin film over a heat-exchanging surface, is then removed from the surface by wall scrapers, and then exits the device through an outlet.

Wash Load	See Suspended Load.
Wet Oil	An oil containing free water or emulsified water.
Wetting Film	See Liquid Film.
Wetting Hysteresis	A phenomenon in which the work involved in introducing a solid surface into a liquid is different from the work involved in withdrawing it.
Whey	A term in dairy processing referring to the dilute oil-in-water emulsion that separates from the coagulated portion, or curd, in cheese-making.
Whey-Off	A term in dairy processing referring to any unwanted process in which whey separates from a product.
Whipping Agent	See Foaming Agent.
Winding Oil	In the textile industry, a product applied to yarns to reduce friction and increase flexibility to improve operations such as knitting. Example: oils formulated with surfactants to make them emulsifiable in water.
Winsor Type Emulsions	Several categories of microemulsions that refer to equilibrium phase behaviours and that distinguish, for example, the number of phases that can be in equilibrium and the nature of the continuous phase. They are denoted as Winsor Type I (oil-in-water), Type II (water-in-oil), Type III (most of the surfactant is in a middle phase with oil and water), and Type IV (water, oil, and surfactant are all present in a single phase). The Winsor Type III system is sometimes referred to as a “middle-phase microemulsion”, and the Type IV system is often referred to simply as a “microemulsion”. An advantage of the Winsor category system is that it is independent of the density of the oil phase and can lead to less ambiguity than do the lower-phase or upper-phase microemulsion type terminology. Nelson type emulsions are similarly identified, but with different type numbers.
W/O	Abbreviation for a water-dispersed-in-oil emulsion.
W/O/W	In multiple emulsions: Abbreviation for a water-dispersed-in-oil-dispersed-in-water multiple emulsion. Here the oil droplets have water droplets dispersed within them, and the oil droplets themselves are dispersed in water, forming the continuous phase. In fluid films: Abbreviation for a thin fluid film of oil in a water phase. Note the possibility of confusion with the multiple emulsion convention. See also Fluid Film.
Zwitterionic Surfactant	A surfactant molecule that contains negatively and positively charged groups. Example: lauramidopropylbetaine, $C_{11}H_{23}CONH(CH_2)_3N^+(CH_3)_2CH_2COO^-$ , at neutral and alkaline solution pH. See Amphoteric Surfactant.





## 18

## References

- 1 van Olphen, H. *An Introduction to Clay Colloid Chemistry*, 2<sup>nd</sup> ed., Wiley-Interscience: New York, 1977.
- 2 Schramm, L.L. (Ed.), *Emulsions: Fundamentals and Applications in the Petroleum Industry*, American Chemical Society: Washington, 1992.
- 3 Schramm, L.L. (Ed.), *Foams: Fundamentals and Applications in the Petroleum Industry*, American Chemical Society, Washington, 1994.
- 4 Schramm, L.L. (Ed.), *Suspensions: Fundamentals and Applications in the Petroleum Industry*, American Chemical Society: Washington, 1996.
- 5 Schramm, L.L. (Ed.), *Surfactants: Fundamentals and Applications in the Petroleum Industry*, Cambridge University Press: Cambridge, UK, 2000.
- 6 Kerker, M. J. *Colloid Interface Sci.*, 1987, 116, 296–299.
- 7 Asimov, I. *Words of Science and the History Behind Them*; Riverside Press: Cambridge, MA, 1959.
- 8 Freundlich, H. *Colloid and Capillary Chemistry*; English translation of 3rd. ed., Methuen: London, 1926.
- 9 Schramm, L.L. *The Language of Colloid and Interface Science*, American Chemical Society: Washington, 1993.
- 10 Schramm, L.L. *Dictionary of Colloid and Interface Science*, Wiley: New York, 2001.
- 11 Becher, P. *Dictionary of Colloid and Surface Science*, Dekker: New York, 1990.
- 12 Shaw, D.J. *Introduction to Colloid and Surface Chemistry*, 3<sup>rd</sup> ed., Butterworths: London, 1980.
- 13 Hiemenz, P.; Rajagopalan, R. *Principles of Colloid and Surface Chemistry*, 3<sup>rd</sup> ed., Dekker: New York, 1997.
- 14 Myers, D. *Surfaces, Interfaces, and Colloids*; 2<sup>nd</sup> ed., Wiley-VCH: New York, 1999.
- 15 Adamson, A.W. *Physical Chemistry of Surfaces*; 5<sup>th</sup> ed.; Wiley: New York, 1990.
- 16 Kruyt, H.R. *Colloid Science, Volume I, Irreversible Systems*, Elsevier: Amsterdam, 1952.
- 17 Mysels, K.J., *Introduction to Colloid Chemistry*, Interscience: New York, 1959.
- 18 Kruyt, H.R. *Colloid Science, Volume II, Reversible Systems*, Elsevier: Amsterdam, 1949.
- 19 Van Olphen, H.; Mysels, K.J. (Eds.) *Physical Chemistry: Enriching Topics from Colloid and Surface Science*, Theorex: La Jolla, CA, 1975.
- 20 Parfitt, G.D. *Principles of the Colloidal State*, Royal Institute of Chemistry: London, UK, 1967.
- 21 Osipow, L.I. *Surface Chemistry Theory and Industrial Applications*; Reinhold: New York, 1962.
- 22 Holmberg, K. (Ed.) *Handbook of Applied Surface and Colloid Chemistry*, Vol. 1, Wiley, New York, 2001.
- 23 Jirgensons, B.; Straumanis, M.E. *Colloid Chemistry*, 2<sup>nd</sup> ed., Pergamon Press: New York, 1962.
- 24 Hirtzel, C.S.; Rajagopalan, R. *Colloidal Phenomena, Advanced Topics*, Noyes Publ.: Park Ridge, NJ, 1985.
- 25 Ross, S.; Morrison, I.D. *Colloidal Systems and Interfaces*, Wiley: New York, 1988.
- 26 Vold, R.D.; Vold, M.J. *Colloid and Interface Chemistry*, Addison-Wesley: Reading, Mass., 1983.
- 27 Russel, W.B.; Saville, D.A.; Schowalter, W.R. *Colloidal Dispersions*, Cambridge University Press: Cambridge, 1991.

- 28 Everett, D. H. *Basic Principles of Colloid Science*, Royal Society of Chemistry: London, 1988.
- 29 Parker, S.P. (Ed.), *McGraw-Hill Dictionary of Scientific and Technical Terms*, 3<sup>rd</sup> ed., McGraw-Hill: New York, 1984.
- 30 Lowell, S.; Shields, J.E. *Powder Surface Area and Porosity*, Chapman and Hall: London, 1991.
- 31 Myers, D. *Surfactant Science and Technology*, VCH: New York, 1988.
- 32 Rosen, M.J. *Surfactants and Interfacial Phenomena*; 2<sup>nd</sup> ed., Wiley: New York, 1989.
- 33 El-Nokaly, M.; Cornell, D. (Eds.), *Microemulsions and Emulsions in Foods*, American Chemical Society: Washington, 1991.
- 34 Beckett, R. (Ed.), *Surface and Colloid Chemistry in Natural Waters and Water Treatment*, Plenum Press: New York, 1990.
- 35 Rieger, M.M.; Rhein, L.D. (Eds.), *Surfactants in Cosmetics*, 2<sup>nd</sup> ed., Dekker: New York, 1997.
- 36 Dickinson, E. *An Introduction to Food Colloids*, Oxford University Press: New York, 1992.
- 37 Becher, P. *Emulsions: Theory and Practice*, 3<sup>rd</sup> ed., American Chemical Society: Washington, 2001.
- 38 Lissant, K.J., *Demulsification, Industrial Applications*, Marcel Dekker, New York, 1983.
- 39 Sumner, C.G. *Clayton's The Theory of Emulsions and Their Technical Treatment*, 5<sup>th</sup> ed.; Blakiston Co. Inc.: New York, 1954.
- 40 Becher, P. (Ed.), *Encyclopedia of Emulsion Technology*, Vol's. 1-3, Dekker: New York, 1983, 1985, 1988.
- 41 Mittal, K.L. (Ed.) *Micellization, Solubilization and Microemulsions*, Vols. 1,2, Plenum: New York, 1977.
- 42 Shah, D.O. (Ed.) *Macro- and Microemulsions*, American Chemical Society: Washington, 1985.
- 43 Bikerman, J. J.; Perri, J.M.; Booth, R.B.; Currie, C.C. *Foams: Theory and Industrial Applications*, Reinhold: New York, 1953.
- 44 Akers, R.J. (Ed.) *Foams*, Academic Press: New York, 1976.
- 45 Isenberg, C. *The Science of Soap Films and Soap Bubbles*, Tieto: Clevedon, England, 1978.
- 46 Bikerman, J.J. *Foams*, Springer-Verlag: New York, 1973.
- 47 Wilson, A.J. (Ed.) *Foams: Physics, Chemistry, and Structure*, Springer-Verlag: London, 1989.
- 48 van Olphen, H. *An Introduction to Clay Colloid Chemistry*, 2<sup>nd</sup> ed.; Wiley-Interscience: New York, 1977.
- 49 Yariv, S.; Cross, H. *Geochemistry of Colloid Systems for Earth Scientists*, Springer-Verlag: Berlin, 1979.
- 50 Jaycock, M.J.; Parfitt, G.D. *Chemistry of Interfaces*, Ellis Horwood: Chichester, UK, 1981.
- 51 Iler, R.K.; *The Chemistry of Silica: Solubility, Polymerization, Colloid and Surface Properties and Biochemistry*, Wiley: New York, 1979.
- 52 Garti, N.; Bisperink, C. *Curr. Opinion Colloid Interface Sci.*, **1998**, 3, 657-667.
- 53 Nguyen, A.V.; Schulze, H.J. *Colloidal Science of Flotation*, Marcel Dekker, New York, 2004, 850 pp.
- 54 Montminy, M.D.; Tannenbaum, A.R.; Macosko, C.W. *J. Colloid Interface. Sci.* **2004**, 280, 202-211.
- 55 Schramm, L.L. *Studies on Particle-Ion and Particle-Particle Interaction Effects in Clay Suspensions*, Ph.D. Thesis, Dalhousie University, Halifax, N.S., 1980.
- 56 Di Felice, R. Solid Suspension in Liquid Fluidized Beds in *Processing of Solid-Liquid Suspensions*, Shamlou, P.A. (Ed.), Butterworth-Heinemann: Boston, 1993, pp. 246-272.
- 57 Veale, C.R. *Fine Powders*, Wiley: New York, 1972.
- 58 Beddow, J.K. *Particulate Science and Technology*, Chemical Publishing: New York, 1980.
- 59 Parfitt, G.D.; Sing, K.S.W. (Eds.) *Characterization of Powder Surfaces*, Academic Press: New York, 1976.
- 60 Shaw, D.J. *Introduction to Colloid and Surface Chemistry*, 2<sup>nd</sup> ed ed., Butterworths: London, 1966.
- 61 Brinker, C.J.; Sherer, G.W. *Sol-Gel Science: The Physics and Chemistry of Sol-Gel Processing*, Academic Press: San Diego, 1990.
- 62 Yu, L.; Wardlaw, N.C. Quantitative Determination of Pore Structure from Mercury Capillary Pressure Curves in *Interfacial Phenomena in Petroleum Recovery*, Morrow, N.R. (Ed.), Dekker: New York, 1991, pp. 101-156.
- 63 Galopin, R.; Henry, N.F.M. *A Microscopic Study of Opaque Minerals*, Heffer and Sons: Cambridge, 1972.
- 64 Mason, C.W. *Handbook of Chemical Microscopy*, Vol 1, Wiley: New York, 1983.
- 65 Munoz, V.A.; Mikula, R.J. *J. Can. Petrol. Technol.*, **1997**, 38, 36-40.

- 66 Mikula, R.J. Emulsion Characterization in: *Emulsions, Fundamentals and Applications in the Petroleum Industry*, Schramm, L.L., (Ed.), American Chemical Society: Washington, 1992, pp. 79–129.
- 67 Pawley, J.B., (Ed.) *Handbook of Biological Confocal Microscopy*, Plenum Press: New York, 1990.
- 68 Mikula, R.J.; Munoz, V.A. Characterization of Demulsifiers in *Surfactants, Fundamentals and Applications in the Petroleum Industry*, Schramm, L.L. (Ed.), Cambridge University Press: Cambridge, UK, 2000, pp. 51–78.
- 69 Salama, A.I.A.; Mikula, R.J. Particle and Suspension Characterization in *Suspensions, Fundamentals and Applications in the Petroleum Industry*, Schramm, L.L. (Ed.), American Chemical Society: Washington, 1996, pp. 45–106.
- 70 Schramm, L.L.; Kutay, S.M.; Mikula, R.J.; Munoz, V.A. *J. Petrol. Sci. Eng.*, **1999**, *23*, 117–132.
- 71 Kutay, S.M.; Schramm, L.L. *J. Can. Petrol. Technol.*, **2004**, *43*, 19–28.
- 72 Burauer, S.; Belkoura, L.; Stubenrauch, C.; Strey, R. *Coll. Surf. A* **2003**, *228*, 159–170.
- 73 Wilson, A.J. Cryo-Microscopical Methods for the Investigation of Foam Structure in *Foams: Physics, Chemistry, and Structure*, Wilson, A.J. (Ed.), Springer-Verlag: London, 1989, pp. 69–88.
- 74 Orr, C. *Particulate Technology*, Macmillan: New York, 1966.
- 75 Kerker, M. *The Scattering of Light and Other Electromagnetic Radiation*, Academic Press: New York, 1969.
- 76 Morrison, I.D.; Ross, S. *Colloidal Dispersions*, Wiley-Interscience: New York, 2002.
- 77 Van der Hulst, H.C., *Light Scattering by Small Particles*, Chapman and Hall: London, 1957.
- 78 Dalglish, D.G., Food Emulsions in *Emulsions and Emulsion Stability*, J. Sjoblom (Ed.), Marcel Dekker: New York, 1996, pp. 287–325.
- 79 Gunier, A.; Fournet, G. *Small Angle Scattering of X-Rays*, Wiley: New York, 1955.
- 80 Herbst, L.; Hoffmann, H.; Kalus, J.; Thurn, H.; Ibel, K. *Neutron Scattering in the Nineties*, International Atomic Energy Agency: Vienna, Austria, 1985.
- 81 Hunter, R.J. *Zeta Potential in Colloid Science*, Academic Press: New York, 1981.
- 82 Babchin, A.J.; Chow, R.S.; Sawatzky, R.P. *Adv. Colloid Interface Sci.*, **1989**, *30*, 111–151.
- 83 Williams, R.A.; Simons, S.J.R. Handling Colloidal Materials in *Colloid and Surface Engineering*, Williams, R.A. (Ed.), Butterworth-Heinemann: Oxford, 1992; pp. 55–111.
- 84 Laskowski, J.S.; Pugh, R.J. Dispersions Stability and Dispersing Agents in *Colloid Chemistry in Mineral Processing*, Laskowski, J.S.; Ralston, J. (Eds.), Elsevier: Amsterdam, 1992, pp. 115–171.
- 85 Nasr-El-Din, H.A. Fluid Dynamics of Oil-Water-Sand Systems in *Emulsions, Fundamentals and Applications in the Petroleum Industry*, Schramm, L.L. (Ed.), American Chemical Society: Washington, 1992, pp. 171–217.
- 86 Nasr-El-Din, H.A. Flow of Suspensions in Pipelines in *Suspensions, Fundamentals and Applications in the Petroleum Industry*, Schramm, L.L. (Ed.), American Chemical Society: Washington, 1996, pp. 177–225.
- 87 Hiemenz, P.C. *Principles of Colloid and Surface Chemistry*, 2nd. Ed., Dekker: N.Y., 1986.
- 88 Allen, T. *Particle Size Measurement*, 4<sup>th</sup> ed., Chapman and Hall: New York, 1990.
- 89 Syvitski, J.P.M., (Ed.), *Principles, Methods and Applications of Particle Size Analysis*, Cambridge University Press: Cambridge, UK, 1991.
- 90 Shook, C.A.; Gillies, R.G.; Sanders, R.S. *Pipeline Hydrotransport with Applications in the Oil Sand Industry*, Saskatchewan Research Council: Saskatoon, SK, 2002.
- 91 Leja, J. *Surface Chemistry of Froth Flotation*, Plenum Press: N.Y., 1982.
- 92 Schramm, L.L., *J. Can. Petrol. Technol.*, **1989**, *28*, 73–80.
- 93 Barnes, H.A.; Holbrook, S.A. High Concentration Suspensions: Preparation and Properties In *Processing of Solid-Liquid Suspensions*, Shamlou, P.A. (Ed.), Butterworth-Heinemann: Boston, 1993, pp. 222–245.
- 94 Robins, M.M. *Curr. Opinion Colloid & Interface Sci.* **2000**, *5*, 265–272.
- 95 Schramm, L.L. Petroleum Emulsions, Basic Principles in *Emulsions, Fundamentals and Applications in the Petroleum Industry*, Schramm, L.L. (Ed.), American Chemical Society: Washington, 1992, pp. 1–49.
- 96 Griffin, W.C. Emulsions in *Kirk-Othmer Encyclopedia of Chemical Technology*, 2nd ed., Vol. 8, Interscience: New York, 1965, pp. 117–154.
- 97 Schramm, L.L.; Kutay, S. Emulsions and Foams in the Petroleum Industry in *Surfactants: Fundamentals and Applications in the Pe-*

- roleum Industry*, Schramm, L.L. (Ed.), Cambridge University Press: Cambridge, UK, 2000, pp. 79–117.
- 98 Shaw, R.C.; Czarnecki, J.; Schramm, L.L.; Axelson, D. Bituminous Froths in the Hot-Water Flotation Process in *Foams Fundamentals and Applications in the Petroleum Industry*, Schramm, L.L., Ed., American Chemical Society: Washington, 1994; pp. 423–459.
  - 99 Leopold, G. Breaking Produced-Fluid and Process-Stream Emulsions in *Emulsions, Fundamentals and Applications in the Petroleum Industry*, Schramm, L.L., Ed., American Chemical Society: Washington, DC, 1992, pp. 342–383.
  - 100 Leman, J.; Kinsella, J.E. *Crit. Rev. Food Sci. Nutrition* **1989**, *28*, 115–138.
  - 101 Cavallo, J.L.; Chang, D.L. *Chem. Eng. Progress* **1990**, *86*, 54–59.
  - 102 Binks, B.P. *Ann. Repts. Royal Soc. Chem.* **1995**, *92C*, 97–133.
  - 103 Bulmer, J.T.; Starr, J. (Eds.), *Syncrude Analytical Methods for Oil Sand and Bitumen Processing*, Alberta Oil Sands Technology and Research Authority: Edmonton, Alberta, 1979.
  - 104 Institute of Petroleum (London), *Standard Methods for Analysis and Testing of Petroleum and Related Products*, Wiley: New York, 1988.
  - 105 *API Manual of Petroleum Measurement Standards*, American Petroleum Institute, Washington, DC, 1987.
  - 106 *Annual Book of ASTM Standards*, American Society for Testing and Materials, Philadelphia, PA, 1987.
  - 107 Mitchell, J.; Smith, D.M., *Aquameyry: a Treatise on Methods for the Determination of Water*, 2<sup>nd</sup> ed., Wiley: New York, 1980.
  - 108 Kokal, S.L., Maini, B.B., Woo, R. Flow of Emulsions in Porous Media in *Emulsions, Fundamentals and Applications in the Petroleum Industry*, Schramm, L.L. (Ed.), American Chemical Society: Washington, 1992, pp. 219–262.
  - 109 Weaire, D.; Hutzler, S.; Verbist, G.; Peters, E., *Adv. Chem. Phys.* **1997**, *102*, 315–374.
  - 110 Ross, S. Foams in *Kirk–Othmer Encyclopedia of Chemical Technology*, 3rd ed.; Vol. 11, Wiley: New York, 1980, pp. 127–145.
  - 111 Sebba, F. *J. Colloid Interface Sci.*, **1971**, *35*, 643–646.
  - 112 Sebba, F., *Foams and Biliquid Foams – Aphrons*, Wiley: New York, 1987.
  - 113 Sebba, F. *Chemistry and Industry*, **1985**, *4*, 91–93.
  - 114 Schramm, L.L. Foam Sensitivity to Crude Oil in *Foams, Fundamentals and Applications in the Petroleum Industry*, Schramm, L.L. (Ed.), American Chemical Society: Washington, DC, 1994, pp. 165–197.
  - 115 Ross, S.; Suzin, Y., *Langmuir*, **1985**, *1*, 145–149.
  - 116 ASTM Designation D1881-86, American Society for Testing and Materials: Philadelphia, PA, 1988.
  - 117 ASTM Designation D1173-53 (Reapproved 1986), American Society for Testing and Materials: Philadelphia, PA, 1988.
  - 118 ASTM Designation D892-74 (Reapproved 1984), American Society for Testing and Materials: Philadelphia, PA, 1988.
  - 119 ASTM Designation D3601-88, American Society for Testing and Materials: Philadelphia, PA, 1988.
  - 120 ASTM Designation D3519-88, American Society for Testing and Materials: Philadelphia, PA, 1988.
  - 121 Nishioka, G.; Ross, S. *J. Colloid Interface Sci.* **1981**, *81*, 1–7.
  - 122 Morrison, C.; Schramm, L.L.; Stasiuk, E.N. *J. Petrol. Sci. & Eng.*, **1996**, *15*, 91–100.
  - 123 Sutton, J.R. Formulation of Industrial Hygiene Products: Art or Science in *Industrial Applications of Surfactants*, Karsa, D.R. (Ed.), Royal Soc. Chem.: London, 1987, pp. 208–234.
  - 124 German, J.B. Properties of Stabilizing Components in Foams in *Food Emulsion and Foams: Theory and Practice*, Wan, P.J.; Cavallo, J.L.; Saleeb, F.Z.; McCarthy, M.J. (Eds.) *Am. Inst. Chem. Eng.*: New York, 1990, pp. 62–70.
  - 125 McDowell, R.S., Spectroscopy, Optical in *Kirk–Othmer Encyclopedia of Chemical Technology*, Wiley: New York, 1997 (Online version, 2000).
  - 126 Pemberton, J.E., Surface and Interface Analysis in *Kirk–Othmer Encyclopedia of Chemical Technology*, Online edition, posted December 4, 2000, Wiley: New York, 1998.
  - 127 Woodruff, D. P., Delchar, T. A. *Modern Techniques of Surface Science*, Cambridge University Press: New York, 1986.
  - 128 Somorjai, G.A., *Introduction to Surface Chemistry and Catalysis*, Wiley-Interscience: New York, 1994.

- 129 Montana, A.J. Analytical Methods, Trends in *Kirk-Othmer Encyclopedia of Chemical Technology*, Wiley: New York, 1992 (Online version, 2000).
- 130 Isaacs, E.E.; Chow, R.S. Practical Aspects of Emulsion Stability in *Emulsions, Fundamentals and Applications in the Petroleum Industry*, Schramm, L.L. (Ed.), American Chemical Society: Washington, 1992, pp. 51–77.
- 131 Walstra, P. *Chem. Eng. Sci.* **1993**, *48*, 333–349.
- 132 Walstra, P.; Smulders, I., Making Emulsions and Foams: An Overview in *Food Colloids: Proteins, Lipids and Polysaccharides*, Bergensstahl, E.; Dickinson, E. (Eds.), Royal Society of Chemistry: Cambridge, 1997, pp. 367–381.
- 133 Lake, L.W. *Enhanced Oil Recovery*, Prentice Hall: Englewood Cliffs, NJ, 1989.
- 134 Harkins, W.D.; Alexander, A.E. Determination of Surface and Interfacial Tension in *Physical Methods of Organic Chemistry*, Weissberger, A. (Ed.), Interscience: New York, 1959, pp. 757–814.
- 135 Padday, J.F. Surface Tension. Part II. The Measurement of Surface Tension in *Surface and Colloid Science*, Vol. 1, Matijevic, E. (Ed.), Wiley-Interscience: New York, 1969, pp. 101–149.
- 136 Miller, C.A.; Neogi, P. *Interfacial Phenomena Equilibrium and Dynamic Effects*, Dekker: New York, 1985.
- 137 Rusanov, A.I.; Prokhorov, V.A. *Interfacial Tension*, Elsevier: Amsterdam, 1996.
- 138 Cayias, J.L.; Schechter, R.S.; Wade, W.H. The Measurement of Low Interfacial Tension via the Spinning Drop Technique in *Adsorption at Interfaces*, Mittal, K.L. (Ed.), American Chemical Society: Washington, 1975, pp. 234–247.
- 139 Schramm, L.L.; Hepler, L.G. *Can. J. Chem.*, **1994**, *72*, 1915–1920.
- 140 Schurch, S.; Bachofen, H.; Goerke, J.; Possmayer, F. *J. Appl. Physiol.*, **1989**, *67*, 2389–2396.
- 141 Schramm, L.L.; Fisher, D.B.; Schürch, S.; Cameron, A. *Colloids Surfaces*, **1995**, *94*, 145–159.
- 142 Taylor, K.C., Schramm, L.L. *Colloids Surfaces*, **1990**, *47*, 245–253.
- 143 Janule, V. *Sensa-Dyne Surface Tensiometer Brochure*, Chem-Dyne Research Corp.: Milwaukee, WI, 1989.
- 144 Stasiuk, E.N.; Schramm, L.L. *Colloid Polymer Sci.*, **2000**, *278*, 1172–1179.
- 145 Schramm, L.L.; Stasiuk, E.N.; Turner, D. *Fuel Proc. Technol.* **2003**, *80*, 101–118.
- 146 Salmang, H.; Deen, W.; Vroemen, A. *Ber. Deutsch Keram. Ges.* **1957**, *34*, 33–38.
- 147 Taylor, D.; Howlett, D.J. *Trans. J. Brit. Ceram. Soc.* **1974**, *73*, 19–22.
- 148 Brian, B.W.; Chen, J.C. *AIChE J.* **1987**, *33*, 316–318.
- 149 Menon, V.B.; Nikolov, A.D.; Wasan, D.T. *J. Colloid Interface Sci.* **1988**, *124*, 317–327.
- 150 Menon, V.B.; Nikolov, A.D.; Wasan, D.T. *J. Dispersion Sci. Technol.*, **1988/89**, *9*, 575–593.
- 151 Menon, V.B.; Wasan, D.T. *Colloids Surfaces*, **1988**, *29*, 7–27.
- 152 Parfitt, G.D. (Ed.), *Dispersion of Powders in Liquids*, 3<sup>rd</sup> ed., Applied Science: London, 1981.
- 153 Neuman, A.W., *Adv. Colloid and Interface Sci.*, **1974**, *4*, 105–191.
- 154 Soulard, M.R.; Vargha-Butler, E.I.; Hamza, H.A.; Neuman, A.W. *Chem. Eng. Commun.*, **1983**, *21*, 329–344.
- 155 Fuerstenau, D.W.; Williams, M.C. *Colloids Surfaces* **1987**, *22*, 87–91.
- 156 Marmur, A.; Chen, W.; Zografi, G. *Colloids Surfaces*, **1986**, *113*, 114–120.
- 157 Anderson, W.G. *J. Petrol. Technol.* **1986**, *38*, 1246–1262.
- 158 Spinler, E.A.; Baldwin, B.A. Surfactant Induced Wettability Alteration in Porous Media in *Surfactants, Fundamentals and Applications in the Petroleum Industry*, Schramm, L.L. (Ed.), Cambridge University Press: Cambridge, UK, 2000, pp. 159–202.
- 159 Cuiec, L.E. Evaluation of Reservoir Wettability and Its Effect on Oil Recovery in *Interfacial Phenomena in Petroleum Recovery*, Morrow, N.R. (Ed.), Dekker: New York, 1991, pp. 319–376.
- 160 Karsa, D.R. (Ed.) *Industrial Applications of Surfactants*, Royal Society of Chemistry: London, 1987.
- 161 Lucassen-Reynders, E.H., Ed., *Anionic Surfactants, Physical Chemistry of Surfactant Action*, Dekker: New York, NY, 1981.
- 162 Rieger, M.M. Surfactant Chemistry and Classification in *Surfactants in Cosmetics*, 2<sup>nd</sup> ed., Rieger, M.M.; Rhein, L.D. (Eds.), Dekker: New York, 1997, pp. 1–28.
- 163 Schramm, L.L.; Stasiuk, E.N.; Marangoni, G. *Ann. Repts. Progr. Chem. (Royal Soc. Chem.), Sect. C*, **2003**, *99*, 3–48.

- 164 Britton, L. Toxicity and Persistence of Surfactants used in the Petroleum Industry in *Surfactants, Fundamentals and Applications in the Petroleum Industry*, Schramm, L.L. (Ed.), Cambridge University Press: Cambridge, 2000, pp. 541–565.
- 165 Britton, L.N. *J. Surf. Det.*, **1998**, *1*, 109–117.
- 166 *Environmental and Human Safety of Major Surfactants*. Vol. I. Anionic Surfactants. A final report to The Soap and Detergent Assoc., New York by Arthur D. Little, Inc. Cambridge, MA, 1991.
- 167 Karsa, D.R.; Porter, M.R. (Eds.), *Biodegradability of Surfactants*, Blackie Academic: London, 1995.
- 168 Cross, J. (Ed.), *Anionic Surfactants – Chemical Analysis*, Dekker: New York, 1977.
- 169 Cross, J. (Ed.), *Nonionic Surfactants – Chemical Analysis*, Dekker: New York, 1986.
- 170 Porter, M.R. (Ed.), *Recent Developments in the Analysis of Surfactants*, Elsevier: Essex, 1991.
- 171 Schmitt, T.M. *Analysis of Surfactants*, 2<sup>nd</sup> ed., Dekker: New York, 2001.
- 172 Cullum, D.C. (Ed.), *Introduction to Surfactant Analysis*, Blackie: London, 1994.
- 173 Rosen, M.J.; Goldsmith, H.A. *Systematic Analysis of Surface-Active Agents*, 2<sup>nd</sup> ed., Wiley: New York, 1972.
- 174 Eldridge, J.M. The Analysis of Surfactants in Cosmetics in *Surfactants in Cosmetics*, 2<sup>nd</sup> ed., Rieger, M.M.; Rhein, L.D. (Eds.), Dekker: New York, 1997, pp. 83–104.
- 175 De Caro, C.A. *La Rivista Italiana Delle Sostanze Grasse* **1998**, *LXXV*, 197–204.
- 176 Wang, L.K.; Kao, S.F.; Wang, M.H.; Kao, J.F. *Ind. Eng. Chem. Prod. Res. Dev.* **1978**, *17*, 186–195.
- 177 Schwartz, A.M.; Perry, J.W.; Berch, J. *Surface-Active Agents and Detergents*, Vol. 2, Kreiger: New York, 1977.
- 178 Llenado, R.A.; Jamieson, R.A. *Anal. Chem.* **1981**, *53*, 174R–182R.
- 179 Epton, S.R. *Trans. Faraday Soc.* **1948**, *44*, 226–230.
- 180 Epton, S.R. *Nature*, **1947**, *160*, 795–796.
- 181 Glazer, J.; Smith, T.D. *Nature*, **1952**, *169*, 497–498.
- 182 Reid, V.W.; Longman, G.F.; Heinerth, E. *Tenside Surf. Det.*, **1967**, *4*, 292–304.
- 183 Schramm, L.L.; Smith, R.G.; Stone, J.A. *AOS-TRA J. Research*, **1984**, *1*, 5–14.
- 184 Takeuchi, T. *J. Chromatogr. A* **1997**, *780*, 219–228.
- 185 Rusling, J.F. Electrochemistry in Micelles, Microemulsions, and Related Organized Media in *Electroanalytical Chemistry*, Vol. 19, Bard, A.J. (Ed.), Marcel Dekker: New York, 1994, pp. 1–88.
- 186 Attwood, D.; Florence, A.T. *Surfactant Systems, Their Chemistry, Pharmacy and Biology*, Chapman and Hall: New York, 1983.
- 187 Hartley, G.S. *Aqueous Solutions of Paraffin Chain Salts*, Hermann and Cie: Paris, 1936.
- 188 Tanford, C. *The Hydrophobic Effect, The Formation of Micelles and Biological Membranes*, 2nd ed., Wiley: New York, 1980.
- 189 Mukerjee, P.; Mysels, K.J., *Critical Micelle Concentrations of Aqueous Surfactant Systems*, NSRDS-NBS 36, National Bureau of Standards: Washington, 1971.
- 190 Preston, W.C. *J. Phys. Colloid Chem.* **1948**, *52*, 84–97.
- 191 Huang, X.; Yang, J.; Zhang, W.; Zhang, Z.; An, Z. *J. Chem. Ed.* **1999**, *76*, 93–94.
- 192 Shinoda, K.; Nakagawa, T.; Tamamushi, B.I.; Isemura, T. *Colloidal Surfactants: Some Physicochemical Properties*, Academic Press: New York, 1963.
- 193 Rosen, M.J. and Dahanayake, M. *Industrial Utilization of Surfactants*, AOCs Press: Champaign, Illinois, 2000.
- 194 Israelachvili, J.N. *Intermolecular and Surface Forces*, 2nd ed., Academic Press: New York, 1992.
- 195 Schramm, L.L.; Mannhardt, K. *J. Petrol. Sci. Eng.*, **1996**, *15*, 101–113.
- 196 Sanchez, J.M.; Hazlett, R.D. *SPE Reservoir Eng.*, **1992**, *7*, 91–97.
- 197 Tatum, J.P. Organophilic Clays for Low-Toxicity Drilling Fluids in *Chemicals in the Oil Industry*, Ogden, P.H. (Ed.), Royal Society of Chemistry: London, 1988, pp. 31–36.
- 198 Brownson, G.; Peden, J.M. The Development and Application of Oil-Base Muds in *Chemicals in the Oil Industry*, Ogden, P.H. (Ed.), Royal Society of Chemistry: London, 1983, pp. 22–41.
- 199 Clunie, J.S.; Goodman, J.F.; Ingram, B.T. Thin Liquid Films in *Surface and Colloid Science*, Vol. 3, Matijevic, E. (Ed.), Wiley: New York, 1971, pp. 167–239.
- 200 Eastoe, J.; Dalton, J.S. *Adv. Coll. Interface Sci.* **2000**, *85*, 103–144.
- 201 Malysa, K.; Lunkenheimer, K.; Miller, R.; Hartenstein, C. *Colloids and Surfaces* **1981**, *3*, 329–338.

- 202 Schramm, L.L.; Green, W.H.F. *Colloid & Polymer Sci.* **1992**, *270*, 694–706.
- 203 Huang, D.D.W.; Nikolov, A.; Wasan, D.T. *Langmuir* **1986**, *2*, 672–677.
- 204 Lucassen-Reynders, E.H. Surface Elasticity and Viscoelasticity in Compression/Dilation in *Anionic Surfactants Physical Chemistry of Surfactant Action*, Lucassen-Reynders, E.H. (Ed.), Dekker: New York, 1981, pp.173–216.
- 205 Eastoe, J.; Dalton, J.S. *Adv. Colloid Interface Sci.*, **2000**, *85*, 103–144.
- 206 Cahn, A. and Lynn, J.L. Surfactants and Detergent Systems in *Kirk–Othmer Encyclopedia of Chemical Technology*, 3<sup>rd</sup> ed., Vol. 22, Wiley, New York, pp. 332–432, 1983.
- 207 Griffin, W.C. *J. Soc. Cosmetic Chem.* **1949**, *1*, 311–326.
- 208 Dingcong, W. *J. Colloid Interface Sci.* **2002**, *247*, 389–396.
- 209 *The HLB System*, ICI Americas Inc.: Wilmington, DE, 1976.
- 210 Courtney, D.L. Emulsifier Selection/HLB in *Surfactants in Cosmetics*, 2<sup>nd</sup> ed., Rieger, M.M.; Rhein, L.D. (Eds.), Dekker, New York, 1997, pp. 127–138.
- 211 *McCutcheon's Emulsifiers and Detergents*, Vol. 1, MC Publishing Co.: Glen Rock, NJ, 1990.
- 212 Shinoda, K.; Saito, H. *J. Colloid Interface Sci.* **1969**, *30*, 258–263.
- 213 Wadle, A.; Tesmann, H.; Leonard, M.; Förster, T. Phase Inversion in Emulsions: CAPICO–Concept and Application in *Surfactants in Cosmetics*, 2<sup>nd</sup> ed., Rieger, M.M.; Rhein, L.D. (Eds.), Dekker: New York, 1997, pp. 207–224.
- 214 Engels, T.; Förster, T.; von Rybinski, W. *Colloids Surfaces A*, **1995**, *99*, 141–149.
- 215 Sherman, P. *Industrial Rheology*, Academic Press: New York, 1970.
- 216 Adams, J.W., Silicones in the Coating Industry: Flow, Levelling and Defoaming in *Surface Phenomena and Additives in Water-Based Coatings and Printing Technology*, Sharma, M.K. (Ed.), Plenum Press: New York, 1991, pp. 73–87.
- 217 Vick, S.C. *Soap/Cosmetics/Chemical Specialties*, **1984**, *60*, 36.
- 218 Sabia, A.J. *American Dyestuff Reporter*, **1982**, *May*, 45.
- 219 Callaghan, I.C. Antifoams for Nonaqueous Systems in the Oil Industry in *Defoaming, Theory and Industrial Applications*, Garrett, P.R. (Ed.), Dekker: New York, 1993, pp. 119–150.
- 220 Stevens, P.J.G. *Pestic. Sci.*, **1993**, *38*, 103–122.
- 221 Knoche, M. *Weed Research* **1994**, *34*, 221–239.
- 222 Roggenbuck, F.C.; Rowe, L.; Penner, D.; Petroff, L.; Burow, R. *Weed Technol.* **1990**, *4*, 576–580.
- 223 Ling, T.F.; Lee, H.K.; Shah, D.O. in *Industrial Applications of Surfactants*, Karsa, D.R. (Ed.), Royal Society of Chemistry: London, 1987.
- 224 Prince, L.M. (Ed.) *Microemulsions Theory and Practice*, Academic Press: New York, 1977.
- 225 Tadros, Th.F. Surface Chemistry in Agriculture in *Handbook of Applied Surface and Colloid Chemistry*, Holmberg, K. (Ed.), Vol. 1, Wiley: New York, 2001, pp. 73–83.
- 226 Schwuger, M.-J.; Stickdorn, K.; Schomacker, R. *Chem. Rev.* **1995**, *95*, 849–864.
- 227 Taylor, K.; Hawkins, B. Emulsions in Enhanced Oil Recovery in *Emulsions, Fundamentals and Applications in the Petroleum Industry*, Schramm, L.L. (Ed.), American Chemical Society, Washington, DC, 1992, pp. 263–293.
- 228 Abe, M. *J. Jpn. Oil Chem. Soc.* **1998**, *47*, 819–843.
- 229 Austad, T.; Milner, J. Surfactant Flooding in Enhanced Oil Recovery in *Surfactants, Fundamentals and Applications in the Petroleum Industry*, Schramm, L.L. (Ed.), Cambridge University Press: Cambridge, 2000, pp. 203–249.
- 230 Graciaa, A.; Lachaise, J.; Cucuphat, C.; Bourrel, M.; Salager, J.L., *Langmuir*, **1993**, *9*, 669–672.
- 231 Acosta, E.; Mai, P.D.; Harwell, J.H.; Sabatini, D.A. *J. Surfactants Detergents*, **2003**, *6*, 353–363.
- 232 Shah, D.O. (Ed.), *Macro- and Microemulsions: Theory and Applications*, American Chemical Society: Washington, 1985.
- 233 Sabatini, D.A.; Knoz, R.C.; Harwell, J.H. (Eds.), *Surfactant-Enhanced Subsurface Remediation Emerging Technologies*, American Chemical Society: Washington, 1995.
- 234 Chhabra, V.; Free, M.L.; Kang, P.K.; Truesdail, S.E.; Shah, D.O. *Tenside Surf. Det.* **1997**, *34*, 156–168.
- 235 Sharma, M.K. Surfactants in Enhanced Petroleum Recovery Processes: An Overview in *Particle Technology and Surface Phenomena in Minerals and Petroleum Production*, Sharma, M.K.; Sharma, G.D. (Eds.), Plenum Press: New York, 1991, pp. 199–222.



- 236 Tadros, Th.F. *Adv. Colloid Interface Sci.* **1993**, *46*, 1–47.
- 237 Robb, I.D. (Ed.), *Microemulsions*; Plenum: New York, 1977.
- 238 Overbeek, J.T.G.; de Bruy, P.L.; Verhoeckx, F. *Microemulsions in Surfactants*; Tadros, Th. F. (Ed.), Academic Press: New York, 1984, pp. 111–131.
- 239 Tadros, Th. F. in *Surfactants in Solution*; Mittal, K.L.; Lindman, B. (Eds.), Plenum: New York, 1984, pp. 1501–1532.
- 240 Shah, D.O. (Ed.), *Macro- and Microemulsions: Theory and Applications*; American Chemical Society: Washington, 1985.
- 241 Robinson, B.H., *Nature*, **1986**, *320*, p. 309.
- 242 Friberg, S.E.; Bothorel, P. (Eds.), *Microemulsions: Structure and Dynamics*; CRC Press: Boca Raton, FL, 1987.
- 243 Leung, R.; Hou, M.J.; Shah, D.O. *Microemulsions: Formation, Structure, Properties, and Novel Applications in Surfactants in Chemical/Process Engineering*; Wasan, D.T.; Ginn, M.E.; Shah, D.O. (Eds.), Marcel Dekker: New York, 1988, pp. 315–367.
- 244 Kahlweit, M. *Ann. Rep. Prog. Chem, Sect. C*, **1999**, *95*, 89–115.
- 245 Kumar, P.; Mittal, K.L. (Eds.) *Handbook of Microemulsion Science and Technology*, Dekker: New York, 1999.
- 246 Takamura, K. *Can. J. Chem. Eng.* **1982**, *60*, 538–545.
- 247 Takamura, K.; Chow, R.S. *J. Can. Petrol. Technol.* **1983**, *22*, 22–30.
- 248 Schramm, L.L.; Smith, R.G.; Stone, J.A. *AOSTRA J. Research* **1984**, *1*, 5–14.
- 249 Schramm, L.L.; Smith, R.G. *Colloids Surfaces* **1985**, *14*, 67–85.
- 250 Schramm, L.L.; Smith, R.G. *Can. J. Chem. Eng.* **1987**, *65*, 799–811.
- 251 Schramm, L.L.; Smith, R.G. *AOSTRA J. Research* **1989**, *5*, 87–107.
- 252 Smith, R.G.; Schramm, L.L. *Fuel Proc. Technol.* **1989**, *23*, 215–231.
- 253 James, A.M. *Electrophoresis of Particles in Suspension in Surface and Colloid Science*, Vol. 11, Good, R.J.; Stromberg, R.R. (Eds.), Plenum: New York, 1979, pp. 121–186.
- 254 Masliyah, J.H. *Electrokinetic Transport Phenomena*, Alberta Oil Sands Technology and Research Authority: Edmonton, AB, 1994.
- 255 Babchin, A.J.; Chow, R.S.; Sawatzky, R.P. *Adv. Colloid Interface Sci.*, **1989**, *30*, 111–151.
- 256 Hunter, R.J. *Introduction to Modern Colloid Science*, Oxford University Press: Oxford, 1993.
- 257 Hunter, R.J. *Adv. Colloid Interface Sci.*, **1998**, *141*, 37–66.
- 258 Hunter, R.J. *Coll. Surf. A*, **2001**, *195*, 205–214.
- 259 Riddick, T.M. *Control of Stability Through Zeta Potential*, Zeta Meter Inc.: New York, 1968.
- 260 Okada, K.; Akagi, Y. *J. Chem. Eng. Japan* **1987**, *20*, 11–15.
- 261 Yoon, R-H.; Yordan, J.L. *J. Colloid Interface Sci.* **1986**, *113*, 430–438.
- 262 Whybrew, W.E.; Kinzer, G.D.; Gunn, R. *J. Geophys. Res.* **1952**, *57*, 459–471.
- 263 Usui, S.; Sasaki, H. *J. Colloid Interface Sci.* **1978**, *65*, 36–45.
- 264 O'Brien; White, L.R. *J. Chem. Soc. Faraday 2* **1978**, *74*, 1607–1626.
- 265 Schramm, L.L.; Smith, R.G. *Canadian Patent* 1,265,463, Feb. 6, 1990.
- 266 Somasundaran, P. *Interfacial Chemistry of Particulate Flotation in Advances in Interfacial Phenomena of Particulate/Solution/Gas Systems; Applications to Flotation Research*, Somasundaran, P.; Grieves, R.B. (Eds.), American Institute of Chemical Engineers: New York, 1975, pp. 1–15.
- 267 Schramm, L.L.; Kwak, J.C.T. *Soil Sci.*, **1984**, *137*, 1–6.
- 268 Morrison, I.D. *Colloids Surfaces A* **1993**, *71*, 1–37.
- 269 Speight, J.G. *Asphaltenes in Crude Oil and Bitumen: Structure and Dispersion in Suspensions, Fundamentals and Applications in the Petroleum Industry*, Schramm, L.L. (Ed.), American Chemical Society: Washington, 1996, pp. 377–401.
- 270 Shaw, R.C.; Schramm, L.L.; Czarnecki, J. *Suspensions in the Hot Water Flotation Process for Canadian Oil Sands in Suspensions, Fundamentals and Applications in the Petroleum Industry*, Schramm, L.L. (Ed.), American Chemical Society: Washington, 1996, pp. 639–675.
- 271 Li, H.; Wei, S.; Qing, C.; Yang, J. *J. Colloid Interface Sci.* **2003**, *258*, 40–44.
- 272 Gillispie, C.C. (Ed.) *Dictionary of Scientific Biography*, Volume VIII, Scribners: N.Y., 1974, pp. 473–479.
- 273 Overbeek, J. Th. G. *Colloids: A Fascinating Subject: Introductory Lecture in Colloidal Dispersions*; Goodwin, J.W. (Ed.), Royal Society of Chemistry: London, 1982, pp. 1–21.

- 274 Derjaguin, B. V.; Landau, L.D. *Acta Physicochem. URSS*, **1941**, *14*, 633–656.
- 275 Derjaguin, B.V.; Churaev, N.V.; Miller, V.M. *Surface Forces*, Consultants Bureau: New York, 1987.
- 276 E. J. Verwey and J. Th. G. Overbeek, *Theory of the Stability of Lyophobic Colloids*, Elsevier, Amsterdam, The Netherlands, 1948.
- 277 Williams, R.A.; Jia, X. *Chemistry & Industry (London)* **1992**, *11*, 409–412.
- 278 Volkov, A.G.; Deamer, D.W.; Tanelian, D.L.; Markin, V.S., *Progr. Surface Sci.*, **1996**, *53*, 1–134.
- 279 Morrison, I.D. *Colloids Surfaces*, **1993**, *71*, 1–37.
- 280 Bergeron, V., An Introduction to Forces and Structure in Individual Foam and Emulsion Films in *Foams and Emulsions*, Sadoc, J.F.; Rivier, N. (Eds.), NATO ASI Ser., Ser. E, Kluwer Academic Publishers: Boston, 1999, pp.45–72.
- 281 Pugh, R.J. *Adv. Colloid Interface Sci.*, **1996**, *64*, 67–142.
- 282 Correa, R.; Saramago, B. J. *Colloid Interface Sci.*, **2004**, *270*, 426–435.
- 283 Luckham, P.F.; de Costello, B.A. *Adv. Colloid Interface Sci.* **1993**, *44*, 183–240.
- 284 Horn, R. Surface Force Measurements in *Science, Technology, and Competitiveness*, Hixenbaugh, G.W. (Ed.), National Institute of Standards and Technology: Washington, 1996, pp. 96–104.
- 285 Schramm, L.L.; Kwak, J.C.T. *Clays Clay Minerals* **1980**, *28*, 67–69.
- 286 Sato, T.; Ruch, R. *Stabilization of Colloidal Dispersions by Polymer Adsorption*, Dekker: New York, 1980.
- 287 Tadros, Th. F. (Ed.), *The Effect of Polymers on Dispersion Properties*, Academic Press: London, 1982.
- 288 Lipatov, Y.S.; Sergeeva, L.M. *Adsorption of Polymers*, Halsted: New York, 1974.
- 289 Finch, C.A. (Ed.), *Chemistry and Technology of Water-Soluble Polymers*, Plenum Press: New York, 1983.
- 290 Vincent, B. The Stability of Solid/Liquid Dispersions in the Presence of Polymers in *Solid/Liquid Dispersions*, Tadros, Th. F. (Ed.), Academic Press: New York, 1987, pp. 147–162.
- 291 Walstra, P., Introduction to Aggregation Phenomena in *Food Colloids and Polymers: Stability and Mechanical Properties*, Dickinson, E.; Walstra, P. (Eds.), Royal Soc. Chem., London, 1993, pp. 3–15.
- 292 Gregory, J. Stability and Flocculation of Suspensions in *Processing of Solid-Liquid Suspensions*, Shamlou, P.A. (Ed.), Butterworth-Heinemann: Boston, 1993, pp. 59–92.
- 293 Damodaran, S. Protein-Stabilized Foams and Emulsions in *Food Proteins and Their Applications*, Damodaran, S.; Paraf, A. (Eds.), Dekker, New York, 1997, pp. 57–110.
- 294 Cavallo, J.L.; Chang, D.L. *Chem. Eng. Progr.* **1990**, *86*, 54–59.
- 295 Cairns, R.J.R.; Grist, D.M.; Neustadter, E.L. The effects of Crude Oil-Water Interfacial Properties on Water-Crude Oil Emulsion Stability in *Theory and Practice of Emulsion Technology*, Smith, A.L. (Ed.), Academic Press: New York, 1976; pp. 135–151.
- 296 Jones, T.J.; Neustadter, E.L.; Whittingham, K.P. *J. Can. Petrol. Technol.* **1978**, *17*, 100–108.
- 297 Binks, B.P. *Curr. Opinion Colloid Interface Sci.* **2002**, *7*, 21–41.
- 298 Arditty, S.; Schmitt, V.; Giermanska-Kahn, J.; Leal-Calderon, F. *Coll. Surf. A*, **2004**, *275*, 659–664.
- 299 Arditty, S.; Whitby, C.P.; Binks, B.P.; Schmitt, V.; Leal-Calderon, F. *Eur. Phys. J. E*, **2003**, *11*, 273–281.
- 300 Noble, P.F.; Cayre, O.J.; Alargova, R.G.; Velev, O.D.; Paunov, V.N. *J. Am. Chem. Soc.* **2004**, *126*, 8092–8093.
- 301 Wasan, D.T.; Koczko, K.; Nikolov, A.D. Mechanisms of Aqueous Foam Stability and Antifoaming Action With and Without Oil: A Thin Film Approach in *Foams, Fundamentals and Applications in the Petroleum Industry*, Schramm, L.L. (Ed.), American Chemical Society: Washington, DC, 1994, pp. 47–114.
- 302 Prins, A.; van Kalsbeek, H.K.A.I. *Curr. Opinion Colloid Interface Sci.* **1998**, *3*, 639.
- 303 Schramm, L.L.; Wassmuth, F. Foams: Basic Principles in *Foams, Fundamentals and Applications in the Petroleum Industry*, Schramm, L.L. (Ed.), American Chemical Society: Washington, DC, 1994, pp. 3–45.
- 304 Huang, D.D.W.; Nikolov, A.; Wasan, D.T. *Langmuir*, **1986**, *2*, 672–677.
- 305 Schramm, L.L.; Green, W.H.F. *Colloids & Surfaces*, **1995**, *94*, 13–28.
- 306 Schramm, L.L.; Mannhardt, K.; Novosad, J.J. Selection of Oil-Tolerant Foams for Hydrocarbon Miscible Gas Flooding in *Proceedings, 14th. International Workshop and Symposium*,

- International Energy Agency Collaborative Project on Enhanced Oil Recovery*, Rieder, E. (Ed.), OMV Energie, Vienna, Austria, 1993, paper 18.
- 307 Schramm, L.L.; Novosad, J.J. *J. Petrol. Sci. Eng.* **1992**, *7*, 77–90.
- 308 Mannhardt, K.; Novosad, J.J.; Schramm, L.L. *J. Petrol. Sci. Eng.*, **1996**, *14*, 183–195.
- 309 Schramm, L.L.; Mannhardt, K. *J. Petrol. Sci. Eng.*, **1996**, *15*, 101–113.
- 310 Novosad, J.J.; Ionescu, E.F. Foam Forming Surfactants for Beaverhill Lake Carbonates and Gilwood Sands Reservoirs in *Proc., CIM Annual Technical Meeting*, Canadian Inst. Mining, Metallurgical and Petroleum Engineers: Calgary, AB, 1987, paper CIM 87-38-80.
- 311 Wassmuth, F.; Schramm, L.L.; Mannhardt, K.; Hodgins, L. Scale-Up Evaluations and Simulations of Mobility Control Foams for Improved Oil Recovery in *Surfactants, Fundamentals and Applications in the Petroleum Industry*, Schramm, L.L. (Ed.), Cambridge University Press: Cambridge, 2000, pp. 251–292.
- 312 Stumm, W.; Morgan, J.J. *Aquatic Chemistry*, 2nd ed., Wiley: New York, 1981.
- 313 Kralchevsky, P.A.; Danov, K.D.; Denkov, N.D. Chemical physics of colloid systems and interfaces in *Handbook of Surface and Colloid Chemistry*, Birdi, K.S. (Ed.), CRC Press: Boca Raton, 1997, pp. 333–494.
- 314 Matijević, E. in *Twenty Years of Colloid and Surface Chemistry*, Mysels, K.J.; Samour, C.M.; Hollister, J.H. (Eds.), American Chemical Society: Washington, D.C., 1973, pp. 283.
- 315 Stumm, W.; Morgan, J.J. *Aquatic Chemistry*. Wiley-Interscience: New York, 1970.
- 316 Alince, B.; Van de Ven, T.G.M. *J. Colloid Interface Sci.* **1993**, *155*, 465–470.
- 317 Kostoglou, M.; Karabelas, A.J. *J. Colloid Interface Sci.*, **1991**, *142*, 297–301.
- 318 Gregory, J. *Crit. Rev. Environ. Control* **1989**, *19*, 185–230.
- 319 Overbeek, J.Th.G. Electrokinetic Phenomena in *Colloid Science*, Vol. 1, Kruyt, H.R. (Ed.), Elsevier: Amsterdam, 1952, pp. 194–244.
- 320 Grim, R.E. *Clay Mineralogy*, 2<sup>nd</sup> ed., McGraw-Hill: New York, 1968.
- 321 Schramm, L.L.; Kwak, J.C.T. *Clays Clay Minerals* **1982**, *30*, 40–48.
- 322 Schramm, L.L.; Kwak, J.C.T. *Colloids and Surfaces* **1982**, *3*, 43–60.
- 323 Schramm, L.L.; Kwak, J.C.T. *Can. J. Chem.* **1982**, *60*, 486–494.
- 324 Capes, C.E.; McIlhinney, A.E.; Sirianni, A.F. Agglomeration from Liquid Suspension – Research and Applications in *Agglomeration* 77, Sastry, K.V.S. (Ed.), Am. Inst. Mining, Metall. Petrol. Engineers: New York, 1977, pp. 910–930.
- 325 Sirianni, A.F.; Capes, C.E.; Puddington, I.E. *Can. J. Chem. Eng.* **1969**, *47*, 166–170.
- 326 Sparks, B.D.; Farnand, J.R.; Capes, C.E. *J. Separ. Proc. Technol.* **1982**, *3*, 1–15.
- 327 Kerner, H.T. *Foam Control Agents*; Noyes Data Corp.: Park Ridge, NJ, 1976.
- 328 Kuhlman, M.I. *J. Petrol. Technol.* **1990**, *July*, 902–908.
- 329 Holt, T.; Kristiansen, T.S. Improved Sweep Efficiency During Gas Injection – Mobility Control. in *Proc. SPOR Seminar*, Norwegian Petroleum Directorate: Stavanger, Norway, 1990, pp. 59–77.
- 330 Raterman, K.T. An Investigation of Oil Destabilization of Nitrogen Foams in Porous Media in *Proceedings, 64th. Ann. Tech. Conference*, Society of Petroleum Engineers: Richardson, TX, 1989, paper SPE 19692.
- 331 Manlowe, D.J.; Radke, C.J. *SPE Reservoir Eng.* **1990**, *5*, 495–502.
- 332 Schramm, L.L.; Novosad, J.J. *Colloids and Surfaces* **1990**, *46*, 21–43.
- 333 Schramm, L.L.; Turta, A.; Novosad, J.J. *SPE Reservoir Eng.* **1993**, *8*, 201–206.
- 334 Manlowe, D.J.; Radke, C.J. *SPE Reservoir Eng.* **1990**, *5*, 495–502.
- 335 Hanssen, J.E.; Dalland, M. Foam for Effective Gas Blockage in the Presence of Crude Oil in *Proceedings, SPE/DOE 7th. EOR Symposium*, Society of Petroleum Engineers: Richardson, TX, 1990, paper SPE/DOE 20193.
- 336 Raterman, K.T. An Investigation of Oil Destabilization of Nitrogen Foams in Porous Media in *Proceedings, 64th. Ann. Tech. Conference*, Society of Petroleum Engineers: Richardson, TX, 1989, paper SPE 19692.
- 337 Kristiansen, T.S.; Holt, T. Properties of Flowing Foam in Porous Media Containing Oil in *Proc., 12<sup>th</sup> International Workshop and Symposium, IEA Collaborative Project on EOR*, Atomic Energy Agency: Winfrith, UK, 1991.
- 338 Mannhardt, K.; Novosad, J.; Schramm, L.L. Foam/Oil Interactions at Reservoir Conditions in *Proceedings, SPE/DOE Improved Oil Recovery Symposium*, Society of Petroleum

- Engineers: Richardson, TX; 1998, paper SPE 39681.
- 339 Maini, B. Laboratory Evaluation of Foaming Agents for High Temperature Applications – III. Effect of Residual Oil on Mobility Reduction Performance in *Proc. 37th Ann. Tech. Meeting CIM*, The Petroleum Society: Calgary, AB, 1986, paper CIM 86-37-01.
- 340 Rendall, W.A.; Ayasse, C.; Novosad, J.J. *U.S. Patent* 5,074,358, Dec. 24, 1991.
- 341 Schramm, L.L.; Ayasse, C.; Mannhardt, K.; Novosad, J.J. *U.S. Patent* 5,060,727, Oct. 29, 1991.
- 342 Nikolov, A.D.; Wasan, D.T.; Huang, D.W.; Edwards, D.A. The Effect of Oil on Foam Stability: Mechanisms and Implications for Oil Displacement by Foam in Porous Media in *Proc. 61st Ann. Tech. Conf. SPE*, Society of Petroleum Engineers: Richardson, TX, 1986, paper SPE 15443.
- 343 Schramm, L.L.; Mannhardt, K. *J. Petrol. Sci. & Eng.*, **1996**, 15, 101–113.
- 344 Friedmann, F.; Jensen, J.A. Some Factors Influencing the Formation and Propagation of Foams in Porous Media in *Proc. 56th. SPE Calif. Regional Meeting*, Society of Petroleum Engineers: Richardson, TX, 1986, paper SPE 15087.
- 345 Olsen, D.K.; Sarathi, P.S. (Eds.), *Proceedings, Field Application of Foams for Oil Production Symposium*, U.S. Department of Energy, Bartlesville, OK, 1993.
- 346 Law, D.H.; Yang, Z.-M.; Stone, T.W. *SPE Res. Eng.* **1992**, 7, 228–236.
- 347 Schramm, L.L.; Isaacs, E.; Singhal, A.K.; Hawkins, B.; Schulmeister, B.; Wassmuth, F.; Randall, L.; Turta, A.; Zhou, J.; Tremblay, B.; Lilloco, D.; Wagg, B. Technology development for conventional petroleum reservoirs. *J. Can. Petrol. Technol.*, **2000**, *Canadian Advantage 2000 Special Issue*, 31–46.
- 348 Schramm, L.L.; Ayasse, C.; Mannhardt, K.; Novosad, J.J. *U.S. Patents* 5,060,727, Oct. 29, 1991, and 5,301,539, April 12, 1994.
- 349 Schramm, G. *Optimization of Rotovisco Tests*, Gebrüder Haake GmbH: Dieselstrasse, Germany, 1981.
- 350 Schramm, L.L. *J. Can. Petrol. Technol.*, **1989**, 28, 73–80.
- 351 van de Ven, Th.G.M. *Colloidal Hydrodynamics*, Academic Press: London, 1989.
- 352 Mill, C. C. (Ed.) *Rheology of Disperse Systems*, Pergamon Press: Elmsford, N.Y., 1959.
- 353 Fredrickson, A.G. *Principles and Applications of Rheology*, Prentice-Hall: Englewood Cliffs, N.J., 1964.
- 354 Walters, K. *Rheometry: Industrial Applications*, Research Studies Press: New York, 1980.
- 355 Whorlow, R.W. *Rheological Techniques*, Ellis Horwood: Chichester, England, 1980.
- 356 Van Wazer, J.R.; Lyons, J.W.; Kim, K.Y.; Colwell, R.E. *Viscosity and Flow Measurement*, Wiley: New York, 1963.
- 357 Moore, F. *Rheology of Ceramic Systems*, MacLaren and Sons: London, 1965.
- 358 “Laboratory Equipment for Viscosity and Petroleum Testing” Catalog, Cannon Instrument Co.: State College, PA, 1985.
- 359 Jones, T.G.J.; Hughes, T.L., Drilling Fluid Suspensions in *Suspensions, Fundamentals and Applications in the Petroleum Industry*, Schramm, L.L. (Ed.), American Chemical Society: Washington, 1996, pp. 463–564.
- 360 Johnsen, E.E.; Rønningsen, H.P. *J. Petrol. Sci. Eng.* **2003**, 38, 23–36.
- 361 *Standard Test Method for Viscosity by Dip-Type Viscosity Cups*, ASTM Designation D 4212-93, American Society for Testing and Materials: Philadelphia, PA, January, 1994.
- 362 *Standard Test Method for Viscosity by Ford Viscosity Cup*, ASTM Designation D 1200-94, American Society for Testing and Materials: Philadelphia, PA, October, 1994.
- 363 *Standard Practice for Conversion of Kinematic Viscosity to Saybolt Universal Viscosity or Saybolt Furol Viscosity*, ASTM Designation D 2163-93, American Society for Testing and Materials: Philadelphia, PA, July, 1993.
- 364 Bailey, W.J.; Weir, I.S., *J. Petrol. Sci. Eng.*, **1998**, 21, 1–13.
- 365 *Nametre Direct Readout Viscometer Brochure*, Nametre Co.: Edison, N.J., 1972.
- 366 Fitzgerald, J.V. and Matusik, F.J., “Applications of a vibratory viscometer” *American Laboratory*, June, 1976.
- 367 Fitzgerald, J.V., Matusik, F.J., and Scarna, P.C., “Viscometer for energy saving” *Measurements and Control*, April, 1980.
- 368 Ferry, J.D. *Measurements and Control*, **1977**, Sept.–Oct., 89–91.
- 369 Oppliger, H.R.; Matusik, F.J.; Fitzgerald, J.V., *Control Engineering*, **1975**, July, 39–40.
- 370 Schramm, L.L., *Canadian Patent* 1,232,854, Feb. 16, 1988.
- 371 Gillies, G.; Prestidge, C.A. *Adv. Colloid Interface Sci.* **2004**, 108/109, 197–205.

- 372 Schramm, L.L., Suspensions: Basic principles: In *Suspensions: Fundamentals and Applications in the Petroleum Industry*, Schramm, L.L. (Ed.), American Chemical Society, Washington, pp. 3–44, 1996.
- 373 Etchells, A.W. Slurry-Handling Problems in the Process Industries in *Processing of Solid-Liquid Suspensions*, Shamlou, P.A. (Ed.), Butterworth-Heinemann: Boston, 1993, pp. 310–322.
- 374 Ostwald, W., *Kolloid Z.*, **1925**, *36*, 99–117.
- 375 de Waele, A., *J. Oil Color Chem. Assoc.* **1923**, *6*, 33–88.
- 376 Liu, S.; Masliyah, J. Rheology of Suspensions in *Suspensions, Fundamentals and Applications in the Petroleum Industry*, Schramm, L.L. (Ed.), American Chemical Society: Washington, 1996, pp 107–176.
- 377 Melrose, J.C.; Savins, J.G.; Foster, W.R.; Parish, E.A.A., *Proc. 32<sup>nd</sup> Ann. Mtg. of SPE; Society of Petroleum Engineers*: Richardson, TX, 1957, paper SPE 876-G.
- 378 Herschel, W.H.; Bulkley, R., *Proc. 29<sup>th</sup> Ann. Mtg. of ASTM; American Society for Testing and Materials*: Philadelphia, PA, **1926**, *26*, 621–630.
- 379 Robertson, R.E.; Stiff, H.H., *Soc. Petrol. Eng. J.* **1976**, *16*, 31–36.
- 380 Jones, T.G.; Hughes, T.L. Drilling Fluid Suspensions Drilling Fluid Suspensions in *Suspensions, Fundamentals and Applications in the Petroleum Industry*, Schramm, L.L. (Ed.), American Chemical Society: Washington, 1996, pp. 463–564.
- 381 Skelland, A.H.P., *Non-Newtonian Flow and Heat Transfer*, Wiley: New York, 1967.
- 382 Pal, R.; Yan, Y.; Masliyah, J. Rheology of Emulsions in *Emulsions, Fundamentals and Applications in the Petroleum Industry*, Schramm, L.L. (Ed.), American Chemical Society: Washington, 1992, pp 131–170.
- 383 Contraves, *Measurement of Rheological Properties*, Bulletin T 990 e-8509 CZ, Contraves AG Zürich: Zürich, Switzerland, 1985.
- 384 Andrade, E.N.da C. *Nature*, **1930**, *125*, 309–310 and 582–584.
- 385 Khan, M.A.B.; Mehrotra, A.K.; Svrcek, W.Y., *J. Can. Petrol. Technol.*, **1984**, *23*, 47–53.
- 386 Melsheimer, J.; Langner, K. *Colloid Polymer Sci.* **1980**, *258*, 160–167.
- 387 Schramm, L.L.; Kwak, J.C.T., *J. Can. Petrol. Technol.*, **1988**, *27*, 26–35.
- 388 *Standard Practice for Calculating Viscosity Index from Kinematic Viscosity at 40 and 100 C*. ASTM Designation D 2270-93, American Society for Testing and Materials, May, 1993.
- 389 Booser, E.R. Lubrication and Lubricants in *Kirk-Othmer Encyclopedia of Chemical Technology*, 3<sup>rd</sup> ed., Vol. 14, Interscience: New York, 1981, pp. 477–526.
- 390 Schramm, L.L. *J. Can. Petrol. Technol.* **1989**, *28*, 73–80.
- 391 Brinkman, H.C. *J. Chem. Phys.* **1952**, *20*, 571–572.
- 392 Roscoe, R. *Br. J. Appl. Physics*, **1952**, *3*, 267–269.
- 393 Mooney, M. *J. Colloid Sci.*, **1951**, *6*, 162–170.
- 394 Krieger, I.M.; Dougherty, T.J. *Trans. Soc. Rheol.*, **1959**, *3*, 137–152.
- 395 Taylor, G.I. *Proc. Royal Society Series A*, **1932**, *138*, 41–48.
- 396 Richardson, E.G. *Kolloid-Z.*, **1933**, *656*, 32.
- 397 Broughton, J.; Squires, L. *J. Phys. Chem.*, **1938**, *42*, 253–263.
- 398 Hatschek, E. *Kolloid-Z.*, **1911**, *8*, 34–39.
- 399 Sibley, J.O. *J. Chem. Soc. Faraday Trans.*, **1931**, *27*, 161.
- 400 Eilers, H. *Kolloid-Z.*, **1943**, *102*, 154–169.
- 401 Pal, R.; Rhodes, E. *J. Rheol.*, **1989**, *33*, 1021–1045.
- 402 Krynke, K.; Sk, J.P. *Coll. Surf. A*, **2004**, *245*, 81–92.
- 403 Aubert, J.H.; Kraynik, A.M.; Rand, P.B. *Sci. Amer.* **1986**, *254*, 74–82.
- 404 Blair, C.M. *Chem. Ind.* **1960**, *5*, 538.
- 405 Reisberg, J.; Doscher, T.M. *Prod. Mon.* **1956**, *11*, 43.
- 406 Jones, T.J. Neustadter, E.L. Whittingham, K.P. *J. Can. Petrol. Technol.* **1978**, *17*, 100–108.
- 407 Joly, M. Surface Viscosity in *Recent Progress in Surface Science*, Danielli, J.F.; Pankhurst, K.G.A.; Riddiford, A.C. (Eds.), Academic Press, New York, 1964, pp. 1–50.
- 408 Malhotra, A.K.; Wasan, D.T. Interfacial Rheological Properties of Adsorbed Surfactant Films with Applications to Emulsion and Foam Stability in *Thin Liquid Films*, Ivanov, I.B. (Ed.), Dekker: New York, 1988, pp. 829–890.
- 409 Jones, T.J.; Neustadter, E.L.; Whittingham, K.P. *J. Can. Petrol. Technol.* **1978**, *17*, 100–108.
- 410 Miller, R.; Wüstneck, R.; Krägel, J.; Kretzschmar, G. *Colloids and Surfaces*, **1996**, *111*, 75–118.

- 411 Clunie, J.S.; Goodman, J.F.; Ingram, B.T. Thin Liquid Films in *Surface and Colloid Science*, Vol. 3, Matijevic, E. (Ed.), Wiley: New York, 1971, pp. 167–239.
- 412 Xu, W.; Nikolov, A.; Wasan, D.T., Gonsalves, A.; Borwankar, R.P. *Coll. Surf. A*, **2003**, *214*, 13–21.
- 413 Blasius, H.F. *Forschungsarbeiten Gebiete Ingenieurwesens*, **1913**, 131.
- 414 Drew, T.B., Koo, E.C., McAdams, W.H. *Trans. Am. Inst. Chem. Eng.*, **1932**, *28*, 56.
- 415 Forbes, C.D.; Lowe, G.D.O. Blood Viscosity Measurement in Physics in *Medicine and Biology Encyclopedia*, Vol. 1, McAinsh, T.F. (Ed.), Pergamon: New York, 1986, pp. 105–107.
- 416 Sing, K.S.W. *Coll. Surf. A*, **2004**, *241*, 3–7.
- 417 Heavyside, J. Measurement of Relative Permeability in *Interfacial Phenomena in Petroleum Recovery*, Morrow, N.R. (Ed.), Dekker: New York, 1991, pp. 377–412.
- 418 Orr, F.M.; Pande, K.K.; White, C.D. Relative Permeability in Heterogeneous Porous Media in *Interfacial Phenomena in Petroleum Recovery*, Morrow, N.R. (Ed.), Dekker: New York, 1991, pp. 413–440.
- 419 Liu, S.; Masliyah, J.H. Principles of Single-Phase Flow Through Porous Media in *Suspensions, Fundamentals and Applications in the Petroleum Industry*, Schramm, L.L. (Ed.), American Chemical Society: Washington, 1996, pp. 227–286.
- 420 Wilhite, G.P. *Waterflooding*, Society of Petroleum Engineers: Richardson, TX, 1986.
- 421 Shah, D.O. (Ed.), *Surface Phenomena in Enhanced Oil Recovery*, Plenum Press: New York, 1981.
- 422 Kovscek, A.R.; Radke, C.J. Fundamentals of Foam Transport in Porous Media in *Foams, Fundamentals and Applications in the Petroleum Industry*, Schramm, L.L. (Ed.), American Chemical Society: Washington, 1996, pp. 115–163.
- 423 Chambers, K.T.; Radke, C.J. Capillary Phenomena in Foam Flow Through Porous Media in *Interfacial Phenomena in Petroleum Recovery*, Morrow, N.R. (Ed.), Dekker: New York, 1991, pp. 191–256.
- 424 Nasr-El-Din, H.A. Permeability Decline Due to Flow of Dilute Suspensions Through Porous Media in *Suspensions, Fundamentals and Applications in the Petroleum Industry*, Schramm, L.L. (Ed.), American Chemical Society: Washington, 1996, pp. 289–319.
- 425 Maini, B.; Wassmuth, F.; Schramm, L.L. Fines Migration in Petroleum Reservoirs in *Suspensions, Fundamentals and Applications in the Petroleum Industry*, Schramm, L.L. (Ed.), American Chemical Society: Washington, 1996, pp. 321–375.
- 426 Schramm, L.L. Colloids in *Kirk-Othmer Encyclopedia of Chemical Technology*, Online edition, posted July 18, 2003, Wiley: New York, 2003.
- 427 Breuer, M.M. Cosmetic Emulsions in *Encyclopedia of Emulsion Technology*, Vol. 3, Becher, P. (Ed.), Marcel Dekker: New York, 1985, p. 386.
- 428 American Chemical Society, *Physical Functions of Hydrocolloids*, American Chemical Society: Washington, 1960.
- 429 Miner, P.E. Emulsion Rheology: Creams and Lotions in *Rheological Properties of Cosmetics and Toiletries*, Laba, D. (Ed.), Marcel Dekker: New York, 1993, pp. 313–370.
- 430 Goff, H.D. Ice Cream in *Lipid Technologies and Applications*, Gunstone, F.D.; Padley, F.B. (Eds.), Dekker: New York, 1997, pp. 329–354.
- 431 Forster, T.; Jackwerth, B.; Pittermann, W.; von Tybinskin, W.; Schmitt, M. *Cosmetics and Toiletries*, **1997**, *112*, 73–82.
- 432 Förster, T. Principles of Emulsion Formation in *Surfactants in Cosmetics*, Rieger, M.M.; Rhein, L.D. (Eds.), Marcel Dekker: New York, 1997, 105–125.
- 433 Mason, T.G. *Curr. Opinion Coll. Interface Sci.*, **1999**, *4*, 231–238.
- 434 Vander Kloet, J.; Schramm, L.L. *J. Surfactants Deterg.*, **2002**, *5*, 19–24.
- 435 Lissant, K.J., *Emulsions and Emulsion Technology*, Marcel Dekker: New York, 1974.
- 436 Chen, H.H.; Ruckenstein, E. *J. Colloid Interface Sci.*, **1991**, *145*, 260–269.
- 437 Cameron, N.R.; Sherrington, D.C. *J. Chem. Soc. Faraday Trans.*, **1996**, *92*, 1543–1547.
- 438 Aronson, M.P.; Petko, M.F. *J. Colloid Interface Sci.*, **1993**, *159*, 134–149.
- 439 Kirikou, M.; Sherman, P. *J. Colloid Interface Sci.*, **1979**, *71*, 51–54.
- 440 Rieger, M.M. *Cosmetics and Toiletries* **1991**, *106*, 59–69.
- 441 Bibette, J.; Leal Calderon, F.; Poulin, P. *Rep. Prog. Phys.*, **1999**, *62*, 969–1033.
- 442 Taelman, M. C.; Loll, P. Multiple Emulsions in Cosmetics in *Proc. Cosmet. Conf.*, Everberg: Belgium, 1994, pp. 213–233.
- 443 Huang, D.D.W.; Nikolov, A.; Wasan, D.T. *Langmuir* **1986**, *2*, 672–677.

- 444 Hem, J.D. *Study and Interpretation of the Chemical Characteristics of Natural Water*, 2<sup>nd</sup> Ed., U.S. Geological Survey: Washington, 1970.
- 445 Schramm, L.L.; Kwak, J.C.T. *Clays Clay Minerals*, 1980, 28, 67–69.
- 446 Riegel, E.R. *Chemical Machinery*, Reinhold: New York, 1944.
- 447 Wills, B.A. *Mineral Processing Technology*, 6<sup>th</sup> ed., Butterworth-Heinemann: Oxford, July 1997.
- 448 Fallenius, K. *Acta Polytechnica Scand.*, 1977, 138, 1–30.
- 449 Nelson, R.D. Powders, Handling, Dispersion of Powders in Liquids in *Kirk–Othmer Encyclopedia of Chemical Technology*, Online edition, posted December 4, 2000, Wiley: New York, 1996.
- 450 Jiao, J.; Burgess, D.J. *J. Colloid Interface Sci.* 2003, 264, 509–516.
- 451 Jones, T.J.; Neustadter, E.L.; Whittingham, K.P. *J. Can. Petrol. Technol.* 1978, 17, 100–108.
- 452 Grace, R. Commercial Emulsion Breaking in *Emulsions, Fundamentals and Applications in the Petroleum Industry*; Schramm, L.L. (Ed.), American Chemical Society: Washington, DC, 1992, pp. 313–339.
- 453 Schramm, L.L.; Hackman, L.P., unpublished results.
- 454 Miyagi, A.; Nakajima, M. *J. Surf. Deterg.* 2003, 6, 373–378.
- 455 Tambe, D.; Paulis, J.; Sharma, M.M. *J. Colloid Interface Sci.*, 1995, 171, 463–469.
- 456 Fuestel, M. *Oil Gas European Magazine*, 1995, 21, 42.
- 457 Taylor, S. *Chemistry and Industry*, 1992, 20, 770–775.
- 458 Bessler, D.U. *Demulsification of Enhanced Oil Recovery Produced Fluids*, Petrolite Corporation, 1983.
- 459 Mukherjee, S.; Kushnick, A.P. Effects of Demulsifiers on Interfacial Properties Governing Crude Oil Demulsification in *Oil-Field Chemistry, Enhanced Recovery and Production Stimulation*, Borchardt, J.K.; Yen, T.F. (Eds.), American Chemical Society: Washington, DC, 1989, pp. 364–375.
- 460 Zaki, N.; Al-Sabagh, L. *Tenside Surf. Deter.* 1997, 34, 12–17.
- 461 Smith, V.H.; Arnold, K.E. Crude Oil Emulsions in *Petroleum Engineering Handbook*, Bradley, H.B. (Ed.), Society of Petroleum Engineers: Richardson, TX, 1992, pp. 19–1 to 19–34.
- 462 Staiss, F.; Bohm, R.; Kupfer, R. *SPE Prod. Eng.* 1991, 6, 334–341.
- 463 Berger, P.D.; Hsu, C.; Arendell, J.P. Designing and Selecting Demulsifiers for Optimum Field Performance on the Basis of Production Fluid Characteristics in *Proc. Ann. Tech. Conf. SPE*, Society of Petroleum Engineers: Richardson, TX, 1987, SPE paper 16285.
- 464 Monson, L.T.; Stenzel, R.W. The Technology of Resolving Petroleum Emulsions in *Colloid Chemistry*, Vol VI, Alexander, J. (Ed.), Reinhold: New York, 1946, pp. 535–552.
- 465 Van Os, N.M.; Haak, J.R.; Rupert, L.A.M. *Physico-Chemical Properties of Selected Anionic, Cationic and Nonionic Surfactants*, Elsevier: New York, 1993.
- 466 Manek, M.B., Asphaltene Dispersants as Demulsification Aids in *Proc. SPE International Symposium on Oilfield Chemistry*, Society of Petroleum Engineers: Richardson, TX, 1995, SPE paper 28972.
- 467 Zana, R. *Surfactant Solutions. New Methods of Investigations*, Dekker: New York, 1986.
- 468 Scoular, R.J.; Kurucz, L.; Verkoczy, B.; Mikula, R.J.; MacConnachie, C.A.; Payette, C.; Munoz, V.A. *Emulsions Research*, Saskatchewan Research Council: Saskatoon, SK, Publication P-110-186-C-91, March, 1991.
- 469 MacConnachie, C.A.; Mikula, R.J.; Kurucz, L.; Scoular, R.J. Correlation of Demulsifier Chemistry and Demulsifier Performance, *Proc. 5th Saskatchewan Petroleum Conference*, Petroleum Society of CIM: Regina, SK, 1993, paper 39.
- 470 Lissant, K.J. *Demulsification, Industrial Applications*; Dekker: New York, NY, 1983.
- 471 Bessler, D.U., *Demulsification of Enhanced Oil Recovery Produced Fluids*, Petrolite Corporation: St. Louis, 1983.
- 472 Tambe, D.; Paulis, J.; Sharma, M.M., *J. Colloid Interface Science*, 1995, 171, 463–469.
- 473 Fuestel, M., *Oil Gas European Magazine*, 1995, 21, 42–45.
- 474 Taylor, S. *Chemistry and Industry*, 1992, 20, 770–773.
- 475 Sonntag, H.; Strenge, K. *Coagulation and Stability of Disperse Systems*, Halsted Press: New York, 1972.
- 476 Gennaro, A.R. (Ed.), *Remington's Pharmaceutical Sciences*, 17<sup>th</sup> ed., Mack Publishing Co.: Easton, PA, 1985.

- 477 Zaki, N.N.; Abdel-Raouf, M.E.; Abdel-Azim, *Monatshfte für Chemie (Chemical Monthly Austria)*, 1996, 127, 1239–1245.
- 478 Amaravathi, M.; Pandey, B.P. *Res. Ind.* 1991, 36, 198.
- 479 Berger, P.D.; Hsu, C.; Arendell, J.P. Designing and Selecting Demulsifiers for Optimum Field Performance Based on Production Fluid Characteristics in *Proc. SPE Ann. Tech. Conference*, Society of Petroleum Engineers: Richardson, TX, 1987, SPE paper 16285.
- 480 Jones, T.J.; Neustadter, E.L.; Whittingham, K.P. *J. Can. Petrol. Technol.* 1978, 17, 100–108.
- 481 Zaidi, A.; Constable, T. *Produced Water Treatment Design Manual*; Wastewater Technology Centre: Burlington, ON, 1994.
- 482 Scoular, R.J. Breaking Wellhead Emulsions in *Supplementary Notes for Petroleum Emulsions and Applied Emulsion Technology*; Schramm, L.L. (Ed.), Petroleum Recovery Institute: Calgary, AB, 1992, 17 pp..
- 483 Schrickel, J. Defoaming Agents for Water-Based Coatings: Influences of the Defoamer and Influences on the Defoamer in *Advances in Additives for Water-Based Coatings*, Davison, G.; Skuse, D.R., Spec. Publ. 243, Royal Soc. Chem.: London, 1999, pp. 29–47.
- 484 Garrett, P.R. (Ed.), *Defoaming Theory and Industrial Applications*, Marcel Dekker: New York, 1993.
- 485 Thomas, T.R. and Wilkes, T.M., The Use of Surfactants in Lightweight Drilling Fluids in *Surfactants, Fundamentals and Applications in the Petroleum Industry*, Schramm, L.L. (Ed.), Cambridge University Press, Cambridge, UK, 2000, pp. 295–327.
- 486 Zotto, A.A. Antifoams and Release Agents in *Food Additive User's Handbook*, Smith, J. (Ed.), Blackie: Glasgow, 1991, pp. 236–241.
- 487 Binks, B.P.; Fletcher, P.D.I.; Haynes, M.D. *Coll. Surf. A*, 2003, 216, 1–8.
- 488 Kitchener, J.A. Foams and Free Liquid Films in *Recent Progress in Surface Science*, Vol. 1, Danielli, J.F.; Pankhurst, K.G.A.; Riddiford, A.C. (Eds.), Academic Press: New York, 1964, pp. 51–93.
- 489 Schrickel, J. Defoaming Agents for Water-Based Coatings: Influences of the Defoamer and Influences on the Defoamer, in *Advances in Additives for Water-based Coatings*, Davison, G.; Skuse, D.R. Royal Society of Chemistry: London, 1999, pp. 29–47.
- 490 Ferch, H.; Leonhardt, W. Foam Control in Detergent Products in *Defoaming Theory and Industrial Applications*, Garrett, P.R. (Ed.), Marcel Dekker: New York, 1993, pp. 221–268.
- 491 'It's not just oil' *Consumer Reports* 1996, 61, p. 14.
- 492 Dickinson, E. (Ed.), *Food Emulsions and Foams*, Royal Society of Chemistry: London, 1987.
- 493 Sumner, C.G. *Clayton's The Theory of Emulsions and Their Technical Treatment*, 5th ed., Blakiston: New York, 1954.
- 494 Roy, D., Valsaraj, K.T., Tamayo, A. *Sep. Sci. Technol.* 1992, 27, 1555–1568.
- 495 Roy, D., Valsaraj, K.T., Constant, W.D., Darji, M. *J. Hazardous Mat.* 1994, 38, 127–144.
- 496 Roy, D., Kommalapati, R.R., Valsaraj, K.T., Constant, W.D. *Water Res.* 1995, 29, 589–595.
- 497 Roy, D., Kongara, S., Valsaraj, K.T. *J. Hazardous Mat.* 1995, 42, 247–263.
- 498 Enzien, M.V., Michelsen, D.L., Peters, R.W., Bouillard, J.X., Frank, J.R. Enhanced In Situ Bioremediation Using Foams and Oil Aphrons in *Proceedings, 3<sup>rd</sup> Int. Symp. In-Situ and On-Site Reclamation*, San Diego, CA, 1995, pp. 503–509.
- 499 Mirzadzanzade, A.K., Ametov, I.M., Bogopol'sky, A.O., Kristensen, R., Anziryayev, U.N., Klyshnikov, S.V., Mamedzade, A.M., Salatov, T.S. in *Proceedings, 7<sup>th</sup> European IOR Symp.*, Moscow, Russia, 1993, pp. 469–473.
- 500 Mirzadzanzade, A.K., Ametov, I.M., Bokserman, A.A., Filippov, V.P. in *Proceedings, 7<sup>th</sup> European IOR Symp.*, Moscow, Russia, 1993, pp. 27–29.
- 501 Jastrzebski, Z. D. *The Nature and Properties of Engineering Materials*, 2<sup>nd</sup> ed., Wiley: New York, 1977.
- 502 Gordon, J.E. *The New Science of Strong Materials*, 2<sup>nd</sup> ed., Princeton University Press: Princeton, N.J., 1976.
- 503 Guy, A.G. *Essentials of Materials Science*, McGraw-Hill: New York, 1976.
- 504 Martell, A.E. *Pure Appl. Chem.* 1975, 44, 81–113.
- 505 Mackenzie, F.T.; Wollast, R. Sedimentary Cycling Models of Global Processes in *The Sea*, Vol. 6, Goldberg, E.D. (Ed.), Wiley-Interscience: New York, 1977, pp. 739–788.
- 506 Maddin, C.M. Marine Toxicity and Persistence of Surfactants Used in the Petroleum Producing Industry in *Proc. Internat. Conf. Health, Safety and Environment*, Society of Pe-



- troleum Engineers: Richardson, TX, 1991, SPE paper 23354.
- 507 Leduc, G.; Ruber, H.; Webb, M. *Toxicity of Mine Flotation Reagents*, Report ALUR 1972-73, Dept. Indian Affairs and Northern Development: Ottawa, 1973, 10 pp.
- 508 Wei, J.; Russel, T.W.F.; Swartzlander, M.W. *The Structure of the Chemical Processing Industries*, McGraw-Hill: New York, 1979.
- 509 Freeman, M.P.; Fitzpatrick, J.A. (Eds.), *Physical Separations*, Engineering Foundation: New York, 1980.
- 510 Rubin, A.J. (Ed.), *Chemistry of Wastewater Technology*, Ann Arbor Science: Ann Arbor, Mich., 1978.
- 511 Holmes, A. *Principles of Physical Geology*, 2<sup>nd</sup> ed., Thomas Nelson: London, 1965.
- 512 Manga, M.; Castro, J.; Cashman, K.V.; Loevenberg, M. *J. Volcanology Geothermal Res.* **1998**, *87*, 15–28.
- 513 Beckett, R. (Ed.) *Surface and Colloid Chemistry in Natural Waters and Water Treatment*, Plenum Press: New York, 1990.
- 514 Sparks, D.L. (Ed.) *Soil Physical Chemistry*, 2<sup>nd</sup> ed., CRC Press: Boca Raton, 1999.
- 515 Gilluly, J.; Waters, A.C.; Woodford, A.O. *Principles of Geology*, 3<sup>rd</sup> ed., Freeman: San Francisco, 1968.
- 516 Gross, M.G. *Oceanography*, 2<sup>nd</sup> ed., Prentice-Hall: Englewood Cliffs, 1972.
- 517 Tan, K.H. *Principles of Soil Chemistry*, 3<sup>rd</sup> ed., Dekker: New York, 1998.
- 518 Bolt, G.H.; De Boodt, M.F.; Hayes, M.H.B.; McBride, M.B. (Eds.) *Interactions at the Soil Colloid – Soil Solution Interface*, Kluwer Academic: Dordrecht, 1991.
- 519 Senesi, N.; Loffredo, E. The Chemistry of Soil Organic Matter in *Soil Physical Chemistry*, 2<sup>nd</sup> ed., Sparks, D.L. (Ed.) CRC Press: Boca Raton, 1999, pp. 239–370.
- 520 Sparks, D.L. Kinetics and Mechanisms of Chemical Reactions at the Soil Mineral/Water Interface in *Soil Physical Chemistry*, 2<sup>nd</sup> ed., Sparks, D.L. (Ed.) CRC Press: Boca Raton, 1999, pp. 135–191.
- 521 Brown, K.W. Shrinking and Swelling of Clay, Clay Strength, and Other Properties of Clay Soils and Clays in *Minerals in Soil Environments*, Dixon, J.B.; Weed, S.B., Eds., Soil Sci. Soc. Amer.: Madison, 1977, pp. 689–707.
- 522 Buckman, H.O.; Brady, N.C. *The Nature and Properties of Soils*, 7<sup>th</sup> ed., Collier-Macmillan: London, 1969.
- 523 Fountain, J.C., Field Tests of Surfactant Flooding in *Transport and Remediation of Subsurface Contaminants*, American Chemical Society: Washington, 1992, pp. 182–191.
- 524 Pankow, J.F.; Cherry, J.A. *Dense Chlorinated Solvents*, Waterloo Press: Portland, OR, 1996.
- 525 Mackay, D.M.; Cherry, J.A. *Environ. Sci. Technol.*, **1989**, *23*, 630–636.
- 526 Sabatini, D.A.; Knox, R.C.; Harwell, J.H. (Eds.), *Surfactant-Enhanced Subsurface Remediation, Emerging Technologies*, American Chemical Society: Washington, DC, 1995.
- 527 Dwarakanath, V.; Pope, G.A. Surfactant Enhanced Aquifer Remediation in *Surfactants, Fundamentals and Applications in the Petroleum Industry*, Schramm, L.L. (Ed.), Cambridge University Press, Cambridge, UK, 2000, pp. 433–460.
- 528 Vane L.M.; Hitchens, L.; Alvarez, F.R.; Giroux, E.L. *J. Haz. Mat.* **2001**, *B81*, 141–166.
- 529 Fountain, J.C.; Klimek, A.; Beikirch, M.G.; Middleton, T.M. *J. Haz. Mater.*, **1991**, *28*, 295–311.
- 530 Mulligan, C.N.; Yong, R.N.; Gibbs, B.F. *Engineering Geol.*, **2001**, *60*, 371–380.
- 531 Tongcumpou, C.; Acosta, E.J.; Quencer, L.B.; Joseph, A.F.; Scamehorn, J.F.; Sabatini, D.A.; Chavadej, S.; Yanumet, N. *J. Surf. Deterg.* **2003**, *6*, 191–214.
- 532 Hayes, T.D. *U.S. Patent* 6,210,955, Apr. 3, 2001.
- 533 Baran, J.R.; Pope, G.A.; Wade, W.H.; Weerasooriya, V. *Langmuir*, **1994**, *10*, 1146–1150.
- 534 Ooi, K. *Laboratory Evaluation of Surfactant Remediation of Nonaqueous Phase Liquids*. M.S. thesis, University of Texas, Austin, 1998.
- 535 Weerasooriya, V.; Yeh, S.L.; Pope, G.A. Integrated Demonstration of Surfactant-Enhanced Aquifer Remediation (SEAR) with Surfactant Regeneration and Reuse in *Proc. Symp. ACS Surfactant-Based Separations, Recent Advances*, American Chemical Society: Washington, DC, 1998.
- 536 Kimball, S.L., Ph.D. Thesis, Oklahoma State University, Stillwater, OK, 1993.
- 537 West, C.C.; Harwell, J.H. *Environ. Sci. Technol.*, **1992**, *26*, 2324–2329.
- 538 Battelle; Duke Engineering, *Surfactant-Enhanced Aquifer Remediation (SEAR) Design Manual*, Technical Report TR-2206-ENV, Naval Facilities Engineering Command: Washington, April 2002.

- 539 Environmental Security Technology Certification Program, *Surfactant Enhanced DNAPL Removal*, ESTCP Cost and Performance Report CU-9714, U.S. Department of Defense: Washington, August 2001.
- 540 Intera Inc.; Naval Facilities Engineering Service Center, *Surfactant-Enhanced Aquifer Remediation (SEAR) Implementation Manual*, Technical Report TR-2219-ENV, Naval Facilities Engineering Command: Washington, April, 2003.
- 541 Schwuger, M.J.; Subklew, G.; Wöller, N. *Colloids Surfaces A*, **2001**, 186, 229–242.
- 542 Lawler, D.W. *Environ. Sci. Technol.*, **1986**, 20, 856–861.
- 543 Degrémont, *Water Treatment Handbook*, 5<sup>th</sup> ed., Halsted Press: New York, 1979.
- 544 *Zeta-Meter Applications Brochures*, Zeta-Meter Inc., New York, 1982.
- 545 Zeta-Meter applications brochures, Zeta-Meter Inc., NY, 1982.
- 546 Riddick, T.M. *Chem. Eng.* **1961**, 68, 121–126.
- 547 Weber, W.J.; Smith, E.H. *Environ. Sci. Technol.*, **1986**, 20, 970–979.
- 548 Clifford, D.; Subramanian, S.; Sorg, T.J. *Environ. Sci. Technol.*, **1986**, 20, 1072–1080.
- 549 Zabel, T. Flotation in Water Treatment in *The Scientific Basis of Flotation*, Ives, K.J. (Ed.), Martinus Nijhoff: The Hague, 1984, pp. 349–377.
- 550 Hahn, H.H. Wastewater Treatment in *The Scientific Basis of Flotation*, Ives, K.J. (Ed.), Martinus Nijhoff: The Hague, 1984, pp. 379–414.
- 551 Smook, G.A. *Handbook for Pulp & Paper Technologists*, 2<sup>nd</sup> ed., Angus Worldwide: Vancouver, 1992.
- 552 Daling, P.S.; Brandvik, J. *Characterization and Prediction of the Weathering Properties of Oils at Sea, A Manual for the Oils Investigated in the DIWO Project*, IKU SINTEF Group: Trondheim, Norway, 1991.
- 553 *Using Oil Spill Dispersants on the Sea*; National Research Council, National Academy Press: Washington, DC, 1989.
- 554 Fingas, M.F.; Duval, W.S.; Stevenson, G.B. *The Basics of Oil Spill Cleanup*, Environment Canada: Hull, 1979.
- 555 Fay, J.A., *The Spread of Oil Slicks on a Calm Sea in Oil on the Sea*, Hoult, D.P., (Ed.), Plenum Press: New York, 1969, pp. 53–63.
- 556 Lehr, W. J.; Fraga, R.J.; Belen, M.S.; Cekirge, H.M. *Mar. Pollut. Bull.*, **1984**, 15, 326–329.
- 557 Jeffrey, P. G. in *Proc. Oil Spill Conference*, American Petroleum Institute: Washington, 1973, pp. 469–474.
- 558 Cormack, D.; Nichols J.A.; Lynch B. *Investigation of Factors Affecting the Fate of North Sea Oils Discharged at Sea. Part 1: Ekofisk Crude Oil, July 1975–Feb. 1978*, Report LR 273 (OP), Warren Springs Laboratory: Stevenage, England, 1978.
- 559 Mackay, D., Buist, I.; Mascarenhas, R.; Paterson, S. *Oil Spill Process and Models*, Report EE-8, Environment Canada: Ottawa, 1980.
- 560 Reed, M. *Oil Chem. Pollut.*, **1989**, 5, 99–123.
- 561 Spaulding, M.L.; Howlett, E.; Anderson, E.; Jayko, K. *Proc. 15th Annual Arctic and Marine Oil Spill Program, Technical Seminar*, Alberta, Canada, June 9–11, 1992, pp. 15–21.
- 562 Elliot, A.J.; Hurford, N.; Penn, C.J. *Marine Pollution Bulletin* **1986** 17, 308–313.
- 563 Humphrey, B. *Oil Spill Emulsions in Supplementary Notes for Petroleum Emulsions and Applied Emulsion Technology*, Schramm, L.L. (Ed.), Petroleum Recovery Institute: Calgary, AB, 1992, 33 pp.
- 564 Spaulding, M.L. *Oil Chem. Pollut.* **1988**, 4, 39–55.
- 565 Sebastião, P.; Soares, C.G. *Spill Sci. Tech. Bull.*, **1995**, 2, 121–131.
- 566 Mackay, D.; Charles, M.E.; Lee, S.C.; Lun, R.; Ooigen, H.; Romocki, K.; Harner, T.; Ralfs, M., *Studies of the Dissolution and Long Term Weathering of Spilled Crude Oils*, Manuscript Report EE-145, Environment Canada: Ottawa, ON, 1993, 46 pp.
- 567 Chau, A.; Mackay, D., *A Study of Oil Dispersion: The role of Mixing and Weathering*, Manuscript Report EE-104, Environment Canada: Ottawa, ON, 1988, 46 pp.
- 568 Canevari, G.P. *Marine Pollution Bulletin*, **1982**, 13, 49–54.
- 569 Mackay, D.; Nowak, M. Water-in-Oil Emulsions: Some Recent Advances in *Proc. 7th Annual Arctic Marine Oilspill Program, Technical Seminar*, Environment Canada: Ottawa, 1984, pp. 37–46.
- 570 Stiver, W.; Nowak, M.; Shiu, W.Y.; Mackay, D. Recent University of Toronto Studies on the Fate and Effects of Oil in the Marine Environment in *Proc. 6th Ann. Arctic Marine Oilspill Program, Technical Seminar*, Environment Canada, Ottawa, 1983, pp. 24–29.

- 571 Sjöblom, J.; Urdahl, O.; Borve, K.G.N.; Mingyuan, L.; Saeten, J.O.; Christy, A.A.; Gu, T. *Adv. Coll. Interface Sci.*, **1992**, *41*, 241–271.
- 572 Urdahl, O.; Sjöblom, J. J. *Dispersion Sci. Technol.*, **1995**, *16*, 557–574.
- 573 Bobra, M.A. Water-in-Oil Emulsification: A Physicochemical Study in *Proceedings of the International Oil Spill Conference*; American Petroleum Institute: Washington, DC, 1991, paper 177, pp. 483–488.
- 574 Bobra, M.A. *A Study of Water-in-Oil Emulsification*; Manuscript Report EE-132, Environment Canada: Ottawa, ON, 1992, 74 pp.
- 575 Canevari, G.P. Basic Study Reveals How Different Crude Oils Influence Dispersant Performance in *Proceedings of the Oil Spill Conference*; API Publication 4452, American Petroleum Institute: Washington, DC, 1987, pp. 293–296.
- 576 Mackay, D. *Formation and Stability of Water-in-Oil Emulsions*; Manuscript Report EE-93, Environment Canada: Ottawa, ON, 1987, 44 pp.
- 577 Urdahl, O.; Sjöblom, J. J. *Dispersion Sci. Technol.* **1995**, *16*, 557–574.
- 578 Clayton, J.R.; Payne, J.R.; Farlow, J.S. *Oil Spill Dispersants*, CRC Press: Boca Raton, FL, 1993.
- 579 Fingas, M. Use of Surfactants for Environmental Applications in *Surfactants, Fundamentals and Applications in the Petroleum Industry*, Schramm, L.L. (Ed.), Cambridge University Press: Cambridge, 2000, pp. 461–540.
- 580 Cormack, D.; Lynch, W.J.; Dowsett, B.D. *Oil Chem. Pollut.*, **1986/87**, *3*, 87–103.
- 581 Fingas, M.F.; Sergy, G.; Wang, Z.; Brown, C.; Jokuty, P.; Lambert, P.; Fieldhouse, B.; Blenkinsopp, S. *Spill Technology Newsletter*, **1994**, *19(3)*, 1–10.
- 582 Bocard, C.; Gatellier, C. Breaking of Fresh and Weathered Emulsions by Chemicals in *Proceedings of the Oil Spill Conference*, API Publication 4452, American Petroleum Institute: Washington, DC, 1981, pp. 601–607.
- 583 Fingas, M.; Bier, I.; Bobra, M.; Callaghan, S. Studies on the Physical and Chemical Behaviour of Oil and Dispersant Mixtures in *Proc. Int. Oil Spill Conference*, 1991, paper 137.
- 584 Fingas, M.F.; Duval, W.; Stevenson, G.; *The Basics of Oil Spill Cleanup*; Government Publishing Centre, Ottawa, Ontario, 1979.
- 585 Fingas, M.F.; Kyle, D.A.; Tennyson, E.J. Dispersant Effectiveness: Studies into the Causes of Effectiveness Variations in *The Use of Chemicals in Oil Spill Response*, Lane, P., Ed., ASTM STP 1252, American Society for Testing and Materials: Philadelphia, 1995, pp. 92–132.
- 586 Fingas, M.F.; Kyle, D.A.; Wang, Z.; Handfield, D.; Lanuzzi, D.; Ackerman, F. Laboratory Testing of Oil Spill Dispersants in *The Use of Chemicals in Oil Spill Response*, Lane, P., Ed., ASTM STP 1252, American Society for Testing and Materials: Philadelphia, 1995, pp. 3–40.
- 587 Fiocco, R.J.; Lessard, R.R.; Canevari, G.P.; Becker, K.W.; Daling, P.S. in *The Use of Chemicals in Oil Spill Response*; Lane, P., Ed.; American Society for Testing and Materials: Philadelphia, PA, 1995, pp. 299–309.
- 588 Wang, Z.; Fingas, M. *Environ. Sci. Technol.* **1996**, *30*, 3351–3361.
- 589 Nachtman, T.J.; Hull, J.H.; O'Shea, P. U.S. Patent 6,096,373, Aug. 1, 2000.
- 590 Kittle, P.A. U.S. Patent 4,990,373, Feb. 5, 1991.
- 591 Kittle, P.A.; Schmidt, C.E. *Comparison of Long Duration Foam, Synthetic Tarpaulins, Geotextiles, and Soil as Subtitle D Compliant Daily Cover Materials for Sanitary Landfills*, Technical Report, Aquafoam Inc.: West Chester, PA February, 1992.
- 592 Nachtman, T.J.; Hull, J.H. U.S. Patent 5,849,364, Dec. 15, 1998.
- 593 Aubert, W.G.; Knowles, C.R. U.S. Patent 5,782,580, Jul. 21, 1998.
- 594 Kent, D.W.; Berger, T.W. U.S. Patent 4,795,590, Jan. 3, 1989.
- 595 Raspet, R.; Griffiths, S.K. *J. Acoust. Soc. Am.* **1983**, *74*, 1757–1763.
- 596 Raspet, R.; Butler, P.B.; Jahani, F. *Appl. Acoust.* **1987**, *22*, 35–45.
- 597 Clark, C.J.; Bennett, E.M. U.S. Patent 4,589,341, May 20, 1986.
- 598 Thach, S.; Miller, K.C.; Schultz, K.S. U.S. Patent 5,434,192, Jul. 18, 1995.
- 599 Horne, F.F. U.S. Patent 3,880,176, Apr. 29, 1975.
- 600 Horne, F.F. U.S. Patent 3,892,588, Jul. 1, 1975.
- 601 Tiernan, B.H.; Woogerd, S.M. U.S. Patent 5,346,699, Sept. 13, 1994.
- 602 Magnuson-Hawkins, S.J. U.S. Patent 6,290,992, Sept. 18, 2001.
- 603 Ouellette, J. *Discover*, **2002**, *June*, 25–27.

- 604 Ember, L. *Chem. Eng. News*, 1999, March 8, p. 10.
- 605 Browne, M.W. "Chemists Create Foam To Fight Nerve Gases" *New York Times*, 1999, March 16, p. F2.
- 606 Aplin, C.L.; Argall, G.O. (Eds.), *Tailing Disposal Today*, Miller Freeman: San Francisco, 1973.
- 607 Cowper, N.T. Case Studies of Some Major Projects in *Slurry Handling Design of Solid-Liquid Systems*, Brown, N.P.; Heywood, N.I. (Eds.), Elsevier: London, 1991, pp. 625–652.
- 608 Stephens, H.S.; Gittins, L. (Eds.) *Proc. 7<sup>th</sup> Int. Conf. Hydraulic Transport of Solids in Pipes*, BHRA Fluid Engineering: Cranford, U.K., 1980.
- 609 Shelley, J.A. Black Mesa Pipeline's Operational and Equipment Experience in *Proc. 16<sup>th</sup> Int. Conf. Coal & Slurry Technologies*, Coal & Slurry Technol. Assoc.: Washington, 1991, pp. 19–30.
- 610 Greenland, P. *Hydraulic Mining in California*, Arthur H Clark: Spokane, WA, 2000.
- 611 WaterJet Technol. Assoc., *Proc. U.S. Water Jet Conference*, 1<sup>st</sup> conf., 1981; 2<sup>nd</sup>, 1983; 3<sup>rd</sup>, 1985; 4<sup>th</sup>, 1987, WaterJet Technology Assoc.: St. Louis, MO.
- 612 Marsden, S.S.; Walter, J. A Laboratory Study of the Use of Subsurface Hydraulic Mining of Tar Sands in *Proc. Ann. Tech. Conf. SPE*, Society of Petroleum Engineers: Richardson, TX, 1986, SPE paper 861080.
- 613 Palmer, R.N.; James, I.C.; Hirsch, R.M. *Comparative Assessment of Water Use and Environmental Implications of Coal Slurry Pipelines*, Report 77-698, U.S. Geological Survey: Reston, VA, August, 1977.
- 614 Horsley, R.R.; Reizes, J.A. The Effect of Zeta Potential on the Head Loss Gradient for Slurry Pipelines with Varying Slurry Concentrations, in *Proc. 7<sup>th</sup> Int. Conf. Hydraulic Transport of Solids in Pipes*, Stephens, H.S.; Gittins, L. (Eds.), BHRA Fluid Engineering: Cranford, U.K., 1980, pp. 163–172.
- 615 Brown, N.P.; Heywood, N.I. (Eds.), *Slurry Handling Design of Solid-Liquid Systems*, Elsevier: London, 1991.
- 616 Shook, C.A.; Roco, M.C. *Slurry Flow, Principles and Practice*, Butterworth-Heinemann: Boston, 1991.
- 617 Govier, G.W.; Aziz, K. *The Flow of Complex Mixtures in Pipes*, Van Nostrand Reinhold: New York, 1972.
- 618 Shamlou, P.A. (Ed.) *Processing of Solid-Liquid Suspensions*, Butterworth-Heinemann: Boston, 1993.
- 619 Richardson, P.E. Surface Chemistry of Sulfide Flotation in *Mineral Surfaces*, Vaughan, D.J.; Patrick, R.A.D. (Eds.), Chapman and Hall: London, 1995, pp. 261–302.
- 620 Kitchener, J.A. The Froth Flotation Process in *The Scientific Basis of Flotation*, Ives, K.J. (Ed.), Martinus Nijhoff: The Hague, 1984, pp. 3–51.
- 621 Shergold, H.L. Flotation in Mineral Processing in *The Scientific Basis of Flotation*, Ives, K.J. (Ed.), Martinus Nijhoff: The Hague, 1984, pp. 229–287.
- 622 Gaudin, A.M. *Flotation*, 2<sup>nd</sup> ed., McGraw-Hill: New York, 1957.
- 623 Fuerstenau, D.W. (Ed.) *Froth Flotation*, American Institute of Mining, Metallurgical, and Petroleum Engineers: New York, 1962.
- 624 Finch, J.A.; Dobby, G.S. *Column Flotation*, Pergamon Press: Oxford, 1990.
- 625 Barbery, G. Engineering Aspects of Flotation in the Minerals Industry in *The Scientific Basis of Flotation*, Ives, K.J. (Ed.), Martinus Nijhoff: The Hague, 1984, pp. 289–348.
- 626 Berkowitz, N. *An Introduction to Coal Technology*, Academic Press: New York, 1979.
- 627 Arbiter, N.; Fujii, Y.; Raja, A. Surface Properties of Hydrophobic Solids in *Advances in Interfacial Phenomena of Particulate/Solution/Gas Systems; Applications to Flotation Research*, Somasundaran, P.; Grieves, R.B. (Eds.), American Institute of Chemical Engineers: New York, 1975, pp. 176–182.
- 628 Chander, S.; Wie, J.M.; Fuerstenau, D.W. On the Native Floatability and Surface Properties of Naturally Hydrophobic Solids in *Advances in Interfacial Phenomena of Particulate/Solution/Gas Systems; Applications to Flotation Research*, Somasundaran, P.; Grieves, R.B. (Eds.), American Institute of Chemical Engineers: New York, 1975, pp. 183–191.
- 629 J. Prost, F. Rondelez, *Nature*, 1991, 350 (April Supplement), 11–23.
- 630 Laskowski, J.S.; Ralston, J. *Colloid Chemistry in Mineral Processing*, Elsevier: Amsterdam, 1992.
- 631 Song, S.; Zhang, Y.; Wu, K.; Lopez-Valdivieso, A.; Lu, S. J. *Dispersion Sci. Technol.*, 2004, 25, 75–81.
- 632 Song, S.; Lopez-Valdivieso, A.; Reyes-Bahena, J.L.; Bermejo-Perez, H.I.; Trass, O. J. *Colloid Interface Sci.* 2000, 227, 272–281.

- 633 Hall, C.W.; Farrall, A.W.; Rippen, A.L. *Encyclopedia of Food Engineering*, Avi Publishing Co.: Westport, 1971.
- 634 Fine Tailings Fundamentals Consortium, *Advances in Oil Sands Tailings Research*, Alberta Department of Energy, Edmonton, AB, Canada, 1995.
- 635 Rogers, M.E.; Ferguson, D.; MacKinnon, M. Water Management Challenges at the World's Largest Integrated Oil Sands Mining and Refining Complex in *Proceedings of NACE International Conference and Exposition: Corrosion 96*, North American Corrosion Engineers: Houston, TX, 1996, paper 568, 26 pp.
- 636 Erskine, H.L. Suncor Hot Water Process in *Handbook of Synfuels Technology*, Meyers, R.A., (Ed.), McGraw-Hill: New York, 1984; pp 5–1 to 5–79.
- 637 Morgenstern, N.R.; Scott, J.D. Geotechnics of Fine Tailings Management in *Proceedings of Geoenvironment 2000 Conference*, Geotechnical Special Publication 46, ASCE: New Orleans, 1995, pp. 1663–1683.
- 638 Fine Tails Fundamentals Consortium, *Advances in Oil Sands Tailings Research*, Vol 1, Alberta Dept. of Energy: Edmonton, AB, 1995.
- 639 Boerger, H.; MacKinnon, M.; Van Meer, T.; Verbeek, A. Wet Landscape Option for Reclamation of Oil Sands Fine Tails in *Proc. of the 2<sup>nd</sup> International Conference on Environmental Issues and Management of Waste in Energy and Mineral Production*; Singhal, R.K.; Mehrotra, A.K.; Fytas, K.; Collins, J. (Eds.), Balkema: Rotterdam, 1992, pp. 1248–1261.
- 640 Gulley, J.; MacKinnon, M. Fine Tails Reclamation Utilizing a Wet Landscape Approach in *Proc. Fine Tailings Symposium in Oil Sands: Our Petroleum Future Conference*; Liu, J.K. (Ed.), Alberta Oil Sands Technology and Research Authority: Edmonton, AB, 1993, Paper F23, 24 pp.
- 641 Nelson, L.R.; Gulley, J.R.; MacKinnon, M. Oil Sands Fine Tails in *Proc. 6<sup>th</sup> UNITAR Conference on Heavy Crude and Tar Sands*; UNITAR, 1995, pp. 705–718.
- 642 Schramm, L.L.; Stasiuk, E.N.; MacKinnon, M. Surfactants in Athabasca Oil Sands Slurry Conditioning, Flotation Recovery, and Tailings Processes in *Surfactants, Fundamentals and Applications in the Petroleum Industry*, Schramm, L.L. (Ed.), Cambridge University Press, Cambridge, UK, 2000, pp. 365–430.
- 643 Mikula, R.J.; Kasperski, K.L.; Burns, R.D.; MacKinnon, M.D. Nature and Fate of Oil Sands Fine Tailings in *Suspensions, Fundamentals and Applications in the Petroleum Industry*; Schramm, L.L. (Ed.), American Chemical Society: Washington, DC, 1996; pp. 677–723.
- 644 Canadian Oil Sands Network for Research and Development *Naphthenic Acids, Background Information Discussion Report*; Alberta Department of Energy: Edmonton, AB, 65pp.
- 645 Kittle, P.A. *U.S. Patent* 4,561,905, Dec. 31, 1985.
- 646 Cole, H.W. *U.S. Patent* 4,400,220, Aug. 23, 1983.
- 647 Salyer, I.O.; Schwendeman, J.L.; Sun, S. *U.S. Patent* 3,954,662, May 4, 1976.
- 648 Netting, D.I. *U.S. Patent* 4,380,459, Apr. 19, 1983.
- 649 Cole, H.W.; Taylor, S.E. *U.S. Patent* 5,069,723, Dec. 3, 1991.
- 650 Cole, H.W.; Taylor, S.E. *U.S. Patent* 5,039,348, Aug. 13, 1991.
- 651 Speight, J.G., *The Chemistry and Technology of Petroleum*, 3<sup>rd</sup> ed., Marcel Dekker, New York, 1999.
- 652 Martinez, A.R. Report of Working Group on Definitions in *The Future of Heavy Crude and Tar Sands*; Meyer, R.F.; Wynn, J.C.; Olson, J.C., Eds.; UNITAR: New York, NY, 1982, pp. ixvii–ixviii.
- 653 Danyluk, M.; Galbraith, B.; Omana, R. Toward Definitions for Heavy Crude Oil and Tar Sands in *The Future of Heavy Crude and Tar Sands*; Meyer, R.F.; Wynn, J.C.; Olson, J.C., Eds.; UNITAR: New York, NY, 1982, pp. 3–6.
- 654 Khayan, M. Proposed Classification and Definitions for Heavy Crude Oils and Tar Sands in *The Future of Heavy Crude and Tar Sands*; Meyer, R.F.; Wynn, J.C.; Olson, J.C., Eds.; UNITAR: New York, NY, 1982, pp. 7–11.
- 655 Gray, G.R.; Darley, H.C.H., *Composition and Properties of Drilling Fluids*, 4<sup>th</sup> ed., Gulf Publishing Co.: Houston, 1980.
- 656 Chiligarian, G.V.; Vorabtr, P., (Eds.), *Drilling and Drilling Fluids*, Elsevier: Amstredam, 1981.
- 657 Ayeni, K.; Osisanya, S.O. Evaluation of Commonly Used Fluid Rheological Models Using Developed Drilling Hydraulic Simulator in *Proc. 5th Canadian International Petroleum Conference*, The Petroleum Society: Calgary,

- AB, Canada, June 8–10, 2004, paper 2004-039.
- 658 Maitland, G.C. *Curr. Opin. Coll. Int. Sci.* **2000**, *5*, 301–311.
- 659 Borchardt, J.K. Chemicals Used in Oil-Field Applications in *Oil-Field Chemistry*, Borchardt, J.K.; Yen, T.F., Eds., American Chemical Society: Washington, DC, 1989, pp. 3–54.
- 660 Anderson, G.W. in *Proceedings, Rotary Drilling Conference of IADC*, Int. Assoc. Drilling Contractors: Houston, TX, March 9–12, 1976.
- 661 Bentsen, N.W.; Veny, J.N. *J. Petrol. Technol.*, **1976**, *October*, 1237–1240.
- 662 Hutchinson, S.O.; Anderson, G.W. *Oil and Gas J.*, **1972** *May*, 74–79.
- 663 Beyer, A.H.; Milhone, R.S.; Foote, R.W. Flow Behavior of Foam as a Well Circulating Fluid in *Proceedings, 47<sup>th</sup> Annual Fall Meeting*, Society of Petroleum Engineers: Richardson, TX, 1972, paper SPE 3986.
- 664 Anderson, G.W. *World Oil*, **1971**, *Sept.*, 39–42.
- 665 Anderson, G.W.; Harrison, T.F.; Hutchinson, S.O. *The Drilling Contractor*, **1966**, *May–June*, 44–47.
- 666 Lorenz, H. *World Oil*, **1980**, *June*, 187–193.
- 667 Rovig, J. *APPEA J.* **1996**, 557–561.
- 668 Biesman, T.; Emeh, V. An Introduction to Underbalanced Drilling in *Proc., 1<sup>st</sup> Underbalanced Drilling International Conference*, The Hague, Netherlands, 1995.
- 669 Li, Y.; Kuru, E. *J. Can. Petrol. Technol.* **2003**, *42*, 54–61.
- 670 Russell, B.A. How Surface Hole Drilling was Improved 65% in *Proc., SPE/IADC Drilling Conference*, Society of Petroleum Engineers: Richardson, TX, 1993, SPE/DOE paper 25766.
- 671 Southwell, G.P. *U.S. Patent* 5 356 565, Oct. 18, 1994.
- 672 Guillot, D.; Baret, J.F. Principles and Applications of Cement Slurries Principles and Applications of Cement Slurries in *Suspensions, Fundamentals and Applications in the Petroleum Industry*, Schramm, L.L. (Ed.), American Chemical Society: Washington, 1996, pp. 601–635.
- 673 Dowell Schlumberger, *Cementing Technology*, Nova Communication Ltd.: London, 1984.
- 674 Economides, M.J.; Nolte, K.G. (Eds.), *Reservoir Stimulation*, 3<sup>rd</sup> ed., Wiley: New York, 2000.
- 675 Bradley, H.B. (Ed.) *Petroleum Engineering Handbook*, Society of Petroleum Engineers: Richardson, TX, 1992.
- 676 Shah, S.N. Suspensions in Hydraulic Fracturing Suspensions in Hydraulic Fracturing in *Suspensions, Fundamentals and Applications in the Petroleum Industry*, Schramm, L.L. (Ed.), American Chemical Society: Washington, 1996, pp. 565–599.
- 677 Bani, E.S.; Tremblay, B.; Polikar, M.; Wiwchar, B.; Huang, H. *J. Can. Petrol. Technol.* **2004**, *43*, 49–55.
- 678 Nasr-el-din, H.A., Surfactant Use in Acid Stimulation in *Surfactants, Fundamentals and Applications in the Petroleum Industry*, Schramm, L.L. (Ed.), Cambridge University Press, Cambridge, UK, 2000, pp. 329–364.
- 679 Sinclair, A.R.; Terry, W.M.; Kiel, O.M. Polymer Emulsion Fracturing in *Proc., Annual Technical Conference of SPE*; Society of Petroleum Engineers: Richardson, TX, 1973, paper SPE 4675.
- 680 Bentsen, N.W.; Veny, J.N. *J. Petrol. Technol.* **1976**, *October*, 1237–1240.
- 681 Hutchinson, S.O.; Anderson, G.W., *Oil and Gas J.*, **1972**, *May*, 74–79.
- 682 Harms, W.M. in *Oil-Field Chemistry*, Borchardt, J.K.; Yen, T.F. (Eds.), American Chemical Society: Washington, DC, 1989, pp. 55–100.
- 683 Valko, P.; Economides, M.J.; Baumgartner, S.A.; McElfresh, P.M. The Rheological Properties of Carbon Dioxide and Nitrogen Foams in *Proc., Symposium on Formation Damage Control*, Society of Petroleum Engineers: Richardson, TX, 1992, paper SPE 23778.
- 684 Harris, P.C., Application of Foam Fluids To Minimize Damage During Fracturing in *Proceedings, International Meeting on Petroleum Engineering*, Society of Petroleum Engineers: Richardson, TX, 1992, paper SPE 22394.
- 685 Chambers, D.J. Foams for Well Stimulation in *Foams, Fundamentals and Applications in the Petroleum Industry*, Schramm, L.L. (Ed.), American Chemical Society: Washington, DC, 1994, pp. 355–404.
- 686 Harris, P.C. A Comparison of Mixed Gas Foams With N<sub>2</sub> and CO<sub>2</sub> Foam Fracturing Fluids on a Flow Loop Viscometer in *Proc., Annual Technical Conference of SPE*; Society of Petroleum Engineers: New Orleans, LA, 1990, paper SPE 20642.

- 687 Watkins, E.K.; Wendorff, C.L.; Ainley, B.R. A New Crosslinked Foamed Fracturing Fluid in *Proc., Annual Technical Conference of SPE*, Society of Petroleum Engineers: Richardson, TX, 1983, paper SPE 12027.
- 688 Nasr-El-Din, H.A.; Al-Othman, A.M.; Taylor, K.C.; Al-Ghamdi, A.H. *J. Petrol. Sci. Eng.*, **2004**, *43*, 57–73.
- 689 Economides, M.J.; Nolte, K.G. (Eds.), *Reservoir Stimulation*, 3<sup>rd</sup> ed., Wiley, New York, 2000.
- 690 Morrow, N.R. (Ed.) *Interfacial Phenomena in Petroleum Recovery*, Dekker: New York, 1991.
- 691 Shah, D.O.; Schechter, R.S. (Eds.) *Improved Oil Recovery by Surfactant and Polymer Flooding*, Academic Press: New York, 1977.
- 692 Clark, N.J. *Elements of Petroleum Reservoirs*, Society of Petroleum Engineers: Richardson, TX, 1969.
- 693 Dow, D.B. *Oil-Field Emulsions*; Bulletin 250, US Bureau of Mines: Washington, DC, 1926.
- 694 Chung, K.H.; Butler, R.M. *J. Can. Petrol. Technol.* **1989**, *28*, 48–55.
- 695 Vittoratos, E. *J. Can. Petrol. Technol.* **1991**, *30*, 82–86.
- 696 Vittoratos, E. In-Situ Emulsification: Interpreting Production Data in *Supplementary Notes for Petroleum Emulsions and Applied Emulsion Technology*, Schramm, L.L. (Ed.), Petroleum Recovery Institute: Calgary, AB, 1992, 20 pp.
- 697 Hawkins, B.F.; Adamache, I.; Leopold, G. Solids Production and Control in Petroleum Recovery in *Suspensions, Fundamentals and Applications in the Petroleum Industry*, Schramm, L.L., Ed., American Chemical Society: Washington, 1996, pp. 403–459.
- 698 Maini, B.; Sarma, H. Role of Nonpolar Foams in Production of Heavy Oils in *Foams, Fundamentals and Applications in the Petroleum Industry*, Schramm, L.L. (Ed.), American Chemical Society: Washington, DC, 1994, pp. 405–420.
- 699 Poettmann, F.H. *Microemulsion Flooding in Improved Oil Recovery*, Interstate Compact Commission: Oklahoma City, OK, 1983; pp. 173–250.
- 700 Neogi, P. Oil Recovery and Microemulsions in *Microemulsions: Structure and Dynamics*, Friberg, S.E.; Bothorel, P. (Eds.), CRC Press: Boca Raton, FL, 1987, pp. 197–212.
- 701 Bansal, V.K.; Shah, D.O. Microemulsions and Tertiary Oil Recovery in *Microemulsions Theory and Practice*, Prince, L.M. (Ed.), Academic Press: New York, NY, 1977, pp. 149–173.
- 702 Robb, I.D. (Ed.), *Microemulsions*, Plenum: New York, 1977.
- 703 Shah, D.O. (Ed.) *Macro- and Microemulsions: Theory and Applications*; American Chemical Society: Washington, DC, 1985.
- 704 Donaldson, E.C.; Chilingarian, G.V.; Yen, T.F. (Eds.) *Enhanced Oil Recovery, II*, Elsevier: Amsterdam, 1989.
- 705 Stegemeier, G.L. Mechanisms of Entrapment and Mobilization of Oil in Porous Media in *Improved Oil Recovery by Surfactant and Polymer Flooding*, Shah, D.O.; Schechter, R.S. (Eds.), Academic Press: New York, 1977, pp. 55–92.
- 706 Friberg, S.E.; Bothorel, P. (Eds.), *Microemulsions: Structure and Dynamics*, CRC Press: Boca Raton, FL, 1987.
- 707 Sharma, M.K. Surfactants in Enhanced Petroleum Recovery Processes: A Review in *Particle Technology and Surface Phenomena in Minerals and Petroleum*, Sharma, M.K.; Sharma, G.D. (Eds.), Plenum: New York, 1991, pp. 199–222.
- 708 Smith, D.H. (Ed.) *Surfactant-Based Mobility Control*, American Chemical Society: Washington, 1988.
- 709 Acevedo, S.; Gutierrez, X.; Rivas, H. *J. Colloid Interface Sci.*, **2001**, *242*, 230–238.
- 710 Nasr-El-Din, H.A.; Green, K.A.; Schramm, L.L. *Rev. Inst. Franç. du Pétrole*, **1994**, *49*, 359–377.
- 711 Prince, L.M. (Ed.), *Microemulsions Theory and Practice*, Academic Press: New York, 1977.
- 712 Neogi, P. Oil Recovery and Microemulsions in *Microemulsions: Structure and Dynamics*, Friberg, S.E.; Bothorel, P. (Eds.), CRC Press: Boca Raton, FL, 1987, pp. 197–212.
- 713 Reed, R.L.; Healy, R.N. Some Physico-Chemical Aspects of Microemulsion Flooding: A Review in *Improved Oil Recovery by Surfactant and Polymer Flooding*, Shah, D.O.; Schechter, R.S. (Eds.), Academic Press: New York, 1977, pp. 383–438.
- 714 Thomas, S.; Farouq Ali, S. M.; *J. Can. Pet. Technol.* **1992**, *31*, 53–60.
- 715 Moritis, G. *Oil Gas J.*, **1992**, *4*, 51–71.
- 716 Chapotin, D.; Lomer, J.F.; Putz, A. The Chateaufort (France) Industrial Microemulsion Pilot Design and Performance in *Proc., SPE/DOE 5<sup>th</sup> Symposium on EOR*, Society of Petroleum Engineers: Richardson, Texas, 1986, paper SPE/DOE 14955.

- 717 Reppert, T.R.; Bragg, J.R.; Wilkinson, J.R.; Snow, T.M.; Maer Jr., N.K.; Gale, W.W. Second Ripley Surfactant Flood Pilot Test in *Proc., 7<sup>th</sup> Symposium on Enhanced Oil Recovery*, Society of Petroleum Engineers: Richardson, Texas, 1990, paper SPE/DOE 20219.
- 718 Broz, J.S.; French, T.R.; Corroll, H.B. Blocking of High Permeability Zones in Steamflooding by Emulsions in *Proc., 3<sup>rd</sup> UNITAR/UNDP Internat. Conf. Heavy Crude and Tar Sands*, United Nations Institute for Training and Research: New York, 1985, pp. 444–451.
- 719 French, T.R.; Broz, J.S.; Lorenz, P.B.; Bertus, K.M. Use of Emulsions for Mobility Control During Steamflooding in *Proceedings, 56<sup>th</sup> Calif. Regional Meeting*: Society of Petroleum Engineers: Richardson, Texas, 1986, paper SPE 15052.
- 720 Woo, R.; Jackson, C.; Maini, B.B., unpublished results, Petroleum Recovery Institute: Calgary, AB, Canada, 1992.
- 721 Sarma, H.K.; Maini, B.B., unpublished results, Petroleum Recovery Institute: Calgary, AB, Canada, 1992.
- 722 Holm, L.W., *J. Petrol. Technol.*, **1970**, *22*, 1499–1506.
- 723 Kuehne, D.L.; Ehman, D.I.; Emanuel, A.S., Design and Engineering of a Nitrogen-Foam Field Trial in *Proc., SPE/DOE Symposium on EOR*, Society of Petroleum Engineers: Richardson, TX, 1988, SPE/DOE paper 17381.
- 724 Thach, S.; Miller, K.C.; Lai, Q.J.; Sanders, G.S.; Styler, J.W.; Lane, R.H., High-Stability Foams for Long-Term Suppression of Hydrocarbon Vapors in *Proc., SPE Annual Technical Conference*, Society of Petroleum Engineers: Richardson, TX, 1996, SPE paper 36616.
- 725 Liu, P.C.; Besserer, G.J., Application of Foam Injection in Triassic Pool, Canada: Laboratory and Field Test Results in *Proc., SPE 63<sup>rd</sup> Annual Technical Conf.*, Society of Petroleum Engineers: Richardson, TX, 1988, SPE paper 18080.
- 726 Arra, M.G.; Skauge, A., A Foam Pilot in a North Sea Oil Reservoir: Preparation for a Production Well Treatment *Proc., SPE 69<sup>th</sup> Annual Technical Conf.*, Society of Petroleum Engineers: Richardson, TX, 1994, SPE paper 28599.
- 727 Arra, M.G.; Skauge, A.; Sognesand, S.; Stenhaug, M., *Petrol. Geoscience*, **1994**, *2*, 125–132.
- 728 Svorstøl, I.; Blaker, T.; Tham, M.J.; Hjellen, A., A Production Well Foam Pilot in the North Sea Snorre Field – Application of Foam to Control Premature Gas Breakthrough in *Proc., 9<sup>th</sup> European Symposium on Improved Oil Recovery*, The Hague, The Netherlands, 1997 paper 001.
- 729 Holm, L.W.; Garrison, W.H., *SPE Res. Eng.*, **1988**, *3*, 112–118.
- 730 Heller, J.P. CO<sub>2</sub> Foams in Enhanced Oil Recovery in *Foams, Fundamentals and Applications in the Petroleum Industry*, Schramm, L.L. (Ed.), American Chemical Society: Washington, DC, 1994, pp. 201–234.
- 731 Cooke, R.W.; Eson, R.L. Field Results of Optimizing the Steam Foam Diversion Process in Cyclic Steam Applications in *Proc., SPE International Thermal Operations Symposium*, Society of Petroleum Engineers: Richardson, TX, 1991, SPE paper 21531.
- 732 Patzek, T.W.; Koinis, M.T., Kern River Steam Foam Pilots in *Proc., SPE/DOE Symposium on EOR*, Society of Petroleum Engineers: Richardson, TX, 1988, SPE/DOE paper 17380.
- 733 Isaacs, E.E.; Ivory, J.; Green, M.K. Steam-Foams for Heavy Oil and Bitumen Recovery in *Foams, Fundamentals and Applications in the Petroleum Industry*, Schramm, L.L. (Ed.), American Chemical Society: Washington, DC, 1994, pp. 235–258.
- 734 Mannhardt, K.; Schramm, L.L.; Novosad, J.J. *Colloids and Surfaces*, **1992**, *68*, 37–53.
- 735 Mannhardt, K.; Novosad, J.J. Adsorption of Foam-Forming Surfactants for Hydrocarbon-Miscible Flooding at High Salinities in *Foams, Fundamentals and Applications in the Petroleum Industry*, Schramm, L.L. (Ed.), American Chemical Society: Washington, 1994, pp. 259–316.
- 736 Novosad, J.J. On Minimizing Adsorption of Foam-Forming Surfactants in Porous Media in *Chemicals in the Oil Industry: Developments and Applications*, Ogden, P.H. (Ed.), Royal Society of Chemistry: Cambridge, 1991, pp. 159–173.
- 737 Wesson, L.L. and Harwell, G.H., Surfactant Adsorption in Porous Media in *Surfactants, Fundamentals and Applications in the Petroleum Industry*, Schramm, L.L. (Ed.), Cambridge University Press, Cambridge, UK, 2000, pp. 121–158.



- 738 Malmberg, E.W.; Smith, L. The Adsorption Losses of Surfactants in Tertiary Recovery Systems in Porous Media in *Improved Oil Recovery by Surfactant and Polymer Flooding*, Shah, D.O.; Schechter, R.S. (Eds.), Academic Press: New York, 1977, pp. 275–292.
- 739 Chad, J.; Matsalla, P.; Novosad, J.J. Foam Forming Surfactants in Pembina/Ostracod 'G' Pool in *Proc., CIM Annual Technical Meeting*, Canadian Inst. Mining, Metallurgical and Petroleum Engineers: Calgary, AB, 1988, paper CIM 88-39-40.
- 740 Rendall, W.A.; Ayasse, C.; Novosad, J.J. *U.S. Patent* 5,074,358, Dec. 24, 1991.
- 741 Schramm, L.L.; Ayasse, C.; Mannhardt, K.; Novosad, J.J. *U.S. Patent* 5,060,727, Oct. 29, 1991.
- 742 Rand, P.B. *U.S. Patent* 4,442,018, 1984.
- 743 Patton, J.T.; Patton, J.T.; Kuntamukkula, M.S.; Holbrook, S.T. *Polymer Preprints*, 1981, 22, 46–48.
- 744 Dauben, D.L. *U.S. Patent* 3,530,940, 1970.
- 745 Ram Sarma, D.S.H.S.; Pandit, J.; Khilar, K.C., *J. Colloid Interface Sci.* 1988, 124, 339–348.
- 746 Sydansk, R.D., Polymer-Enhanced Foam: Laboratory Development and Evaluation in *Proc., International Symposium on Oilfield Chemistry*, Society of Petroleum Engineers: Richardson, TX, 1993, SPE paper 25168.
- 747 Lioni-Addad, S.; di Meglio, J.-M., *Langmuir*, 1992, 8, 324–327.
- 748 Pradhan, M.S.; Sarma, D.S.H.R.; Khilar, K.C. *J. Colloid Interface Sci.*, 1990, 139, 519–526.
- 749 Pradhan, M.S.; Khilar, K.C. *J. Colloid Interface Sci.*, 1994, 168, 333–338.
- 750 Friberg, S.E.; Fang, J.-H. *J. Colloid Interface Sci.* 1987, 118, 543–552.
- 751 Sydansk, R.D., Polymer-Enhanced Foam Propagation Through High-Permeability Sandpacks *Proceedings, Internat. Symp. Oilfield Chem.*, Society of Petroleum Engineers: Richardson, TX, 1993, SPE paper 25175.
- 752 Bernard, G.G.; Holm, L.W., *U.S. Patent* 3,393,738, 1968.
- 753 Zhukov, I.N.; Polozova, T.I.; Shatava, O.S. *Kolloidn. Zh.* 1987, 49, 758–762.
- 754 Hazlett, R.D.; Strom, E.T., *U.S. Patent* 4,844,163, July 4, 1989.
- 755 Miller, M.J.; Fogler, H.S., A Mechanistic Investigation of Waterflood Diversion Using Foamed Gels *Proc., Annual Technical Conf.*, Society of Petroleum Engineers: Richardson, TX, 1992, SPE paper 24662.
- 756 Sydansk, R.D., *U.S. Patent* 5,105,884, April 21, 1992.
- 757 Willhite, G.P.; Dominguez, J.G. Mechanisms of Polymer Retention in Porous Media in *Improved Oil Recovery by Surfactant and Polymer Flooding*, Shah, D.O.; Schechter, R.S. (Eds.), Academic Press: New York, 1977, pp. 511–554.
- 758 Smith, A.L. (Ed.), *Theory and Practice of Emulsion Technology*, Academic Press, New York, 1976.
- 759 Nunez, G.A.; Rivas, H.J.; Rodriguez, D.J.; Layrisse, I.A. Development of a New Technology: Profiting from Temporary Setbacks During Scale-Up in *Proc. Ann. Tech. Conf. SPE*, Society of Petroleum Engineers: Richardson, TX, 1995, SPE paper 30337.
- 760 Ocean Studies Board; Marine Board; Transportation Research Board; National Research Council *Spills of Emulsified Fuels, Risks and Response*, National Academy Press: Washington, DC, 2001.
- 761 Sommerville, M. *Pure Appl. Chem.*, 1999, 71, 193–201.
- 762 Schramm, L.L.; Smith, R.G. *Canadian Patent* 1,265,463, Feb. 6, 1990.
- 763 Rimmer, D.P., Gregoli, A.A., Hamshar, J.A., Yildirim, E. Pipeline Emulsion Transportation for Heavy Oils in *Emulsions, Fundamentals and Applications in the Petroleum Industry*, Schramm, L.L. (Ed.), American Chemical Society: Washington, 1992, pp 295–312.
- 764 Plegue, T.H., Frank, S.G., Fruman, D.H., Zakin, J.L. *SPE Production Engineering*, 1989, 3, 181–187.
- 765 Lewis, V.E.; Minyard, W.F. Antifoaming and Defoaming in Refineries in *Foams, Fundamentals and Applications in the Petroleum Industry*, Schramm, L.L. (Ed.), American Chemical Society: Washington, DC, 1994, pp. 461–483.
- 766 Britt, K.W. (Ed.) *Handbook of Pulp and Paper Technology*, 2<sup>nd</sup> ed., Van Nostrand Reinhold: New York, 1970.
- 767 Biermann, C.J. *Essentials of Pulping and Papermaking*, Academic Press: San Diego, 1993.
- 768 Casey, J.P. (Ed.), *Pulp and Paper Chemistry and Chemical Technology*, 3<sup>rd</sup> ed., Wiley-Interscience: New York, 1980.
- 769 Pelton, R. *Pulp & Paper Canada* 1989, 90, T61–T68.
- 770 Bhardwaj, N.K.; Kumar, S.; Bajpai, P.K. *Coll. Surf. A*, 2004, 246, 121–125.

- 771 Lindstrom, T.; Soremark, C.; Heinegard, C.; Martin-Lof, S. *Tappi* **1974**, *57*, 94–96.
- 772 Allen, S.L.; Allen, L.H.; Flaherty, T.H. Defoaming in the Pulp and Paper Industry in *Defoaming Theory and Industrial Applications*, Garrett, P.R., Ed., Marcel Dekker: New York, 1993, pp. 151–175.
- 773 Briscoe, O.E. (Ed.) *Asphalt Rheology: Relationship to Mixture*, ASTM Spec. Publ. 941, American Society for Testing and Materials: Philadelphia, PA, 1987.
- 774 Prost, J.; Rondelez, F. *Nature* (Supplement) **1991**, *350* (18 April) 11–23.
- 775 Agg, T.R. *The Construction of Roads and Pavements*, 5<sup>th</sup> ed., McGraw-Hill: New York, 1940.
- 776 Wallace, H.A.; Martin, J.R. *Asphalt Pavement Engineering*, McGraw-Hill: New York, 1967.
- 777 *The Asphalt Handbook*; The Asphalt Institute: College Park, MD, 1965.
- 778 Muncy, H.W. (Ed.) *Asphalt Emulsions*, ASTM Publ. STP 1079, American Society for Testing and Materials: Philadelphia, PA, 1990.
- 779 Theander, K.; Pugh, R.J. *Coll Surf A*, **2004**, *240*, 111–130.
- 780 Porter, M.R. Antifoams for Paints in *Defoaming Theory and Industrial Applications*, Garrett, P.R. (Ed.), Marcel Dekker: New York, 1993, pp. 269–297.
- 781 Bentley, J. The Use of Oils and Fatty Acids in Paints and Surface Coatings in *Lipid technologies and applications*, Gunstone, F.D. and Padley, F.B. (Eds.), Dekker, New York, 1997, pp. 711–715.
- 782 Wicks, Z.W. Coatings In *Encyclopedia of Polymer Science and Technology*, Online edition, posted October 22, 2001, Wiley: New York, 2002.
- 783 Dziejak, J. *Food Technol.*, **1988**, *42*, 136–151.
- 784 Fitch, R.M. *Polymer Colloids: A Comprehensive Introduction*, Academic Press: San Diego, 1997.
- 785 Tauer, K. Heterophase Polymerization in *Encyclopedia of Polymer Science and Technology*, Online edition, posted April 15, 2003, Wiley: New York, 2002.
- 786 Anderson, C.D.; Daniels, E.S. *Emulsion Polymerization and Latex Applications*, Rapra Technology Ltd.: Shawbury, UK, Rapra Review Report Vol. 14, No. 4, 2003, 146 pp.
- 787 Antonietti, M.; Tauer, K. *Macromolecular Chem. Physics*, **2003**, *204*, 207–219.
- 788 Lovell, P.A.; El-Aasser, M.S. (Eds.) *Emulsion Polymerization and Emulsion Polymers*, Wiley: New York, 1997.
- 789 Gilbert, R.G. *Emulsion Polymerization: A Mechanistic Approach*, Academic Press: London, 1995.
- 790 Buscal, R.; Corner, T.; Stageman, J.F. (Eds.) *Polymer Colloids*, Elsevier: London, 1985.
- 791 Grady, M.C. Latex Technology in *Encyclopedia of Polymer Science and Technology*, Online edition, posted October 15, 2004, Wiley: New York, 2002.
- 792 Chern, C.-S. Microemulsion Polymerization in *Encyclopedia of Polymer Science and Technology*, Online edition, posted April 15, 2003, Wiley: New York, 2002.
- 793 Worrall, W.E. *Clays and Ceramic Raw Materials*, Applied Science Publishers: London, 1975.
- 794 Pugh, R.J.; Bergström, L. (Eds.) *Surface and Colloid Chemistry in Advanced Ceramics Processing*, Dekker: New York, 1994.
- 795 Brinker, C. J.; Shearer, G.W. *Sol-Gel Science: The Physics and Chemistry of Sol-Gel Processing*, Academic Press, New York, 1990.
- 796 Nguyen, H.M. *Not All Firefighting Foam Systems Are Created Equal!*; U.S. Coast Guard Marine Safety Center: Washington, DC, 1998; also on <http://www.bts.gov/smart/cat/foams.html>.
- 797 Corrie, J.G. Experimental Methods for the Study of Fire-Fighting Foams in *Foams*, Akers, R.J., Ed.; Academic: New York, NY, 1976, pp. 195–215.
- 798 Prud'homme, R.K.; Khan, S.A. (Eds.), *Foams: Theory, Measurements, and Applications*, Dekker: New York, 1996.
- 799 Fitch, F., Firefighting Foams in *Foams: Physics, Chemistry, and Structure*, Wilson, A.J. (Ed.), Springer-Verlag: London, 1989, pp. 207–225.
- 800 *Foam Systems*, Reliable Fire Equipment Company: Alsip, 2005, <http://www.reliablefire.com/foamfolder/foamsystems.html>.
- 801 Figueredo, R.C.R.; Sabadini, E. *Coll. Surf. A*, **2003**, *215*, 77–86.
- 802 Briggs, T. Foams for Firefighting in *Foams, Theory, Measurements, and Applications*, Prud'homme, R.K.; Khan, S.A. (Eds.), Dekker: New York, 1996, pp 465–509.
- 803 St. Angelo, A.J. A Brief Introduction to Food Emulsions and Emulsifiers in *Food Emulsifiers: Chemistry, Technology, Functional Proper-*

- ties and Applications, G. Charalambous, G. Doxastakis (Eds.), Elsevier, Amsterdam, 1989, pp. 1–8.
- 804 Bergenstahl, B.; Dickinson, E. (Eds.) *Food Colloids: Proteins, Lipids and Polysaccharides*, Spec. Publ., Vol. 192, Royal Society of Chemistry, Cambridge, 1997.
- 805 Dickinson, E. (Ed.) *Food Emulsions and Foams*, Roy. Soc. Chem., London, 1987.
- 806 Wan, P.J.; Cavallo, J.L.; Saleeb, F.Z.; McCarthy, M.J. (Eds.) *Food Emulsion and Foams: Theory and Practice*, Am. Inst. Chem. Eng., New York, 1990.
- 807 Dickinson, E.; Walstra, P. (Eds.), *Food Colloids and Polymers: Stability and Mechanical Properties*, Royal Soc. Chem., London, 1993.
- 808 Dickinson, E.; McClements, D.J., *Advances in Food Colloids*, Blackie Academic, London, 1999.
- 809 Dickinson, E. (Ed.) *Food Polymers, Gels and Colloids*, Royal Society Chemistry: Cambridge, 1991.
- 810 Bee, R.D.; Richmond, P.; Mingins, J. (Ed.) *Food Colloids*, Royal Society Chemistry: Cambridge, 1989.
- 811 Potter, N.N. *Food Science*, 4<sup>th</sup> ed., AVI Publishing Co., Westport, 1986.
- 812 Darling, D.F.; Birkett, R.J. *Food Colloids in Food Emulsions and Foams*, Dickinson, E. (Ed.), Roy. Soc. Chem., London, 1987, pp. 1–29.
- 813 Stainsby, G., *Food Polymers, Gels and Colloids – A Teacher's View in Food Polymers, Gels and Colloids*, Dickinson, E., Ed., Roy. Soc. Chem.: London, 1991, pp. 450–468.
- 814 Stainsby, G.; Dickinson, E. *L'actualité Chimique*, 1988, 3, 35–39.
- 815 Goff, H.D. *Int. Dairy J.* 1997, 7, 363–373.
- 816 Horne, D.S. *Milk as a Food Dispersion in Technological Applications of Dispersions*, McKay, R.B., Ed., Dekker: New York, 1994, pp. 499–538.
- 817 Dickinson, E. *Coll. Surf.* 1989, 42, 191–204.
- 818 Krog, N. *Food Emulsifiers in Lipid Technologies and Applications*, Gunstone, F.D.; Padley, F.B. (Eds.), Dekker: New York, 1997, pp. 521–534.
- 819 Hasenhuetti, G.L. *Design and Selection of emulsifiers in the Food Industry in Food Emulsion and Foams: Theory and Practice*, Wan, P.J.; Cavallo, J.L.; Saleeb, F.Z.; McCarthy, M.J. (Eds.) Am. Inst. Chem. Eng.: New York, 1990, pp. 35–43.
- 820 Kamel, B.S. *Emulsifiers in Food Additive User's Handbook*, Smith, J. (Ed.), Blackie: Glasgow, 1991, pp. 169–201.
- 821 Dickinson, E.; Euston, S.R., *Stability of Food Emulsions Containing both Protein and Polysaccharide in Food Polymers, Gels and Colloids*, Dickinson, E. (Ed.), Royal Society of Chemistry: London, 1991, pp. 132–146.
- 822 Enriquez, L. G.; Flick, G. J. *Dev. Food Sci.* 1989, 19, 235–334.
- 823 Pernell, C.W.; Foegeding, E.A.; Luck, P.J.; Davis, J.P. *Coll. Surf. A*, 2002, 204, 9–21.
- 824 Dalgleish, D.G. *Aspects of Stability in Milk and Milk Products in Food Colloids*, Bee, R.D.; Richmond, P.; Mingins, J. (Eds.), Royal Society of Chemistry, Cambridge, 1990, pp. 295–305.
- 825 Rousseau, D. *Food Res. Int.* 2000, 33, 3–14.
- 826 Sogo, Y.; Taneya, S.; Kako, M., *Whipping Cream Emulsifiers in Food Emulsifiers: Chemistry, Technology, Functional Properties and Applications*, G. Charalambous, G. Doxastakis (Eds.), Elsevier: Amsterdam, 1989, pp. 449–472.
- 827 Krog, N.; Barfod, N.M.; Sanchez, R.M., *J. Disp. Sci. Technol.* 1989, 10, 483–504.
- 828 Wilde, P.J. *Curr. Opinion Coll. Interface Sci.* 2000, 5, 176–181.
- 829 Campbell, I.J.; Jones, M.G. *Cream Alternatives in Lipid Technologies and Applications*, Gunstone, F.D.; Padley, F.B. (Eds.), Dekker: New York, 1997, pp. 355–368.
- 830 Perram, C.M.; Nicolau, C.; Perram, J.W. *Nature*, 1977, 270, 572–573.
- 831 Campbell, I.J.; Pelan, B.M.C., *The Influence of Emulsion Stability on the Properties of Ice Cream in Ice Cream*, W. Buchheim (Ed.), Int. Dairy Fed.: Brussels, 1998, pp. 25–36.
- 832 Krog, N., *The Use of Emulsifiers in Ice Cream in Ice Cream*, W. Buchheim (Ed.), Int. Dairy Fed.: Brussels, 1998, pp. 37–43.
- 833 Goff, H.D. *Int. Dairy J.*, 1997, 7, 363–373.
- 834 Kilara, A.; Keeney, P.G., *Development of Frozen Emulsions in Food Emulsifiers: Chemistry, Technology, Functional Properties and Applications*, G. Charalambous, G. Doxastakis (Eds.), Elsevier: Amsterdam, 1989, pp. 473–493.
- 835 Leser, M.E.; Michel, M. *Curr. Opinion Coll. Interface Sci.*, 1999, 4, 239–244.
- 836 Madden, J.K. *Ice Cream in Foams: Physics, Chemistry, and Structure*, Wilson, A.J. (Ed.), Springer-Verlag: London, 1989, pp. 185–196.

- 837 Flack, E. Butter, Margarine, Spreads and Baking Fats in *Lipid technologies and applications*, Gunstone, F.D. and Padley, F.B. (Eds.), Dekker, New York, 1997, pp. 305–327.
- 838 Gunstone, F.D. and Norris, F.A., *Lipids in Foods. Chemistry, Biochemistry and Technology*, Pergamon Press: New York, 1983.
- 839 Dziezak, J.D. *Food Technology*, 1988, 42, 172–186.
- 840 Widlak, N. *U.S. Patent* 6,447,833, Sept. 10, 2002.
- 841 McCoy, S.A. *U.S. Patent* 4,341,814, July 27, 1982.
- 842 Tan, C.T., Physical Chemistry in Flavor Products Preparation in *Flavor Technology: Physical Chemistry, Modification, and Process*, Ho, C-T; Tan, C-T; Tong, C-H. (Eds.), American Chemical Society: Washington, 1995, pp. 1–17.
- 843 Dickinson, E. Protein Adsorption at Liquid Interfaces and the Relationship to Foam Stability in *Foams: Physics, Chemistry, and Structure*, Wilson, A.J. (Ed.), Springer-Verlag: London, 1989, pp. 39–53.
- 844 Prins, A.; van't Riet, K. *Trends in Biotechnol.* 1987, 5, 296–301.
- 845 Johnson, A.H.; Peterson, M.S. *Encyclopedia of Food Technology*, Avi Publishing Co.: Westport, 1974.
- 846 Perkowitz, S. *New Scientist*, 2000, Dec–Jan., 58–61.
- 847 Shamsi, K.; Che Man, Y.B.; Yusoff, M.S.A.; Jinap, S. *J. Am. Oil Chem. Soc.* 2002, 79, 583–588.
- 848 Andres-Lacueva, C.; Gailard, M.; Lopez-Tamames, E.; Lamuela-Raventos, R.M. *J. Agric. Food. Chem.* 1996, 44, 3826–3829.
- 849 Andres-Lacueva, C.; Lamuela-Raventos, R.M.; Buxaderas, S.; Torre-Boronat, M.C. *J. Agric. Food. Chem.* 1997, 45, 2520–2525.
- 850 Pueyo, E.; Martin-Alvarez, P.J.; Polo, C. *Amer. J. Enol. Vitic.* 1995, 46, 518–524.
- 851 Brissonnet, F.; Maujean, A. *Amer. J. Enol. Vitic.* 1993, 44, 297–301.
- 852 Evans, D.E.; Sheehan, M.C. *J. Amer. Soc. Brewing Chemists*, 2002, 60, 47–57.
- 853 Hegarty, P.K. Beer Foam In *Foams: Physics, Chemistry, and Structure*, Wilson, A.J. (Ed.), Springer-Verlag: London, 1989, pp. 197–206.
- 854 C.W. Bamforth, *J. Sci. Food Agriculture*, 2000, 80, 1371–1378.
- 855 Yokoi, S.; Shigyo, T.; Tamaki, T. *J. Inst. Brew.*, 1996, 102, 33–37.
- 856 Bamforth, C.W. *J. Sci. Food Agric.* 2000, 80, 1371–1378.
- 857 Nunes, F.M.; Coimbra, M.A.; Duarte, A.C.; Delgadillo, I. *J. Agric. Food Chem.* 1997, 45, 3238–3243.
- 858 Sims, R.J., Spray Dried Emulsions in *Food Emulsifiers: Chemistry, Technology, Functional Properties and Applications*, G. Charalambous, G. Doxastakis (Eds.), Elsevier, Amsterdam, 1989, pp. 495–509.
- 859 Trezza, T.A.; Krochta, J.M. *J. Food Sci.*, 2000, 65, 658–662.
- 860 Blease, T.G.; Evans, J.G.; Hughes, L.; Loll, P. Surfactant Antifoams in *Defoaming Theory and Industrial Applications*, Garrett, P.R. (Ed.), Marcel Dekker: New York, 1993, pp. 299–323.
- 861 Knowles, D.A. (Ed.), *Chemistry and Technology of Agrochemical Formulations*, Kluwer Academic Publishers: Dordrecht, 1998.
- 862 Seaman, D. *Pesticide Science*, 1990, 29, 437–449.
- 863 Naylor, R.E.L. (Ed.), *Weed Management Handbook*, 9<sup>th</sup> ed., Blackwell Publishing: Oxford, 2002.
- 864 Ware, G.W.; Whitacre, D.M. *The Pesticide Book*, 6<sup>th</sup> ed., MeisterPro Information Resources: Willoughby, OH, 2004.
- 865 Rodham, D.K. *Curr. Opinion Colloid Interface Sci.* 2000, 5, 280–287.
- 866 Knoche, M. *Weed Research* 1994, 34, 221–239.
- 867 Crooks, R.; Joanicot, M.; Prud'Homme, R.K.; Coret, J. "Aqueous Suspension of Nanoparticles Comprising an Agrochemical Active Ingredient" *U.S. Patent Application* 20030013799, filed Jan. 16, 2003.
- 868 Krasovitski, B.; Kimmel, E.; Rozenfeld, M.; Amir, I. *J. Agric. Eng. Res.* 1999, 72, 177–185.
- 869 Choi, C.Y. Development and Evaluation of Aqueous Foam for Cold Protection in Greenhouses in *Proc. Ann. ASAE Meeting*, ASAE: St. Joseph, MI, 1999, paper 994168.
- 870 Choi, C.Y.; Zimmt, W.; Giacomelli, G. *HorTechnology*, 1999, 9, 654–661.
- 871 Choi, C.Y.; Giacomelli, G. *HorTechnology*, 1999, 9, 662–667.
- 872 Thiigs, B.J.; Wright, N. *U.S. Patent* 2,875,555, Mar. 3, 1959.
- 873 Butler, J.W. *U.S. Patent* 3,669,898, June 13, 1972.
- 874 Cole, H.W.; Beattie, A.G. *U.S. Patent* 3,563,461, Feb. 16, 1971.
- 875 Bondoc, L.L.; Fitzpatrick, S. *J. Indus. Microbiol. Biotechnol.* 1998, 20, 317–322.

- 876 Lang, L.; Alexandridis, P. *Curr. Opinion Coll. Interface Sci.* **2000**, *5*, 132–143.
- 877 Cevc, G.; Marsh, D. *Phospholipid Bilayers*, Wiley: New York, 1987.
- 878 Marsh, D. *Handbook of Lipid Bilayers*, CRC Press: Boca Raton, FL, 1990.
- 879 Miller, R.; Kretschmar, G. *Adv. Colloid Interface Sci.*, **1991**, *37*, 97–121.
- 880 Agriculture and Agri-Food Canada, 2003, [http://res2.agr.ca/crda/indust/microscope\_e.htm].
- 881 McCabe, A.J.; Wilcox, D.T.; Holm, B.A.; Glick, P.L. *J. Pediatric Surgery* **2000**, *35*, 1687–1700.
- 882 Kallapur, S.; Ikegami, M.D. *Amer. J. Perinatology* **2000**, *17*, 335–344.
- 883 Hamm, H.; Kroegel, C.; Hohlfeld, J. *J. Respiratory Medicine* **1996**, *90*, 251–270.
- 884 Berger, R. Application of Antifoams in Pharmaceuticals in *Defoaming, Theory and Industrial Applications*, Garrett, P.R. (Ed.), Marcel Dekker: New York, 1993, pp. 177–192.
- 885 Malmsten, M. Surface Chemistry in Pharmacy in *Handbook of Applied Surface and Colloid Chemistry*, Holmberg, K. (Ed.), Vol. 1, Wiley, New York, 2001, pp. 3–38.
- 886 Kumar, N.; Chaubal, M.; Domb, A. J.; Majeti, R.K.N.V. Controlled Release Technology in *Encyclopedia of Polymer Science and Technology*, Online edition, posted December 13, 2002, Wiley: New York, 2002.
- 887 Barenholz, Y. *Curr. Opinion Colloid Interface Sci.* **2001**, *6*, 66–77.
- 888 Zasadzinski, J.A.; Kisak, E.; Evans, C. *Curr. Opinion Colloid Interface Sci.* **2001**, *6*, 85–90.
- 889 De, T.K.; Maitra, A. Particle Engineering of Drug-Loaded Nanoparticles and Their Potential Drug-Targeting Applications in *Handbook of Surface and Colloid Chemistry*, Birdi, K.S. (Ed.), CRC Press: Boca Raton, 1997, pp. 603–612.
- 890 Yang, L.; Alexandridis, P. *Curr. Opinion Colloid Interface Sci.* **2000**, *5*, 132–143.
- 891 Jones, M.-C.; Leroux, J.-C., *European J. Pharmaceutics Biopharmaceutics* **1999**, *48*, 101–111.
- 892 Sukhorukov, G.B. Designed Nano-Engineered Polymer Films on Colloidal Particles and Capsules in *Novel Methods to Study Interfacial Layers*, Möbius, D.; Miller, R. (Eds.), Elsevier: Amsterdam, 2001, pp. 383–414.
- 893 Ravi Kumar, M.N.V. *J. Pharm. Pharmaceutical Sci.* **2000**, *3*, 234–258.
- 894 Ducel, V.; Richard, J.; Saulnier, P.; Popineau, Y.; Boury, F. *Coll. Surf. A* **2004**, *232*, 239–247.
- 895 Lyons, R.T.; Carter, E.G. Lipid Emulsions for Intravenous Nutrition and Drug Delivery in *Lipid Technologies and Applications*, Gunstone, F.D. and Padley, F.B. (Eds.), Dekker: New York, 1997, pp. 535–556.
- 896 Donovan, B.W.; Reuter, J.D.; Cao, Z.; Myc, A.; Johnson, K.J.; Baker, J.R. *Antiviral Chem. Chemotherapy* **2000**, *11*, 41–49.
- 897 Dinsmore, A.D.; Hsu, M.F.; Nikolaidis, M.G.; Marquez, M.; Bausch, A.R.; Weitz, Science **2002**, *298*, 1006–1009.
- 898 Kriwet, B.; Walter, E.; Kissel, T. *J. Controlled Release* **1998**, *56*, 149–158.
- 899 Seki, J.; Sonoke, S.; Saheki, A.; Fukui, H.; Sasaki, H.; Mayumi, T. *Int. J. Pharm.* **2004**, *273*, 75–83.
- 900 Kuo, C.H.; Sheu, B.S.; Kao, A.W.; Wu, C.H.; Chuang, C.H. *Endoscopy* **2002**, *34*, 531–534.
- 901 Parak, W.J.; Boudreau, R.; Le Gros, M.; Gerion, D.; Zanchet, D.; Micheel, C.M.; Williams, S.C.; Alivisatos, A.P.; Larabell, C. *Adv. Mater.* **2002**, *14*, 882–885.
- 902 Otani, M.; Saito, M.; Yabe, A. *Textile Res. J.* **1985**, *55*, 582–588.
- 903 Mainkar, A.R.; Jolly, C.I. *Int. J. Cosmetic Sci.* **2001**, *23*, 59–62.
- 904 Lang, G.; Spengler, J. Surfactants in Cosmetic Formulations: Skin Irritancy and Physical Properties in *Proc., Internat. Federation Societies of Cosmetic Chemists (IFSCC) Congress*, Internat. Federation Societies of Cosmetic Chemists: Barcelona, 1986, pp. 25–37.
- 905 Ainsworth, S.J. *Chem. Eng. News* **1995**, *73*, 34–45.
- 906 Guesnet, J.; Breda, B.; Dersigny, D.; Carton, I.; Tran, V.; Morat, J.L. *J. Soc. Cosmet. Chem.* **1994**, *45*, 65–75.
- 907 Bhargava, H.N. *Drug Devel. Indus. Pharm.* **1987**, *13*, 2363–2387.
- 908 Coupland, K.; Nichols, J.A. Lipids Their Use in Personal Care Products in *Lipid Technologies and Applications*, Gunstone, F.D.; Padley, F.B. (Eds.), Dekker: New York, 1997, pp. 695–709.
- 909 Muyima, N.Y.O.; Zulu, G.; Bhengu, T.; Poplewell, D. *Flavour Fragr. J.* **2002**, *17*, 258–266.
- 910 Seiller, M.; Puisieux, F.; Grossiardi, J.L. Multiple Emulsions in Cosmetics in *Surfactants in Cosmetics*, 2<sup>nd</sup> ed., Reiger, M.M.; Rhein, L.D. (Eds.), Marcel Dekker: New York, 1997, pp. 139–154.

- 911 Sonnevile-Aubrun, O.; Simonnet, J.T.; L'Alloret, F. *Adv. Colloid Interface Sci.*, **2004**, 108-109, 145-149.
- 912 Magdassi, S. *Coll. Surf. A*, **1997**, 123, 671-679.
- 913 Forster, T.; von Rybinski, W. Applications of Emulsions in *Modern Aspects of Emulsion Science*, Binks, B.P. (Ed.), Royal Society of Chemistry: Cambridge, 1998, Chapter 12.
- 914 Sterzel, W. Toxicology of Surfactants Used in Cosmetics in *Surfactants in Cosmetics*, 2<sup>nd</sup> ed., Reiger, M.M.; Rhein, L.D. (Eds.), Marcel Dekker: New York, 1997, pp. 557-572.
- 915 Paez, A.; Howe, A. *Can. Chem. News*, **2004**, 56, 14-17.
- 916 Umbach, W. *Progr. Colloid Polym. Sci.*, **1998**, 111, 9-16.
- 917 Schueller, R.; Romanowski, P. *Cosmetics & Toiletries* **1998**, 113, 39-44.
- 918 Dahms, G.H. *SOFW-Journal*, **1995**, 121, 730-736.
- 919 Idson, B. *Drug & Cosmetic Industry*, **1993**, February, pp. 38-43, 72.
- 920 Hoffbauer, B. *Aerosol and Spray Report*, **1996**, 35, 508-515.
- 921 Johnson, R. *Chem. & Eng. News*, **1999**, 77, p. 31.
- 922 Kleiman, R.; Cummings, M.; Reinhardt, J. *Soap Cosmet.* **2000**, Feb., 31-33, 55.
- 923 Fox, C. *Cosmet. Toiletries*, **2001**, 116, 37-42.
- 924 Thompson, J. *Cosmet. Toiletries*, **2003**, 118, p. 96.
- 925 Schlossman, M. *J. Cosmet.Sci.* **1999**, 50, 105-109.
- 926 Benez, L.S.; Snowden, M.J.; Chowdhry, B.Z. Smart Materials in *Encyclopedia of Polymer Science and Technology*, Online edition, posted March 15, 2002, Wiley: New York, 2002.
- 927 Rosensweig, R.E. *Ferrohydrodynamics*, Cambridge University Press: Cambridge, 1985.
- 928 Odenbach S. *Magnetoviscous Effects in Ferrofluids*, Springer-Verlag: New York, 2002.
- 929 Odenbach S. (Ed.), *Ferrofluids: Magnetically Controllable Fluids and Their Applications*, Springer-Verlag: New York, 2003.
- 930 Ouellette, J. *The Industrial Physicist*, **2003**/ **2002**, Dec./Jan., 14-17.
- 931 Rajca, A. Magnetic Polymers in *Encyclopedia of Polymer Science and Technology*, Online edition, posted October 15, 2002, Wiley: New York, 2002.
- 932 Tao, R. (Ed.), *Electro-Rheological Fluids and Magneto-Rheological Suspensions*, World Scientific Publishing Co.: Hackensack, NJ, 2000.
- 933 Fehéra, J.; Filipcseia, G.; Szalmab, J.; Zrínyi, M. *Colloids Surfaces A*, **2001**, 183-185, 505-515.
- 934 Pei, Q.; Pelrine, R.E.; Kornbluh, R.D. *U.S. Patent* 6,812,624, Nov. 2, 2004.
- 935 Pelrine, R.E.; Kornbluh, R.D.; Eckerle; J.S. *U.S. Patent* 6,664,718, Dec. 16, 2003.
- 936 Lindler, J.E.; Anderson, E.H.; Regelbrugge; M. *U.S. Patent* 6,604,915, Aug. 12, 2003.
- 937 Banik; M.S. *U.S. Patent* 6,749,556, June 15, 2004.
- 938 Bag, D.S.; Alam S.; Mathur, G.N. *Smart Mater. Struct.* **2004**, 13, 1258-1262.
- 939 Matsuo E.S.; Tanaka, T. *Nature (London)* **1992**, 358, 482-485.
- 940 Snowden, M. *Science Spectra* **1996**, 6, 32.
- 941 Snowden, M.; Murray, M.J.; Chowdry, B.Z. *Chem. Ind.*, **1996**, 15 July, 531-534.
- 942 Obaidat, A.A.; Park, K. *Pharmaceutical Research* **1996**, 13, 989-995.
- 943 Kost, J.; Langerb, R. *Advanced Drug Delivery Reviews* **2001**, 46, 125-148.
- 944 Miyata1, T.; Asami, N.; Uragami, T. *Nature* **1999**, 399, 766-769.
- 945 Miyata, T.; Uragamia, T.; Nakamaeb, K. *Advanced Drug Delivery Reviews*, **2002**, 54, 79-98.
- 946 Wu, X.Y.; Yam, F. *U.S. Patent* 6,565,872, May 20, 2003.
- 947 Cote, G.L.; Pishko, M.V.; Sirkar, K.; Russell, R.; Anderson, R.R. *U.S. Patent* 6,485,703, Nov. 26, 2002.
- 948 Morris, G.E.; Vincent, B.; Snowden, M.J. *J. Colloid Interface Sci.* **1997**, 190, 198-205.
- 949 Loxley, A.; Vincent, B. *Colloid & Polymer Sci.* **1997**, 275, 1108-1114.
- 950 Vaidya, R.; López, G.; López, J.A. Nanotechnology in *Kirk-Othmer Encyclopedia of Chemical Technology*, Online edition, posted December 4, 2000, Wiley: New York, 1998.
- 951 Dickinson, E. *Curr. Opinion Colloid Interface Sci.*, **2003**, 8, 346-348.
- 952 Wang, Z.L. (Ed.) *Nanowires and Nanobelts, Materials, Properties, and Devices*, Vols. 1 and 2, Kluwer Academic: Boston, 2003.
- 953 Lefebvre, J-M. Nanocomposites, Polymer-Clay in *Encyclopedia of Polymer Science and Technology*, Online edition, posted March 15, 2002, Wiley: New York, 2002.
- 954 Takatori, K.; Tani, T.; Watanabe, N.; Kamiya, N. *J. Nanoparticle Res.* **1999**, 1, 197-204.
- 955 Novoselov, K.S.; Geim, A.K.; Morozov, S.V.; Jiang, D.; Zhang, Y.; Dubonos, S.V.; Grigorieva, I.V.; Firsov, A.A. *Science*, **2004**, 306, 666-669.

- 956 Wu, Y.; Xiang, J.; Yang, C.; Lu, W.; Lieber, C.M. *Nature*, **2004**, *430*, 61–65.
- 957 Whang, D.; Jin, S.; Wu, Y.; Lieber, C.M. *Nano Lett.*, **2003**, *3*, 1255–1259.
- 958 Yuan, Z.; Su, B. *Coll. Surf. A*, **2004**, *241*, 173–183.
- 959 Jacoby, M. *Chem. Eng. News*, **2003**, *81*, p. 9.
- 960 Misewich, J.A.; Martel, R.; Avouris, P.; Tsang, J.C.; Heinze, S.; Tersoff, J. *Science*, **2003**, *300*, 783–786.
- 961 Zheng, L.X.; O'Connell, M.J.; Doorn, S.K.; Liao, X.Z.; Zhao, Y.H.; Akhadov, E.A.; Hoffbauer, M.A.; Roop, B.J.; Jia, Q.X.; Dye, R.C.; Peterson, D.E.; Huang, S.M.; Liu, J.; Zhu, Y.T. *Nature Mater.* **2004**, *3*, 673–676.
- 962 Grumelard, J.; Taubert, A.; Meier, W. *Chem. Commun.*, **2004**, 1462–1463.
- 963 Kolesnikov, A.I.; Zanotti, J.; Loong, Chun.; Thiyagarajan, P.; Moravsky, A.P.; Loutfy, R.O.; Burnham, C.J. *Phys. Rev. Let.* **2004**, *93*, article 035503.
- 964 Britz, D.A.; Khlobystov, A.N.; Porfyrakis, K.; Ardavan, A.; Briggs, G.A.D., *Chem. Commun.*, **2005**, advance article posted online Nov. 18, 2004, 5 pp.
- 965 Britz, D.A.; Khlobystov, A.N.; Wang, J.; O'Neil, A.S.; Poliakov, M.; Ardavan, A.; Briggs, G.A.D. *Chem. Commun.*, **2004**, 176–177.
- 966 Srivastava, A.; Srivastava, O.N.; Talapatra, S.; Vajtai, R.; Ajayan, P.M. *Nature Mat.*, **2004**, *3*, 610–614.
- 967 Hinds, B.J.; Chopra, N.; Rantell, T.; Andrews, R.; Gavalas, V.; Bachas, L.G. *Science*, **2004**, *303*, 62–65.
- 968 Hashimoto, A.; Yorimitsu, H.; Ajima, K.; Suenaga, K.; Isobe, H.; Miyawaki, J.; Yudasaka, M.; Iijima, S.; Nakamura, E. *Proc. Nat. Acad. Sci. USA*, **2004**, *101*, 8527–8530.
- 969 Dagani, R. *Chemical & Engineering News*, **2002**, *80*, 38–39.
- 970 Daoud, W.A.; Xin, J.H. *J. Am. Ceram. Soc.* **2004**, *87*, 953–955.
- 971 Evans, T.J. Chemical Warfare in *Kirk-Othmer Encyclopedia of Chemical Technology*, Online edition, posted March 14, 2003, Wiley: New York, 2003.
- 972 Tadros, M.E.; Tucker, M.D. *U.S. Patent* 6,566,574, May 20, 2003.
- 973 Sandia National Laboratories, *Sudsy Brew Neutralizes Viral, Bacterial, Nerve Agents in Minutes*, <http://www.sandia.gov/media/cbwfoam.htm>, posted March 1, 1999.
- 974 Bureaux, J.G.; Purdon, J.G.; Cowan, G.; Cundasawmy, N.E. *Decontamination and Dispersion Suppressing Foam Formulation*, Canadian Patent Application 2,299,259, filed Feb. 25, 2000.
- 975 Cheng, T.; DeFranka, J.J.; Rastogib, V.K. *Chemo-Biological Interactions* **1999**, *119/120*, 455–462.
- 976 Lee, S.B.; Koepsel, R.; Stolz, D.B.; Warriner, H.E.; Russell, A.J. *J. Am. Chem. Soc.* **2004**, *126*, 13400–13405.
- 977 Bureaux, J.G.; Cundasamy, E.N.; Cowan, G.; Purdon, J.G. *Foam Formulations*, Canadian Patent Application 2,298,971, filed Feb. 18, 2000.
- 978 *Manual of Symbols and Terminology for Physicochemical Quantities and Units*; Appendix II; Prepared by IUPAC Commission on Colloid and Surface Chemistry; Butterworths: London, 1972 and 1978.
- 979 IUPAC Commission on Colloid and Surface Chemistry, *Pure Appl. Chem.* **1983**, *55*, 931–941.
- 980 IUPAC Commission on Colloid and Surface Chemistry, *Pure Appl. Chem.* **1985**, *57*, 603–619.
- 981 Carrière, G. *Dictionary of Surface Active Agents, Cosmetics and Toiletries*; Elsevier: Amsterdam, 1978.
- 982 Schramm, L. L. Glossary of Petroleum Emulsion Terms in *Emulsions: Fundamentals and Applications in the Petroleum Industry*; Schramm, L.L. (Ed.), American Chemical Society: Washington, DC, 1992, pp. 385–405.
- 983 Schramm, L. L. Foam Terminology in the Petroleum Industry in *Foams: Fundamentals and Applications in the Petroleum Industry*; Schramm, L.L. (Ed.), American Chemical Society: Washington, DC, 1994, pp. 487–535.
- 984 Schramm, L.L. Suspension Terminology in *Suspensions: Fundamentals and Applications in the Petroleum Industry*, Schramm, L.L. (Ed.), American Chemical Society: Washington, 1996, pp. 727–783.
- 985 Schramm, L.L. Glossary of Surfactant Terminology in *Surfactants, Fundamentals and Applications in the Petroleum Industry*, Schramm, L.L. (Ed.), Cambridge University Press: Cambridge, UK, 2000, pp. 569–611.
- 986 Kolesnikov, A.I.; Zanotti, J.; Loong, Chun.; Thiyagarajan, P.; Moravsky, A.P.; Loutfy, R.O.; Burnham, C.J. *Phys. Rev. Let.* **2004**, *93*, article 035503.

## Index

### a

- acacia gum 375
- acid rain 13
- acid-in-oil emulsion 268
- acidizing fluids 267
- acidizing foams 268
- acrylic resins 295
- activator 250, 256, 357
- active surfactant 357
- adhesion 338
- adhesives 297
- adsorption isotherm 14
- adsorption losses 275
- advancing front technique 75
- aerated emulsion 357
- aerating agent 357, 372
- aeration 357
- aerosol foods 344
- aerosol products 344
- aertor 358
- AFFF 299, 360
- AFFF foam 300
- AFFF-AR 359
- agar 303
- agglomerate flotation 358
- agglomeration flocculation 151
- aggregate 288
- aggregation 11, 117, 122, 129, 130, 138, 139, 145, 147 ff, 215, 307
- aging 358
- agitation type flotation cell 247
- agitator 358
- agitator ball mills 212, 358
- agricultural applications 301 ff
- agricultural colloids 321 ff
  - fungicide 321
  - herbicide 321
  - pesticide 321
  - plant blankets 321
  - shrub blankets 321
  - waste blankets 321
- agriculture 3
- air drilling fluids 265, 358
- air suspension coating 304
- airless spraying 358
- alcohol-resisting AFFF foam 299, 359
- alcohol-resisting aqueous film forming foam 299, 359
- algin 303
- alkyd 295
- alkyd resins 295
- amber 9
- amino resins 295
- amphiphiles 77
- amphoteric surfactant 359
- analysis of surfactants 81
- ancillaries 359, 367
- ancillary components 367
- Andrade equation 180
- aneasthetics 329
- animal glue 388
- anionic surfactant 359
- anisotropic particles 185
- annealing 291
- antagonistic action 216
- anthrax 353
- anti-bubbles 359
- anti-electrostatic agent 359
- antifoamers 220
- antifoaming 220 ff, 279, 296, 334
- antifoaming agent 359, 372, 373
- antifoams 292, 320
  - medical 328
- anti-redeposition agent 359
- antistatic agent 359
- aphrons 359, 382
- aqueous emulsion 359
- aqueous film forming foam 299, 360



- asphalt 287
- asphalt emulsion 288
- asphalt viscosity 287
- asphaltenes 139, 263, 287
- asymmetric particles 34
- atomizers 202
- Atterberg limits 360
- attractive forces 121, 305
  
- b**
- baby cream 341
- bad layer 377
- baked products 303, 315 ff
- ball mill 213, 214, 248, 294
- balloons 297
- Bancroft's rule 205, 360
- Bartsch test 47
- basic sediment and water 44, 360
- basic sediment and water test 225
- batch mixer 360
- batch treating 360
- Beaker test 360, 361
- bed knives 360
- beer foam 317
- benefication 360
- Bernauer 14
- BET 16, 17
- beverage emulsions 312
- bi-continuous system 361
- bi-layer 361
- bi-liquid foam 361
- bi-molecular film 277, 361
- binder 294, 295
- Bingham plastic model 174
- Bingham yield stress 150, 176
- bio-colloidal dispersion 361
- biological colloids 325 ff
  - biodegradable drug suspensions 325
  - blood 325
  - diagnostic suspensions 325
  - emulsion encapsulated drugs 325
  - gastrointestinal foam 325
  - polymer encapsulated drugs 325
  - spermicidal foam 325
  - vacuoles 325
  - vesicles 325
- biological warefare 353
- biological warefare blankets 241
- biology 3
- bitumen 102, 280, 287
- bitumen flotation 280
- bladders 297
- Blasius equation 196
- blast and fire suppression 354
- blast noise and pressure wave suppression blankets 241
- blast suppression 355
- blender test 361
- BLM 361
- blocking and diverting 275
- blood 196, 325
- blood viscosity 196
- blowing agent 361
- blue emulsions 342
- body clays 346
- Boltzmann distribution 103
- Born repulsion 119, 122
- bottle test 43 ff, 50, 361
- bottom settlings and water 360
- bottom solids and water 360
- bovine serum albumin 314
- bread 313, 316
- breaking 362
- bridging flocculation 134, 149 ff, 304, 306, 309
- brightening agents 362
- Brinkman equation 185
- Broughton-Squires equation 189
- Brownian motion 143, 145, 146
- Brownstock defoamer 286
- Brownstock washing 286
- Bruggeman equation 29
- Brunauer 16
- BS&W, see basic sediment and water
- BS&W test 225
- bubble electrophoresis 112
- bubble point 362
- builder 362
- bulk foam 362
- bulking agent 362
- buns 316
- butter 203, 312, 313
- butter-fat-spread 313
  
- c**
- cake 315, 319, 320
- cake batter 315
- calculation of phase inversion in concentrated emulsions 362
- Canadian oil-sands 280
- canned whipped cream 344
- Cannon-Fenske viscometer 161
- canola oil 312
- CAPICO 362
- capillary flow 61
- capillary number 269, 270, 272, 273

- capillary pressure 268
- capillary trapping 269
- capillary viscometer 160
- carbohydrates 314
- carbonated soft drinks 314
- carbonless copy paper 296
- carboxymethyl cellulose 310
- card-house structure 149, 175
- $\beta$ -carotene 313
- carpet cleaning foam 344
- carrageenan 303
- Carreau equation 192
- carrier flotation 257
- casein 302, 305, 306, 309, 310, 314, 320
- casein micelles 302
- casting suspensions 297
- catalyst 13 ff, 53
- cationic surfactant 362
- CCC, see critical coagulation concentration
- cell membrane 363
- cellulose fibres 285, 287, 292
- cellulose wood fibres 286
- cementing slurries 266
- centrifugal force 38 ff
- centrifugal separator 392
- centrifugation 30 ff, 38 ff, 278
- centrifuge 278
- centrifuge test 361
- ceramics 298
- ceramics manufacture 297 ff
- CFCs 344
- champagne foam 317
- characterization 13 ff
- characterization of emulsions
  - conductance 41
  - dyeing 41 ff
  - fluorescence 42
  - inversion 41
  - mixing 41
  - MRI imaging 42
  - texture 41
- characterization of foams 44
- characterization of suspensions 50
- charged interfaces 101 ff
- cheese 307, 315
- chemical flooding 271 ff
- chemical treatment 278
- chemisorption 16
- chitin 303
- chlorofluorocarbons 344
- chocolate 318, 363
- chocolate mousse emulsion 239, 363
- classification of surfactants 80
- classifier 363
- classifier mill 363
- clay 363
- clay colloids 148
- clay gel 176
- clay minerals 114, 131, 148, 212, 233
- clay particles 10
- clay suspensions 172
- cleaner 256
- cleaning processes 289
- cleaning solution 289
- cleansing creams 342
- clotted soap 383
- cloud point 363
- clustering 309
- cmc, see critical micelle concentration
- coacervation 304, 363
- coactive surfactant 364, 367
- coagulants 236
- coagulation 122, 124, 129, 130
- coal 248
- coalescence 12, 117, 138, 139, 215, 303, 364
- coated fabrics 297
- coated flooring 297
- coated insulation 297
- coated papers 297
- coatings 348
- cocoa beans 318
- cocoa butter 318
- coffee beverage foam 318
- coffee whiteners 306, 320
- co-ions 103
- cold creams 342
- collagen 319
- collectors 248, 249, 256, 293, 364
- colloid mill 202, 212 ff, 304, 364
- colloid stability 117 ff, 223, 364
- colloid titration 113
- colloidal 1 ff, 364
- colloidal gas aphrons 46, 227, 236, 277, 364, 382
- colloidal processing 364
- colloidal stability 144
- colloidosome 364
- column flotation 246
- comminution machines 212
- comminution methods 201
- common black film 126, 136
- complex coacervation 331
- concentric cylinder rheometer 155, 164
- concrete 297
- condensation 211

- condensation methods 365
- conditioners 338 ff
- conditioning 250
- conductivity 28 ff
- cone and plate rheometer 164, 166
- consistency 365
- contact angle 73 ff
  - sessile drop method 74
  - tilting plate method 74
- continuous centrifuge 39
- continuous phase 365
- contraceptive foams 328
- controlled release 323
- cookies 316
- corn oil 312
- cosmetic cream emulsions 341
- cosmetic creams 340
- cosmetic emulsions 341, 343
- cosmetic foams 344
- cosmetic skin care colloids 339 ff
- cosmeticeuticals 329
- cosmetics 339, 348
- co-surfactant 273, 365
- cottonseed oil 312
- Couette method 165
- Coulter counter 28
- Coulter counter technique 365
- counter-ions 101 ff, 103
- cream 31, 302, 306, 307, 309, 312, 315, 339, 343
- cream alternatives 308
- cream liqueurs 311
- creaming 30 ff, 36, 38, 117, 138, 139, 182, 303, 308, 365
- critical coagulation concentration 130 ff
- critical deposition velocity 365
- critical foaming oil saturation 154
- critical micelle concentration 82 ff
- crop protection 322
- corticosteroids 330
- crude oil 152, 263 ff
- crushing and grinding 248
- cuff layer 377
- curd 307
- curd-fibres 393
- cutting mill 212, 366
- cyclone cells 247
  
- d**
- Darcy's law 17, 197
- deacerator 366
- deactivators 251
- deaeration 366
- Dean-Stark method 44
- Debye dispersion forces 119
- Debye induction forces 121
- Debye–Hückel approximation 103 ff
- Debye–Hückel theory 104
- decontaminating foams 353 ff
- defoamers 279, 286, 359, 372
- defoaming 220 ff, 275, 279, 296, 315, 334
  - foods 320
- dehydration 219
- de-inking 292
- de-inking of fibres 287
- demulsibility 366
- demulsification 215 ff, 292
- demulsifier blends 218
- demulsifiers 216, 217, 278, 283, 366
- demulsifying agents 278
- demulsifying chemicals 283
- dense non-aqueous phase liquids 234
- depletion flocculation 134, 151, 306, 366
- depletion stabilization 134
- depressants 251, 366
- Derjuguin and Landau 122
- dermatological treatments 334
- de-salted oil 283
- desalter 366
- de-salting 114, 283
- detergency 94 ff, 289, 290, 291, 338
- detergency test 291
- detergent formulations 290
- detergent oil 367
- detergentless microemulsion 367
- detergents 95, 367, 338 ff, 394
  - antifoaming agents 290
  - antimicrobial agents 290
  - antiredeposition agents 290
  - bleaching agents 290
  - blueing agents 290
  - builders 290
  - enzymes 290
  - fluorescent whitening agents 290
  - foam boosters 290
  - starch 290
- deterstion 367
- de-wetting 367
- diagnosis 334
- diagnostic colloids 334 ff
- diffuse double layer 102 ff
- diffuse electric double layer 104
- diglycerides 303, 310, 312, 320
- dilatant fluid 170 ff
- dipole-dipole 119
- dipole-induced dipole 119

- dipoles 119
  - dipping 298
  - discontinuous phase 368
  - diseases 329, 332
  - dish washing 221
    - commercial 291
  - disjoining pressure 127, 136, 303, 367
  - disjoining pressure apparatus 128
  - disjoining pressure isotherm 128, 137
  - disk attrition mill 367
  - disk mill 212, 367
  - dispersant 367
  - disperse, see internal phase
  - dispersed phase 368
  - dispersion 368
    - colloidal 368
    - fluid flow 368
    - groundwater 368
  - dispersion characterization 13
  - dispersion destruction 201 ff, 215 ff
  - dispersion forces 119 ff, 121, 368
  - dispersion hazards 229
  - dispersion inhibition 201 ff, 215 ff
  - dispersion medium 368
  - dispersion methods 368
  - dispersion preparation 201 ff
  - dispersion stability 11, 19, 117 ff
  - dissolved air flotation 238
  - DLVO 265, 304, 305, 309, 310, 312, 313
  - DLVO theory 115, 122 ff, 125, 127, 128, 130, 132
  - DNAPL 234, 368
  - double emulsions 5, 42, 332
  - double layer thickness 104
  - doughnuts 316
  - drag reducers 300
  - draves wetting test 368
  - dressings 303
  - Drew, Koo, and McAdams equation 196
  - drilling and completion 263
  - drilling and completion fluids 265 ff
  - drilling fluids 265, 278
  - drilling mud 172
  - droplet break-up 58 ff
  - drug-delivery carriers 331
  - drug-delivery vehicles 348
  - drugs 328, 333
  - dry reclamation 259
  - dry soup mixes 320
  - dust 13
  - dust-suppressing covers 241
  - dust-suppressing foam blankets 261
  - dynamic foam test 47 ff, 369
  - dynamic interfacial tension 70
  - dynamic surface tension 87
- e**
- eddy viscosity 158
  - egg white 310, 314
  - egg yolk 302, 309, 313
  - eggs 302
  - Eilers equation 189
  - Einstein's equation 183, 184
  - electric double layers 102 ff, 119
  - electrical charges in non-aqueous media 115
  - electrical dehydration 278
  - electrocoagulation 369
  - electrocoating 296
  - electrocratic 369
  - electrodialysis 114
  - electrokinetic 101 ff
  - electrokinetic phenomena
    - colloid vibration current 105
    - colloid vibration potential 105
    - electrokinetic sonic amplitude 108
    - electro-osmosis 105
    - electrophoresis 105
      - sedimentation potential 105
      - streaming potential 105
      - ultrasonic vibration potential (UVP) 105
  - electrolytic flotation 238
  - electron microscopy 43, 46
  - electro-osmotic flow 109
  - electrophoresis 109 ff
  - electrophoretic mobility 110, 281
  - electrophoretic retardation 110, 111
  - electrophoretic velocity 109
  - electroplating 291
  - electro-rheological (ER) materials 348
  - electrostatic desalters 219
  - electrostatic desalting 219
  - electrostatic forces 119 ff
  - electrostatic repulsion 122
  - electrostatic separators 283
  - electrostatic stabilization 295, 302
  - electrostatic treater 369
  - electrosteric stabilization 369
  - Ellis model 173
  - elutriation 369
  - embryo 369
  - emission and odour-suppressing cover 240
  - emission-suppressing cover 241
  - Emmett 14, 16
  - emollients 340, 369
  - emulsator 369
  - emulsibility 369

- emulsifiable concentrates 323
  - emulsification and imbibition 153
  - emulsifiers 89, 369
  - emulsifying 290
  - emulsifying activity index 204
  - emulsifying capacity 204
  - emulsion 369
    - food 308, 311
    - medical 328
  - emulsion breaking 219
  - emulsion carriers 332 ff
  - emulsion curd soap 393
  - emulsion drilling fluids 263, 265
  - emulsion flotation 257
  - emulsion for road paving 287 ff
  - emulsion interface 218
  - emulsion inversion 191, 203, 369
  - emulsion occurrences 224 ff
  - emulsion paint 296
  - emulsion polymerization 297
  - emulsion preparation 202 ff
  - emulsion products 224
  - emulsion stability 43 ff, 138
  - emulsion stream 278
  - emulsion test 370
  - emulsion treatment 278
  - emulsoid 370
  - encapsulation 331
  - energy barrier 123
  - Engler degree 163
  - engulfment 370
  - enhanced oil recovery 235, 270 ff
  - entering coefficient 153
  - environment 3
  - environmental applications 231
    - foams on polluted lakes and rivers 231
    - free gas bubbles in oceans, lakes and rivers 231
    - insecticide and herbicide formulations 231
    - muds, quicksand 231
    - oil spill emulsions 231
    - rock fragments in lava 231
    - sediment particles in oceans, lakes, rivers 231
    - solid particles in rain drops 231
    - solid silicates in magma 231
    - sulfide liquids in magma or lava 231
    - suspended soils and sediments 231
    - volatiles (water, CO<sub>2</sub>) in magma or lava 231
    - water and sewage treatment emulsions 231
  - environmental foam blankets 240
  - epoxy esters 295
  - epoxy resins 295
  - equivalent spherical diameter 370
  - ER materials 348
  - erythrocytes 325
  - estuarine environments 232
  - evanescent foam 370
  - exfoliants 346
  - exfoliating scrubs 345
  - expansion factor 370
  - external phase 3, 7, 9
  - extrusion 304
- f**
- facial creams 346
  - facial masks 346
  - falling ball viscometer 167
  - falling sphere viscometer 167
  - Fann viscometer 167
  - Fanning friction factor 195
  - fat content 307
  - fat crystals 312, 315
  - fat globules 306, 307, 308, 312
  - fatty acid soaps 370
  - fatty alcohol surfactants 370
  - ferrofluid 371
  - FFFP 299, 371
  - FFFP foam 300
  - fibre binders 297
  - filler 371
  - film balance 79
  - film flotation 246
  - film forming fluoro protein foam 371
  - film-flotation technique 75
  - film-forming fluoroprotein (FFFP, foam) 299
  - filter cake 298
  - filters 278
  - filtration 152, 278
  - fine tailings reclamation 260
  - finer migration 268, 270
  - fire 298
  - fire-fighting 263
  - fire-fighting foams 298 ff, 300
  - flammable vapour suppression 241
  - flavour microemulsions 318
  - flavour oils 319
  - floc flotation 257
  - flocculation 122, 124, 147 ff, 305
  - flocs 149 ff
  - flotation 37, 92 ff, 237, 280, 293
  - flotation cell 251, 293
  - flotation de-inking 292, 293

- flotation froths 227
- flowables 322
- flow-line treating 371
- fluid film 371
- fluidized bed 11
- flumes 243
- fluorocarbon surfactants 299
- fluoroprotein foam (FP) 299, 371
- fly knives 371
- foam 372
  - medical 328
- foam blankets 240, 261, 323, 324, 354, 355
- foam booster 372
- foam breakers 283, 359, 372
- foam destabilization 152
- foam drainage 141, 372
- foam drilling fluids 265, 372
- foam flooding 275, 372
- foam food products 314
- foam formation 141
- foam fractionation 372
- foam generators 266
- foam head 317
- foam inhibitors 220, 283, 373
- foam injection processes 275
- foam nozzle 299
- foam number 373
- foam occurrences 227
- foam over 373
- foam persistence 141
- foam preparation 209 ff
- foam preventatives 220
- foam products 227
- foam quality 373
- foam stability 47 ff, 142
- foam stability to oil 152 ff
- foam texture 373
- foam toppings 316
- foam-forming surfactants 152, 275
- foaminess 372
- foaming 290, 310
- foaming agent 91 ff, 210, 310, 314, 372
- foaming capability 141
- foaming capacity 304
- foaming power 46
- foam-stimulation fluids 267, 373
- foamy-oil production 270
- food 3
  - food colloids 301 ff, 305, 373
    - aerated icing 301
    - bread 301
    - butter 301
    - cakes 301
    - chocolate drinks 301
    - coffee creamers 301
    - cream liqueurs 301
    - creams 301
    - fruit drinks 301
    - hollandaise 301
    - ice cream 301
    - margarine 301
    - marshmallow 301
    - mayonnaise 301
    - meringue 301
    - milk 301
    - mousses 301
    - processed cheese 301
    - salad dressings 301
    - sauces 301
    - sausages 301
    - soft drinks 301
    - souffles 301
    - spreads 301
    - syrups 301
    - toppings 301
    - vegetable shortening 301
    - water ice 301
    - whippable toppings 301
    - whipped cream 301
  - food defoamers 315
  - food emulsifiers 303
  - food emulsions 202, 301 ff
  - food foams 301 ff
  - food hydrocolloids 304
  - food ingredients 304
  - food product applications 301 ff
  - food science 140
  - food suspensions 301 ff
  - Ford-cup seconds 163
  - FP 299, 371
  - fracturing and acidizing 267 ff
  - fracturing and stimulation 263
  - fracturing fluid emulsions 267
  - Frankfurters 319
  - free water 374
  - free-water knockouts 219, 374
  - freezing front 370
  - frictional coefficient 34
  - froth 253, 254, 374
  - froth flotation 246, 255, 374
  - frothers 248, 250, 293
  - frothing agent 374
  - fruit juices 314
  - fungicides 321
  - FWKO 374

**g**

ganglia 274  
 gangue 254  
 gas dispersions 372, 374  
 gas emulsions 209, 372, 374  
 gastrointestinal endoscopy 334  
 gel 177, 298, 303, 307, 319  
 gel foam 374, 394  
 gelatin 304, 315, 319, 388  
 geld 374  
 gelling foams 276, 277  
 geology 3  
 g-force 389  
 Gibbs adsorption equation 78  
 Gibbs-Marangoni effect 87  
 glass cleaning foam 344  
 gloves 297  
 gold number 136, 375  
 Gouy plane 120  
 Gouy-Chapman model 103  
 Gouy-Chapman theory 105  
 granule/gravel 375  
 gravitational forces 252  
 gravy mixes 320  
 greases 172, 288, 289  
 grinding 255, 294  
 grinding mill 213  
 guar 310  
 gum 303, 375  
 gum acacia 304  
 gum arabic 303, 375  
 gun barrel separator 375  
 gun barrel settler 219  
 Guth-Gold-Simha equation 186

**h**

Hadamard and Rycynski equation 36  
 Hagen–Poiseuille equation 195  
 hair conditioners 369  
 hair-styling mousse 344, 345  
 halogenated resins 296  
 Hamaker constant 121  
 hammer mill 375  
 hand cream 341, 342  
 hard-surface cleaning 291  
 Hatschek equation 189  
 hazards 229  
 heater/treaters 283  
 heating 278  
 heavy crude oil 273  
 Henry theory 111  
 herbicidal blankets 241  
 herbicides 321

Herschel-Bulkley model 174, 265  
 hetero disperse 375  
 heterocoagulation 148  
 high energy surface 375  
 high-pressure homogenizer 304  
 hindered settling velocity 37  
 HIOC 376  
 HLB 97, 206, 208, 218, 303, 333, 342, 376  
 HLB temperature 386  
 HOC 376  
 Höppler viscometer 167  
 Hofmeister series 132  
 hollandaise 302  
 hollow fibre apparatus 212  
 homogeneous nucleation temperature 376  
 homogeneous nucleus 369  
 homogenizers 212, 310, 376  
 homogenizing valve 202  
 horizontal wells 265  
 household 289  
 Hückel theory 110  
 humic matter 232  
 humic substances 233  
 hydration effects 132 ff  
 hydration forces 127, 132, 133  
 hydraulic fracturing 267  
 hydraulic mining 243, 244  
 hydrocolloids 308, 376  
 hydrocyclones 248, 278  
 hydrometer 32  
 hydrophile-lipophile balance 90, 206, 208,  
 218, 376  
 hydrophilic 376  
 hydrophobe 376  
 hydrophobic 376  
 hydrophobic forces 132  
 hydrophobic ionogenic organic compound  
 376  
 hydrophobic organic contaminant 376  
 hydrosol 377  
 hydrotransport 243  
 hydrotrope 377

**i**

ice cream 303, 306, 308, 309 ff, 319  
 ice cream stabilizers 310  
 iep, see isoelectric point  
 illite clay 233  
 imbibition 377  
 immersion cleaning 291  
 immersional wetting 377  
 impeller mills 294  
 improved oil recovery 272

- in situ* surfactant flooding 236  
*in situ* viscosity measurements 169  
 inclined plate settling 379  
 inclined tube settling 379  
 increase of volume upon foaming 46, 377  
 incremental oil recovery 272, 273  
 india ink 294  
 induced dipole-induced dipole 119  
 induced gas flotation 391  
 induced gas flotation (IGF) cells 278  
 industrial applications 223 ff  
 industrial cleaning process 289  
 industrial demulsification 217  
 inertial forces 252  
 initial knockdown capability 378  
 ink 294 ff  
 ink particles 292  
 insecticides 321  
 instant whipped cream 316  
 insulating foams 344  
 interaction energy 122 ff  
 interface emulsion 278, 377  
 interfacial polymerization 331, 332  
 interfacial rheology 193 ff  
 interfacial viscosity 91  
 intermicellar liquid 377  
 internal phase 4, 7, 9, 368  
 intravenous injection 332  
 inverse micelle 377  
 inversion 191, 203, 216, 378  
 invert emulsion 378, 389  
 invert emulsion fluids 265  
 invert-oil mud 378  
 ion adsorption 101  
 ion diffusion 101  
 ion dissolution 101  
 ionization 101  
 isocyanates 295  
 isoelectric point 113  
 isomorphic substitution 101
- j**
- Jar test 361, 378  
 jet impingement 378  
 jet mill 212, 378  
 jojoba oil 340
- k**
- kaolinite clay 148, 346  
 Karl Fischer titration 44  
 Keesom dispersion forces 119  
 Keesom forces 121  
 Kelvin equation 73  
 Kelvin tetrakaidecahedron 8  
 kinematic viscosity 161, 162  
 kinetic stability 117 ff, 378  
 kinetics 143  
 knockdown capability 378  
 knockout drops 378  
 Krafft point 83 ff, 379  
 kraft cooking 286  
 kraft lignin 286  
 kraft pulp mill bleaching 286  
 Krebs units 167  
 Krieger and Dougherty equation 188  
 Kugelschaum 210, 372, 374
- l**
- lace curtains 318  
 lacquers 295  
 lactic acid 307  
 lactoglobulins 306  
 lakes and oceans 232  
 lamella settling 379  
 lamellae 276, 277, 372  
 lamellar foam 379  
 lamellar liquid crystalline structures 340  
 lamellar phases 303, 313  
 laminae 372  
 laminar flow 35, 58 ff, 156, 379  
 Langmuir 14, 16  
 Langmuir film balance 79  
 lanolin 340  
 Laplace equation 17  
 Laplace flow 61  
 lard 313  
 laser ink 293  
 latex 295, 297, 379  
 lather 379  
 launderometer 380  
 laundry, commercial 291  
 lava 231  
 lead-zinc recovery 256  
 lecithins 302, 303, 310, 312, 313, 320  
 leukocytes 325  
 light scattering, see radiation scattering  
 light-scattering apparatus 25 ff  
 lip balms 344, 345  
 lipid 302, 303, 308, 340, 380  
 lipid bilayers 303  
 lipid drug emulsions 334  
 lipid film 380  
 lipophile 380  
 lipophilic 380  
 lipophilic drugs 332  
 lipophobe 380



- lipophobic 380
  - lipoproteins 302
  - liposomes 326 ff, 329, 330, 340, 345
  - lipstick 172, 176, 344, 345
  - liquid crystal 313
  - liquid film 380
  - liquid limit 380
  - liquifier 202
  - London dispersion forces 120
  - London interaction forces 368
  - London–van der Waals dispersion 122
  - London–van der Waals dispersion forces 121
  - London–van der Waals forces 119
  - loose emulsion 380
  - lotions 340, 343
  - low energy surface 381
  - low-calorie spread 313
  - lower plastic limit 387
  - lower-phase microemulsion 381
  - low-fat spread 313
  - low-shear flotation 246
  - low-shear type flotation cell 247
  - lubricating greases 289
  - lubricating oil 181
  - lubricity 288
  - lung surfactant 327, 328
  - lyocratic 381
  - lyophilic 2, 381
  - lyophobic 2, 11, 381
  - lyotropic series 132
- m**
- macroemulsion 274, 333, 342, 369, 381
  - macroemulsion flooding 273
  - magma 231
  - magneto-rheological (MR) materials 347
  - main active 381
  - main active surfactant 367
  - manufacturing 3, 285 ff
  - manufacturing and material science
    - aqueous polymer-type paints 285
    - asphalt (paving) emulsion 285
    - cellulose fibre pulp slurries 285
    - de-inking pulp slurries 285
    - detergent washing foam 285
    - fire-fighting foams 285
    - flotation de-inking froth 285
    - india ink 285
    - microemulsion metalworking oil 285
    - pigment-containing paints 285
    - textile dye foam 285
    - wood fibre brownstock foams 285
  - Marangoni effect 87, 91, 304
  - Marangoni surface elasticity 88
  - Margarine 312, 313
  - marine animals 303
  - marine colloids 381
  - marine oil spills 238 ff
  - Marsh funnel seconds 163
  - marshmallows 315
  - Martin diameter 19
  - materials science 3, 285 ff
  - mayonnaise 302, 304, 313
  - mechanical flotation cell 247
  - mechanical impact mills 212, 381
  - mechanical methods 219
  - mechanical syneresis 381
  - medical colloids 325 ff
    - biodegradable drug suspensions 325
    - blood 325
    - diagnostic suspensions 325
    - emulsion encapsulated drugs 325
    - gastrointestinal foam 325
    - polymer encapsulated drugs 325
    - spermicidal foam 325
    - vacuoles 325
    - vesicles 325
  - medicine 3
  - membrane potential 381
  - meningitis 334
  - meniscus 382
  - Mercury porosimetry 17, 18
  - meringue 315
  - metal cleaning 291
  - metallic coatings 295
  - metal-working 288 ff
  - meteorology 3
  - Metzner–Reed modified Reynolds number 96
  - micellar emulsion 382
  - micellar flooding 273
  - micelle structure 82
  - micelles 76, 82, 382
  - microemulsion flooding 273
  - microemulsion polymerization 297
  - microemulsions 97, 203, 273, 274, 289, 291, 323, 333, 342, 349, 382
  - microencapsulation 304, 323, 329 ff, 382
  - micro-foams 46, 227, 236, 277, 374
  - microgas emulsions 382
  - microgels 348
  - micronizing 383
  - microscopy 20
    - confocal 22
    - electron 22 ff
    - optical 20 ff

- microsyneresis 396
  - micro-visual studies 154
  - middle soap 383
  - middle-phase microemulsion 383
  - Mie theory 25
  - milk 31, 302, 306, 307, 315
  - milk casein 307
  - milk chocolate 319
  - milk fat 306, 312
  - milk proteins 312
  - milk solids-nor-fat 309
  - mill effluents 287
  - mineral flotation 86, 243, 245 ff
  - mineral processing 3, 92, 243 ff
  - mini-emulsion 383
  - mining 243 ff
  - mist drilling fluids 265
  - Mitchell foam quality 373
  - mixed micelles 382
  - mobility control 275
  - mobility reduction factor 143
  - monodisperse 383
  - monoglycerides 303, 309 ff, 320
  - monolayer 79
  - Montmorillonite clay 148, 233
  - Mooney equation 188
  - mortars 297
  - motionless mixers 394
  - motor oil additives 224
  - mousse emulsions 226, 230, 239, 363
  - mouthwashes 318
  - MR materials 347
  - MRI imaging 42, 45, 46, 48, 118
  - multiple emulsions 20, 42, 209, 215, 225, 332, 333, 342, 345, 383, 386, 398
  - mustard gas 353
- n**
- nail polishes 346
  - nano approach 349
  - nanodispersions 348 ff
  - nanoemulsions 349
  - nanofibres 350, 352
  - nanoparticle suspensions 349
  - nanoparticles 332, 335, 349
  - nanosuspensions 349
  - nanotechnology 348
  - nanotube filters 352
  - nanotubes 350 ff
  - nanowires 350, 352
  - NAPLs 234, 384
  - natural surfactants 280, 288, 339
  - nebulizers 202
  - negative sedimentation 391
  - Nelson-type emulsion 384
  - Nernst equation 102
  - Newton black film 127, 136
  - Newtonian fluids 158, 170, 171
  - Newton's law of viscosity 157
  - night cream 341
  - nitrified foam 384
  - no slip condition 161
  - non-aqueous media 115
  - non-aqueous phase liquid 234, 384
  - non-fat solids content 307
  - non-ionic surfactant 384
  - non-Newtonian dispersion 158
  - non-Newtonian fluid 170
  - non-protein-stabilized emulsions 312
  - nutrients 332
- o**
- oakes mixer 384
  - oceans 232
  - octanol-water partition coefficient 384
  - Oden's balance 32 ff
  - oil 384
  - oil assisted flotation 384
  - oil bank 273, 274
  - oil base mud 384
  - oil color 384
  - oil emulsion 385
  - oil emulsion mud 385
  - oil field emulsion 217, 278
  - oil hydrosol 385
  - oil mud 385
  - oil sand 6, 37, 39, 156, 159, 280
  - oil sands processing 280 ff
  - oil spill 226, 238 ff, 263
  - oil spill clean-up 239
  - oil spill dispersants 240
  - oil tolerance 152
  - oil wells 265 ff
  - oil-flotation 243
  - oil-ganglia 270
  - oil-in-water 4
  - oil-in-water-in oil 5
  - oil-tolerant foams 154
  - ointments 343
  - oleo oil 312
  - oleomargarine 312
  - oleophilic 385
  - oleophobic 385
  - Oliver-Ward equation 186
  - one-second criterion 137, 252
  - opacifiers 385

- ophthalmic ointment 328
- optical brighteners 385
- optical microscopy 43
- optimal salinity 99
- optimum salinity 385
- organoclays 213
- oriented-wedge theory 140, 205, 385
- orifice viscometer 163
- Orimulsion® 240, 279
- orthokinetic coagulation 146
- oscillation viscometer 168
- Oseen's law 34
- Ostwald ripening 215, 385
- Ostwald viscometer 160
- Ostwald-de Waele model 173
- overdosing 217
- overrun 304, 309
  
- p**
- paddle stirrer 202, 304
- painting 291
- paints 172, 177, 294 ff
- Pal and Rhodes equation 189
- paper fibres 293
- paper-making 285 ff
- paraffin-chain salts 77
- particle associations 175
- particle size in flotation 251
- particle-bubble encounter 252
- paucidisperse 386
- peanut butter 313
- pearlescent coatings 295
- pebble mill 213
- penicillin 328
- peptization 132, 386
- perikinetic aggregation 305
- perikinetic coagulation 145, 146
- permeability 13 ff, 17, 18, 197
- permeability damage 268
- permeability, natural materials 198
- personal care applications 289
- personal care colloids
  - chelating agents 340
  - co-solvents 340
  - creams 340
  - humectants 340
  - lotions 340
  - viscosity builders 340
- personal care foam aerosol 345
- personal care products 3, 337 ff
  - bath preparations 337
  - cosmetic cream 337
  - exfoliating scrubs 337
  - facial masks 337
  - hair conditioners 337
  - hair-styling aids 337
  - hair-styling mousse 337
  - lip balms 337
  - lip glosses 337
  - lipsticks 337
  - microemulsion hair dyes 337
  - shampoo foam 337
  - shampoos 337
  - shaving preparations 337
  - shaving-cream foam 337
  - skin care creams 337
  - skin care products 337
  - toothpastes 337
- pesticidal blankets 241
- pesticides 321 ff
- petroleum 3, 4, 6, 9, 61, 99, 115, 118, 139, 152, 156, 159, 217, 288, 300
- petroleum industry 259, 263 ff
  - asphalt emulsion 264
  - blocking and diverting foams 264
  - dispersions of asphaltenes in crude oils 264
  - distillation and fractionation tower foams 264
  - drilling fluid (mud) suspensions 264
  - emulsion drilling fluid 264
  - emulsion fuel emulsion 264
  - enhanced oil recovery *in situ* emulsions 264
  - fire-fighting foam 264
  - foam acidizing fluid 264
  - foam drilling fluid 264
  - foam fracturing and stimulation fluids 264
  - fuel oil end jet fuel tank (truck) foams 264
  - fuel-oil emulsions 264
  - gas-mobility control foams 264
  - heavy-oil pipeline emulsions 264
  - migrating fines during secondary and enhanced oil recovery 264
  - migrating fines in a reservoir 264
  - oil- and oil-sand flotation-process emulsions 264
  - oil-field surface facility sludges 264
  - oil-flotation process diluted froth emulsions 264
  - oil-flotation process froth 264
  - oil-flotation process froth emulsions 264
  - oil-sand slurries in bitumen recovery 264
  - oil-sands tailings ponds 264
  - oil-spill mousse emulsions 264

- producing oil-well and well-head foams 264
- producing (well-bore) foams in cold, heavy-oil recovery 264
- producing (well-head) emulsions 264
- producing (well-head) solids in conventional oil recovery 264
- producing (well-head) solids in primary heavy oil recovery 264
- sludges from acid stimulation treatments 264
- tanker bilge emulsions 264
- transportation fuel emulsion 264
- well cementing slurries 264
- well stimulation and hydraulic fracturing suspensions 264
- well-stimulation emulsions 264
- pH regulators 293
- pharmaceutical formulations 328
- pharmaceuticals 328, 329
- phase inversion temperature 91, 203, 208, 342, 386
- phase ratio 386
- phospholipids 302, 303, 313, 326, 327, 386
- photozone counter 386
- Pickering emulsions 76, 139 ff, 386
- Pickering O/W emulsion 141
- pies 313
- pigment 294, 295, 386
- pigment formulations 295
- pigment grind 386
- pin mills 202
- pipeline 243, 244
- pipeline flow 194
- pipeline transportation, petroleum 282 ff
- PIT 203, 208, 342, 386
- PIT method 91
- plasma 325
- plastic fluid 170 ff
- plastic limit 387
- plasticity index 387
- plasticity number 387
- plasticity/pseudoplasticity with yield stress 174
- Plateau borders 8
- platelets 325
- point of zero charge 113
- points 159
- Poiseuille equation 163, 195
- Poiseuille's law 161
- Poisson equation 103
- Poisson-Boltzmann equation 103
- polydisperse 387
- polydispersity 188
- polyelectrolyte 387
- polyester resins 295
- polymer 40
- polymer bridging 237, 387
- polymer charge patch 387
- polymer coatings, pharmaceutical 330
- polymer colloids 297
- polymer synthesis 297
- polymer-enhanced foams 276
- polymeric micelles 331
- polymer-thickened foams 266, 277, 387
- polysaccharides 303, 314, 317
- polysoap 387
- polysorbates 310, 314
- polyurethane foam 344
- pore 277, 387
- pore size distribution 17
- porosimetry 17
- porosity 13 ff
- porous flocs 149
- porous media 142
- porous media flow 197
- porous medium 388
- potash 256
- potential determining ions 102
- potential energy maximum 123
- potential energy minimum 124
- potential energy of repulsion 119 ff
- potential-determining ions 113
- pour point 388
- power-law model 173, 265
- preparation, food colloids 304
- pressure capillary viscometer 162
- primary minimum 127
- primary oil recovery 268
- printing inks 294
- propane-butane blends 344
- propeller-style mixer 213
- propellor-type stirrer 202
- protection 134, 388
- protective agents 134
- protective colloid 388
- protein colloid 388
- protein foam 299
- protein load 308
- proteins 302, 303, 306, 307, 314 ff, 320, 325, 327
- protein-stabilized emulsions 306 ff
- pseudoemulsion film 388
- pseudoemulsion film model 154
- pseudoplastic flow 176
- pseudoplastic fluid 170 ff

- pseudoplastic fluid with yield stress 170 ff
- pseudoplasticity 173 ff
- puff pastries 316
- pulp 286, 388
- pulp and paper industry 285 ff
- pulp fines and fibres 286
- pulp liquor 253
- pulping 293
  
- q**
- quats 388
- quicksand 172
  
- r**
- radiation scattering 24 ff
- raffinate 388
- rag layer 278, 377
- rapid coagulation 145
- ray layer 224, 225
- Rayleigh ratio 25
- Rayleigh theory 24
- RCF 389
- red blood cells 325
- Red sky 25
- reduced-fat spreads 313
- Redwood seconds 163
- refineries 283
- refining 263
- Reiner-Philippoff equation 173
- relative centrifugal force 389
- relative permeability 197
- rennet 307
- re-peptization 389
- repulsive forces 119 ff, 305
- reservoir recovery 263
- reservoirs, petroleum 268 ff
- residual oil 270, 273
- residual oil saturation 272
- resistazone counter 392
- resolution 389
- retinoids 329
- reverse emulsion 378, 389
- reverse micelles 389
- Reynolds number 34, 158, 195, 389
- rheological die 162
- rheological measurement 159 ff
- rheological methods
  - capillary viscometers 160
  - concentric cylinder viscometers 160
  - cone and plate viscometers 160
  - falling ball viscometers 160
  - orifice viscometers 160
  - oscillation viscometers 160
  - pressure capillary viscometers 160
  - pulse capillary viscometers 160
  - rotational methods 160
  - tube methods 160
- rheological models 173 ff, 183 ff
- rheology 155 ff
  - experimental considerations 182
- rheology of dispersions 183 ff
- rheomalaxic fluid 172
- rheomalaxis 178
- rheoplectic fluid 172
- rheopexy 177 ff
- Richardson equation 189, 190
- Richardson-Zaki equation 37
- ring-roller mills 212, 389
- rising bubble viscometer 168
- rivers 232
- road paving 288
- Robertson-Stiff model 174
- rocks 231
- roll crusher 212, 390
- roll mill 248, 390
- rolls 316
- roll-up 95
- Roscoe equation 185
- Ross-Miles test 47, 390
- rotor-stator homogenizers 202
- rougher 256
- roughing flotation 255
  
- s**
- safflower oil 312
- salad cream 304
- salad dressing 312, 313
- salt curve 390
- salting in/out 390
- sand 390
- saponification 390
- sarin nerve gas 353
- sauce béarnaise 309
- sausages 319
- Saybolt furoil seconds 163
- Saybolt universal seconds 163
- scalping flotation 254
- scavening flotation 255, 391
- Schulze-Hardy rule 130, 131, 216, 236, 391
- scraped-surface mixers 304
- SEAR 395
- Searle-type rheometer 164
- seawater 35, 145, 232, 239
- seaweed colloids 391
- seaweeds 303
- secondary oil recovery 268

- secondary surfactant 367
- sediment 391
- sedimentation 11, 30 ff, 50, 117, 138, 182, 232, 237, 391
- sedimentation coefficient 391
- sedimentation velocities 232
- sedimentation-equilibrium method 40
- sediments 231
- selective flocculation 233
- selective flotation 255, 256
- semi-synthetic metal-working oils 289
- sensing zone technique 28 ff, 392
- sensitization 134, 216, 392
- separator 219, 392
- septum 392
- serum proteins 306
- settling 278
- settling radius 370
- settling velocity 37
- settling vessel 218
- shampoos 338 ff, 344
- shaving foam 344, 345
- shear plane 108
- shear rate 157, 159, 170, 171, 343
- shear stress 157, 170
- shear-thickening fluid 172
- shear-thinning fluid 172
- sheet-forming 287
- shell seconds 163
- Sherman equation 190
- shortening 313
- Sibree equation 189
- sieve standards 23
- sieving 23
- silicone oil 392
- silicones 295
- Silly Putty® 174
- silt 392
- Simha equation 19, 185
- sink-float method 75
- sintering 392
- Sisko model 173
- sixth-power law 391
- size distribution 18 ff, 27
- size methods 20
  - centrifuge 20
  - electron microscope 20
  - elutriation 20
  - impingers 20
  - light scattering 20
  - micrometers/calipers 20
  - microscope 20
  - neutron scattering 20
  - permeability 20
  - sedimentation 20
  - sieves 20
  - turbidimetry 20
  - ultracentrifuge 20
  - ultramicroscope 20
  - X-ray diffraction 20
- skim tanks 278
- skimming 306
- skin 342
- skin cleaner 338
- skin creams 369
- sky, colour 24
- slip casting 297, 298, 392
- slugging compound 378
- slurry pipeline 243, 244
- slurry quality 392
- smart colloids 347 ff, 348
- Smoluchowski 145
- Smoluchowski theory 110, 111
- soap film 393
- soaps 77, 95, 393
- soil colloids 233
- soil remediation 234 ff, 277
- soil science 3
- soils 231, 393
- sol 10
- sol-gel processing 298
- solid foam products 297
- solid-particle films 139
- solubilizate 393
- solubilization 393
- solubilizing agent 393
- solvation forces 127
- solvent 294
- soman 353
- sorbitan esters 314
- soybean oil 312
- sparging 251
- spherical agglomeration 151
- spinning 298
- spinning cylinder method 110
- spinning oil 393
- spinning solution additive 393
- spotting agent 393
- spray cleaning 291
- spray cooling/chilling 304
- spray droplets 322
- spray drying 304, 315, 319
- spray-dried emulsions 320
- spraying 298
- spreadable fats 313
- spreading coefficient 153

- spreads 303
  - stability 11 ff
    - food colloids 304
  - stability criteria 129
  - stability ratio 145
  - stabilizing agents, food colloids 302
  - static foam test 47, 393
  - static mixer 394
  - stationary levels 109
  - steamflooding 269
  - Steiner angle 8
  - steric effects 132 ff
  - steric repulsion 305
  - steric stabilization 134 ff, 302, 304, 305, 394
  - Stern plane 108, 110, 120
  - stiff foam 394
  - Stokes diameter 370
  - Stokes' law 30 ff
  - strams and rivers 232
  - stratum corneum 342
  - subdivision 211
  - sublimation 394
  - subsidence 394
  - suds 96
  - suds control agents 394
  - sugar beet processing 320
  - surface area 13 ff, 53, 57 ff
  - surface coatings 294 ff
  - surface dilational viscosity 193
  - surface elasticity 86 ff, 193
  - surface
    - capillary rise 62
    - captive bubble 67
    - captive drop 67
    - drop shape methods 66
    - drop weight and volume methods 65
    - droplet pressure method 69
    - Du Noüy ring 65
    - interfacial tension 54 ff, 61 ff, 70 ff
    - maximum bubble method 69
    - oscillating jet method 67
    - pendant drop 66
    - sessile drop 67
    - spinning drop method 68
    - Wilhelmy plate 63
  - surface load 308
  - surface operations, petroleum 278 ff
  - surface potential 123
  - surface rheology 193 ff
  - surface shear viscosity 193
  - surface treating 263
  - surface treatment, petroleum 278 ff
  - surface viscosity 304, 314
  - surface-active 77
  - surfactant 6, 76 ff, 394
  - surfactant adsorption 85
  - surfactant analysis 81
  - surfactant classes 80
  - surfactant effectiveness 395
  - surfactant efficiency 395
  - surfactant enhanced aquifer remediation 395
  - surfactant flooding 235
  - surfactant solubility 83
  - suspended load 395
  - suspending power 395
  - suspension 395
    - medical 328
  - suspension concentrates 322
  - suspension occurrences 228
  - suspension preparation 211
  - suspension products 228
  - suspension stability 50 ff, 137
  - suspension surface, interfacial tension 71
  - suspenoids 395
  - suspo-emulsion 395
  - sweep efficiency 274, 275
  - sweep flocculation 395
  - swelling 395
  - swelling pressure 396
  - swollen micelle 382
  - syndet 396
  - syneresis 396
- t**
- tactoids 149, 396
  - tailings 258 ff, 263
  - tailings pipelines 258
  - tailings ponds 258
  - tailings slurry 187, 243
  - tall oil 396
  - Taylor equation 189
  - Teller 14, 16
  - tensides 77, 396
  - terminal settling velocity 31
  - terror agents and colloids 353
  - tertiary oil recovery 270 ff
  - textile cleaning 290
  - thermodynamic stability 396
  - thin film stability 126
  - thixotropic fluid 172
  - thixotropy 176 ff
  - Thomas equation 187
  - Thomas<sup>®</sup>-Stormer<sup>®</sup> viscometer 167
  - tight emulsion 396
  - toner particles 293

- toothed disc mills 202  
 toothpaste 172  
 toppings 306  
 toxic chemical blankets 241  
 transition velocity 397  
 transportation 263  
 transportation pipeline 244  
 treaters 219, 369, 397  
 triacylglycerols 340  
 tube methods 160  
 tubing 297  
 turbidity 24, 237  
 turbulence 137, 252  
 turbulent flow 35, 59 ff, 156, 397
- u**
- Ubbelohde viscometer 160  
 ultracentrifugation 38 ff  
 ultracentrifuge 40  
 ultramicroscopy 26 ff  
 ultrasonic dispersion 397  
 ultrasound generator 213  
 underbalanced drilling 265  
 upgraders 283  
 upgraders and refineries, petroleum 283  
 upgrading 263  
 upper plastic limit 380  
 upper-phase microemulsion 397  
 uralkyds 295
- v**
- vaccines 332  
 vacuoles 327  
 value-added process industries 285  
 van der Waals forces 121, 368  
 varnish 295  
 vegetable-fat spread 313  
 velocity gradient 397  
 versator 397  
 Verwey and Overbeek 122  
 vesicle carriers 329  
 vesicles 302, 313, 326 ff, 335, 397  
 virial expansions 186  
 viruses 325  
 viscoelastic films 139  
 viscoelasticity 178, 305  
 viscosity 155 ff, 171  
   cosmetic cream 343  
   food colloid 306, 309  
   foods 316, 319  
   ointment 328  
 viscosity common materials 158  
 viscosity index 180
- viscosity modifier 397  
 viscosity nomenclature 179 ff  
   absolute viscosity 179  
   apparent viscosity 179  
   differential viscosity 179  
   inherent viscosity 179  
   intrinsic viscosity 179  
   kinematic viscosity 179  
   reduced viscosity 179  
   relative viscosity 179  
   specific increase in viscosity 179  
 vitamins 332  
 VOCs 344  
 volatile methylsiloxanes 344  
 volume fraction 184  
 volume-restriction 135  
 votators 202, 313, 398  
 VX 353
- w**
- wash load 232, 395  
 washing 289, 293  
 washing de-inking 292  
 washing machines 291  
 waste papers 287  
 water and wastewater treatment 236 ff  
 water treatment 238  
 water-continuous spread 313  
 waterflooding 269, 270  
 water-in-oil 4  
 water-in-oil-in-water 5  
 way esters 340  
 Weber number 59, 60, 270  
 Weissenberg effect 178  
 well-head emulsions 278  
 well-head foams 279  
 well-head suspensions 279  
 well-stimulation 267 ff  
 wet foam 210  
 wet oil 398  
 wet reclamatin 259  
 wettability 73 ff, 85, 94, 197, 269, 272, 289  
   alteration 272  
   Amott-Harvey indices 75  
   sessile drop method 74  
   tilting plate method 74  
   wettability index 75  
 wetting agents 94  
 wetting hysteresis 398  
 whey 307, 398  
 whey protein 310  
 whey-off 398  
 whipped cream 308, 316



whipped cream foam 309  
whipped topping 316  
whipping 304, 310, 312, 315  
whipping agent 372  
white cells 325  
Wiegner's tube 32  
winding oil 398  
Winsor microemulsion 97  
Winsor type emulsions 398  
work of adhesion 95

**x**

xanthan 310  
xerogel 374

**y**

yellow-fat spread 313  
yield stress 170  
Young–Laplace equation 61, 72, 268  
Young's equation 73, 139, 268

**z**

Zahn seconds 163  
zero discharge 258  
zeta potential 108, 110, 113, 129, 237, 249,  
280, 281, 286, 295, 305  
zwitterionic surfactant 399